

# ETSI EN 300 392-3-3 V1.3.1 (2011-11)



**Terrestrial Trunked Radio (TETRA);  
Voice plus Data (V+D);  
Part 3: Interworking at the Inter-System Interface (ISI);  
Sub-part 3: Additional Network Feature  
Group Call (ANF-ISIGC)**

---

Reference

REN/TETRA-03207

---

Keywords

interworking, radio, TETRA, V+D

**ETSI**

650 Route des Lucioles  
F-06921 Sophia Antipolis Cedex - FRANCE

Tel.: +33 4 92 94 42 00 Fax: +33 4 93 65 47 16

Siret N° 348 623 562 00017 - NAF 742 C  
Association à but non lucratif enregistrée à la  
Sous-Préfecture de Grasse (06) N° 7803/88

---

**Important notice**

Individual copies of the present document can be downloaded from:

<http://www.etsi.org>

The present document may be made available in more than one electronic version or in print. In any case of existing or perceived difference in contents between such versions, the reference version is the Portable Document Format (PDF). In case of dispute, the reference shall be the printing on ETSI printers of the PDF version kept on a specific network drive within ETSI Secretariat.

Users of the present document should be aware that the document may be subject to revision or change of status. Information on the current status of this and other ETSI documents is available at

<http://portal.etsi.org/tb/status/status.asp>

If you find errors in the present document, please send your comment to one of the following services:

[http://portal.etsi.org/chaicor/ETSI\\_support.asp](http://portal.etsi.org/chaicor/ETSI_support.asp)

---

**Copyright Notification**

No part may be reproduced except as authorized by written permission.  
The copyright and the foregoing restriction extend to reproduction in all media.

© European Telecommunications Standards Institute 2011.  
All rights reserved.

**DECT™**, **PLUGTESTS™**, **UMTS™** and the ETSI logo are Trade Marks of ETSI registered for the benefit of its Members.  
**3GPP™** and **LTE™** are Trade Marks of ETSI registered for the benefit of its Members and of the 3GPP Organizational Partners.  
**GSM®** and the GSM logo are Trade Marks registered and owned by the GSM Association.

# Contents

Intellectual Property Rights .....	9
Foreword.....	9
1 Scope .....	11
2 References .....	12
2.1 Normative references .....	12
2.2 Informative references.....	13
3 Definitions and abbreviations.....	13
3.1 Definitions.....	13
3.2 Abbreviations .....	14
4 ANF-ISIGC stage 1 specification.....	15
4.1 Description .....	15
4.1.1 General description.....	15
4.1.2 Qualifications on applicability to TETRA basic services .....	16
4.2 Procedures .....	16
4.2.1 Provision/withdrawal.....	16
4.2.2 Normal procedures.....	16
4.2.2.1 Activation/deactivation/registration/interrogation .....	16
4.2.2.2 Invocation and operation.....	16
4.2.2.3 ANF-ISIGC - the service provider.....	16
4.2.2.3.1 Establishing the group call at the originating and controlling TETRA SwMI .....	17
4.2.2.3.2 Establishing the group call at a participating TETRA SwMI .....	18
4.2.2.3.3 Delaying the group call .....	20
4.2.2.3.4 Control of call time-out timers .....	20
4.2.2.3.5 Acknowledged group call procedures .....	21
4.2.2.3.6 Colliding calls.....	21
4.2.2.3.7 Maintenance of the group call .....	22
4.2.2.3.8 Termination of the group call .....	25
4.2.3 Exceptional procedures.....	25
4.2.3.1 Activation/deactivation/registration/interrogation .....	25
4.2.3.2 Invocation and operation.....	25
4.3 Interaction with other PISN supplementary services and PISN ANFs.....	26
4.4 Interaction with TETRA supplementary services and other TETRA ANFs .....	26
4.4.1 Calling Line Identification Presentation (SS-CLIP) .....	26
4.4.2 Connected Line Identification Presentation (SS-COLP) .....	26
4.4.3 Calling/Connected Line Identification Restriction (SS-CLIR).....	26
4.4.4 Call Report (SS-CR) .....	26
4.4.5 Talking Party Identification (SS-TPI).....	27
4.4.6 Call Forwarding Unconditional (SS-CFU) .....	27
4.4.7 Call Forwarding on Busy (SS-CFB) .....	27
4.4.8 Call Forwarding on No Reply (SS-CFNry).....	27
4.4.9 Call Forwarding on Not Reachable (SS-CFNrc).....	27
4.4.10 List Search Call (SS-LSC).....	27
4.4.11 Call Authorized by Dispatcher (SS-CAD).....	27
4.4.12 Short Number Addressing (SS-SNA) .....	27
4.4.13 Area Selection (SS-AS) .....	27
4.4.14 Access Priority (SS-AP) .....	27
4.4.15 Priority Call (SS-PC) .....	28
4.4.16 Call Waiting (SS-CW).....	28
4.4.17 Call Hold (SS-HOLD) .....	28
4.4.18 Call Completion to Busy Subscriber (SS-CCBS).....	28
4.4.19 Late Entry (SS-LE) .....	28
4.4.20 Transfer of Control (SS-ToC).....	28
4.4.21 Pre-emptive Priority Call (SS-PPC).....	28
4.4.22 Include Call (SS-IC) .....	29

4.4.23	Advice of Charge (SS-AoC) .....	29
4.4.24	Barring of Outgoing Calls (SS-BOC) .....	29
4.4.25	Barring of Incoming Calls (SS-BIC) .....	29
4.4.26	Discreet Listening (SS-DL) .....	29
4.4.27	Ambience Listening (SS-AL) .....	29
4.4.28	Dynamic Group Number Assignment (SS-DGNA).....	29
4.4.29	Call Completion on No Reply (SS-CCNR) .....	29
4.4.30	Call Retention (SS-CRT) .....	29
4.4.31	Additional Network Features - Inter-System Interface Individual Call (ANF-ISIIC) .....	30
4.4.32	ISI Short Data (ANF-ISISD) .....	30
4.4.33	ISI Mobility Management (ANF-ISIMM) .....	30
4.5	Interworking considerations .....	30
4.6	Static description of ANF- ISIGC using attributes .....	31
4.7	Overall SDL .....	32
5	ANF-ISIGC stage 2 specification.....	45
5.1	Functional model.....	45
5.1.1	Functional model description.....	45
5.1.2	Description of functional entities .....	46
5.1.2.1	ISI group call originating entity, FE1 .....	46
5.1.2.2	Originating SwMI CC application functional entity, FE1' .....	47
5.1.2.3	ISI group call controlling entity, FE2.....	47
5.1.2.4	Controlling SwMI CC application functional entity, FE2' .....	48
5.1.2.5	ISI group call participating entity, FE3 .....	48
5.1.2.6	Participating SwMI CC application functional entity, FE3' .....	49
5.1.2.7	ISI Calling MS Database entity (ITSI), FE4 .....	49
5.1.2.8	ISI Called Group Database entity (GTSI), FE5.....	49
5.1.3	Relationship of functional model to PSS1 basic call functional model .....	50
5.2	Information flow .....	50
5.2.1	Information flow diagrams .....	50
5.2.1.1	Successful group call set-up over ISI using ANF-ISIGC.....	51
5.2.1.2	Acknowledged group call set-up over ISI using ANF-ISIGC.....	64
5.2.1.3	Partial group call set-up over ISI using ANF-ISIGC .....	65
5.2.1.4	Delay of group call set-up over ISI using ANF-ISIGC .....	68
5.2.1.5	Interaction with an active group call .....	72
5.2.1.6	Unsuccessful group call set-up over ISI using ANF-ISIGC.....	74
5.2.1.7	Call Maintenance procedures - Request to transmit.....	79
5.2.1.8	Call maintenance procedures - Cease transmission.....	88
5.2.1.9	Call Maintenance procedures - Withdraw/Continue from an active group call .....	92
5.2.1.10	Call Maintenance procedures - Information flow to participating SwMI(s) .....	94
5.2.1.11	Call Maintenance procedures - Group call restoration over ISI using ANF-ISIGC.....	94
5.2.1.12	Call Disconnection procedures - Controlling SwMI disconnects the call.....	101
5.2.1.13	Call Disconnection procedures - Participating SwMI disconnects from the call .....	102
5.2.1.14	Call Disconnection procedures - Call Owner disconnects the whole call .....	104
5.2.2	Definitions of information flows .....	105
5.2.2.1	ISI_CALL RESTORATION.....	105
5.2.2.2	ISI_CALL RESTORATION Reject.....	106
5.2.2.3	ISI_CONNECT .....	107
5.2.2.4	ISI_DISCONNECT.....	107
5.2.2.5	ISI_ORIGINATING SETUP .....	108
5.2.2.6	ISI_INFO .....	108
5.2.2.7	ISI_INTERACT .....	109
5.2.2.8	ISI_POLL.....	109
5.2.2.9	ISI_REJECT.....	110
5.2.2.10	ISI_RELEASE .....	110
5.2.2.11	ISI_REROUTE .....	111
5.2.2.12	ISI_RESOURCE .....	111
5.2.2.13	ISI_SETUP.....	112
5.2.2.14	ISI_TX-CEASED.....	113
5.2.2.15	ISI_TX-CONTINUE.....	113
5.2.2.16	ISI_TX-DEMAND.....	114
5.2.2.17	ISI_TX-GRANTED .....	114

5.2.2.18	ISI_TX-INTERRUPT .....	114
5.2.2.19	ISI_TX-WAIT .....	115
5.2.2.20	VERIFY_GROUP .....	115
5.2.2.21	VERIFY_INDIV .....	115
5.3	Functional Entity Actions (FEAs) .....	116
5.3.1	FEA of FE1 .....	116
5.3.2	FEA of FE1' .....	117
5.3.3	FEA of FE2 .....	117
5.3.4	Functional entity actions of FE2' .....	120
5.3.5	FEA of FE3 .....	121
5.3.6	Functional entity actions of FE3' .....	123
5.3.7	Functional entity actions of FE4 .....	124
5.3.8	Functional entity actions of FE5 .....	124
6	ANF-ISIGC stage 3 specification .....	125
6.1	ANF-ISIGC description .....	125
6.2	ANF-ISIGC operational requirements .....	125
6.2.1	PISN connection oriented call related connection .....	125
6.2.1.1	Requirements on the originating SwMI .....	125
6.2.1.1.1	PSS1 SETUP message .....	125
6.2.1.2	Requirements on the group home SwMI .....	126
6.2.1.2.1	PSS1 DISCONNECT or PSS1 RELEASE COMPLETE message .....	126
6.2.1.3	Requirements on the controlling SwMI .....	126
6.2.1.3.1	PSS1 DISCONNECT or PSS1 RELEASE COMPLETE message .....	126
6.2.1.3.2	PSS1 SETUP message .....	126
6.2.1.3.3	PSS1 CONNECT message .....	127
6.2.1.4	Requirements on the participating SwMI .....	127
6.2.1.4.1	PSS1 DISCONNECT or PSS1 RELEASE COMPLETE message .....	127
6.2.1.4.2	PSS1 CONNECT message .....	128
6.2.1.5	Requirements on the originating SwMI with PSTN/ISDN/PISN incoming gateway .....	128
6.2.1.5.1	PSS1 SETUP message .....	128
6.2.2	PISN connection oriented, call independent connection .....	129
6.3	ANF-ISIGC coding requirements .....	130
6.3.1	TETRA ANF-ISIGC PDUs .....	130
6.3.1.1	PISN connection oriented call related connection .....	131
6.3.1.1.1	TETRA PDU giving complementary information in the PSS1 SETUP, PSS1 CONNECT or PSS1 FACILITY message .....	131
6.3.1.1.2	TETRA PDU giving complementary information in the PSS1 CONNECT or PSS1 FACILITY message .....	135
6.3.1.1.3	TETRA PDU giving complementary information in the PSS1 FACILITY message .....	137
6.3.1.1.4	TETRA PDU giving complementary information in the PSS1 DISCONNECT or PSS1 FACILITY message .....	145
6.3.1.1.5	TETRA PDU giving complementary information in the PSS1 DISCONNECT, PSS1 FACILITY or PSS1 RELEASE message .....	146
6.3.1.1.6	TETRA PDU giving complementary information in the PSS1 DISCONNECT or PSS1 RELEASE COMPLETE message .....	147
6.3.1.2	PISN connection oriented, call independent connections .....	148
6.3.1.2.1	TETRA PDU sent by the participating SwMI of the migrated user - used to initiate call restoration .....	148
6.3.1.2.2	TETRA PDU sent by the controlling SwMI - used to confirm call restoration .....	149
6.3.1.2.3	TETRA PDU sent by the controlling SwMI - used to reject call restoration .....	149
6.3.2	TETRA PDU information element coding .....	149
6.3.2.1	Additional information to existing information element at the ISI .....	150
6.3.2.1.1	Call status .....	150
6.3.2.1.1a	Call time-out, set-up phase .....	150
6.3.2.1.2	Call time-out .....	150
6.3.2.1.3	Disconnect cause information element .....	151
6.3.2.1.4	Temporary group basic migration profile .....	151
6.3.2.1.5	PDU type .....	152
6.3.2.1.6	SS-migration profile .....	152
6.3.2.2	New information elements used at the ISI .....	153
6.3.2.2.1	Call amalgamation .....	153

6.3.2.2.1a	Call resource time-out .....	153
6.3.2.2.2	Call diverted to dispatcher .....	153
6.3.2.2.3	Call owner request .....	153
6.3.2.2.4	Calling group identifier .....	154
6.3.2.2.4a	Calling party information present .....	154
6.3.2.2.5	Connected party SSI and extension .....	154
6.3.2.2.6	Controlling/originating/participating SwMI MNI .....	154
6.3.2.2.7	Critical connected party/requesting party/restoring party/transmitting party SSI and extension...	154
6.3.2.2.8	Critical user list .....	154
6.3.2.2.9	Disconnect type .....	155
6.3.2.2.10	Dispatcher acceptance .....	155
6.3.2.2.11	External group member identity .....	155
6.3.2.2.12	External subscriber number digits .....	155
6.3.2.2.13	External subscriber number length .....	156
6.3.2.2.14	External subscriber number parameter .....	156
6.3.2.2.15	Fail Cause .....	156
6.3.2.2.16	Group attachment indicator .....	157
6.3.2.2.16a	Group call SwMI type .....	157
6.3.2.2.17	Group information .....	157
6.3.2.2.17a	ISI-INFO type .....	158
6.3.2.2.17b	Linking group identifier .....	158
6.3.2.2.18	New calling party .....	158
6.3.2.2.19	Numbering plan identifier .....	159
6.3.2.2.20	Poll request type .....	159
6.3.2.2.21	Poll result identifier .....	159
6.3.2.2.22	Reject cause information element .....	159
6.3.2.2.23	Resource allocation .....	161
6.3.2.2.24	Resource indicator .....	161
6.3.2.2.25	Screening indicator .....	161
6.3.2.2.26	Security level at air interface/Security level used in other network .....	161
6.3.2.2.26a	Setup response time-out .....	161
6.3.2.2.27	Set-up type .....	162
6.3.2.2.28	Speech service chosen/requested/used .....	162
6.3.2.2.29	Speech services supported .....	162
6.3.2.2.30	SS-CLIR invoked for calling/transmitting/restoring/connected party .....	163
6.3.2.2.31	Temporary group member indication .....	163
6.3.2.2.32	Transmission Ceased .....	163
6.3.2.2.33	Type of number .....	164
6.3.3	PSS1 facility information element .....	164
6.4	ANF-ISIGC state definitions .....	165
6.4.1	States at the originating SwMI .....	165
6.4.1.1	IDLE .....	165
6.4.1.2	FORWARD CALL .....	165
6.4.1.3	WAIT CONNECT .....	165
6.4.1.4	DELAY ENTRY .....	166
6.4.1.5	DELAY GROUP CALL .....	166
6.4.1.6	CALL DISCONNECT .....	166
6.4.1.7	CALL RELEASE .....	167
6.4.2	States at the controlling SwMI .....	167
6.4.2.1	IDLE .....	167
6.4.2.2	GROUP CALL INITIATE .....	167
6.4.2.3	DELAY GROUP CALL .....	168
6.4.2.4	ACTIVE .....	168
6.4.2.5	Void .....	169
6.4.2.6	CALL RELEASE .....	169
6.4.3	States at the participating SwMI .....	169
6.4.3.1	IDLE .....	169
6.4.3.2	WAIT CONNECT .....	170
6.4.3.3	DELAY ENTRY .....	170
6.4.3.4	DELAY GROUP CALL .....	170
6.4.3.5	ACTIVE .....	171
6.4.3.6	CALL DISCONNECT .....	171

6.4.3.7	CALL RELEASE.....	171
6.5	ANF-ISIGC signalling procedures.....	172
6.5.1	Call set-up procedures.....	172
6.5.1.1	Forward set-up request and PISN called number sending.....	172
6.5.1.2	Group linking.....	172
6.5.1.3	Call request, information channel selection and PISN called number sending.....	172
6.5.1.4	Call confirmation and call characteristics notification by the originating and participating SwMI(s).....	173
6.5.1.5	Call confirmation indication and call connected by the controlling SwMI.....	174
6.5.1.6	Delay of call set-up.....	174
6.5.1.7	Failure of call establishment.....	175
6.5.1.8	Multiple calling parties.....	175
6.5.1.8.1	A new calling party appears at a SwMI not currently in the group call.....	175
6.5.1.8.2	A new, compatible, calling party appears at a SwMI where a group call is active.....	175
6.5.1.8.3	A new, compatible, calling party appears at an OSwMI where a group call is still in the setup phase.....	175
6.5.1.8.4	A new, compatible, calling party appears at an PSwMI where a group call is still in the setup phase.....	175
6.5.1.8.5	A new calling party requesting an emergency call appears at a SwMI where the existing call is not at an emergency priority.....	176
6.5.1.8.6	A new, non compatible, calling party appears at a SwMI where a group call is already active....	176
6.5.1.8.7	A new calling party appears at a CSwMI that only supports a single ISI-Originating-Setup.....	176
6.5.1.8.8	The sending of subsequent ISI-Originating-Setups to the CSwMI.....	176
6.5.1.9	Security level.....	177
6.5.2	Acknowledge group call.....	177
6.5.3	Call maintenance procedures.....	177
6.5.3.1	Transmission control procedures.....	177
6.5.3.2	Call modification and/or continuation.....	179
6.5.3.3	Call restoration.....	179
6.5.3.4	DTMF procedures.....	180
6.5.4	Call disconnection procedures.....	180
6.5.5	Call collisions.....	181
6.5.6	Mapping of PSS1 messages with ISI PDUs.....	181
6.6	ANF-ISIGC impact from interworking with ISDN/PISN/PSTN.....	183
6.6.1	Call set-up procedures.....	183
6.6.2	Call maintenance procedures.....	183
6.6.3	Call disconnection procedures.....	183
6.7	Protocol interaction between ANF-ISIGC and supplementary services and other ANFs.....	184
6.7.1	Call Forwarding Unconditional (SS-CFU).....	184
6.7.2	Call Authorized by Dispatcher (SS-CAD).....	184
6.7.3	Area Selection (SS-AS) and selected area number.....	185
6.7.4	Priority Call (SS-PC).....	185
6.7.5	Pre-emptive Priority Call (SS-PPC).....	185
6.7.6	Include Call (SS-IC).....	185
6.7.7	Call Retention (SS-CRT).....	185
6.7.8	Interactions with other supplementary services.....	186
6.8	ANF-ISIGC parameter values (timers).....	186

**Annex A (normative): Specification and Description Language (SDL) representation of procedures .....187**

A.1	SDL representation of an ANF-ISIGC entity at FE1.....	187
A.2	SDL representation of an ANF-ISIGC entity at FE2.....	191
A.3	SDL representation of an ANF-ISIGC entity at FE3.....	197

**Annex B (normative): Stage 2 description of the interactions between ANF-ISIGC and SS-CAD when invoked for the called group.....201**

B.1	Information flow diagrams.....	201
B.1.1	Group call set-up when SS-CAD is invoked for called group.....	201
B.2	Definition of information flows.....	212

B.2.1	ISI_THROUGH CONNECT .....	212
B.3	Functional Entity Actions (FEAs) .....	212
B.3.1	Functional entity actions of FE1 .....	212
B.3.2	Functional entity actions of FE1' .....	213
B.3.3	Functional entity actions of FE2 .....	213
B.3.4	Functional entity actions of FE2' .....	213
B.3.5	Functional entity actions of FE3 .....	214
B.3.6	Functional entity actions of FE3' .....	214
<b>Annex C (informative):</b>	<b>Static description of the TETRA group call bearer service, using attributes .....</b>	<b>215</b>
<b>Annex D (informative):</b>	<b>Definition of the ISI ROSE operation .....</b>	<b>216</b>
<b>Annex E (informative):</b>	<b>Signalling Diagram Examples .....</b>	<b>217</b>
E.1	Call Setup .....	217
E.1.1	Single calling party, no queuing for resources .....	217
E.1.2	Single calling party, some queuing for resources .....	218
E.1.3	Single calling party, some queuing for resources, different connect strategy .....	219
E.1.4	Single calling party, some queuing for resources, showing multiple releasing .....	221
E.1.5	Multiple calling parties, a new calling party is on a SwMI not currently in the call .....	223
E.1.6	Multiple calling parties the second calling OSwMI is ready first. The new setup from the second OSwMI is received while the CSwMI is delaying the call .....	224
E.1.7	Multiple calling parties the second calling OSwMI is ready first. The new setup from the second OSwMI is received while the CSwMI is activating the call .....	226
E.1.8	Multiple calling parties the second calling OSwMI is ready first .....	228
E.1.9	Multiple calling parties the second calling OSwMI is ready first. Shows parties not connected into the call that could have been .....	230
E.1.10	Multiple calling parties the second calling OSwMI is ready first .....	231
E.1.11	Multiple calling parties an OSwMI transitions back into a PSwMI .....	233
E.1.12	Multiple calling parties and no PSwMI .....	234
E.1.13	Multiple calling parties at the same SwMI .....	235
E.1.14	Successful Group Call Establishment. The CSwMI does not accept more than one calling party .....	236
E.1.15	Late Entry .....	237
E.1.16	A SwMI joins with a Connected Call .....	237
E.1.17	An emergency priority call to a group that is already in an active, non-emergency, call .....	238
E.1.18	A call collision at startup .....	239
E.1.19	Partial successful group call establishment, call is not accepted by a PSwMI .....	240
E.1.20	Unsuccessful group call establishment rejected by an OswMI .....	240
E.1.21	Unsuccessful group call establishment, the CSwMI cannot accept some parameters, such as <i>resource allocation</i> , in the ISI SETUP ACKNOWLEDGE PDU from an OswMI .....	241
E.1.22	Unsuccessful Group Call Establishment, OSwMI or Party times out .....	242
E.1.23	Unsuccessful group call establishment rejected by the CswMI .....	242
E.2	Call maintenance .....	243
E.3	Call termination .....	245
E.3.1	The release of a SwMI from a call .....	245
E.3.2	Call disconnection, as a result of a PSwMI disconnecting .....	245
E.3.3	Call disconnection by the CswMI .....	246
<b>Annex F (informative):</b>	<b>Justification for the recommended call connection strategies and control of which parties are in the call .....</b>	<b>247</b>
<b>Annex G (informative):</b>	<b>Bibliography .....</b>	<b>248</b>
<b>Annex H (informative):</b>	<b>Change Requests .....</b>	<b>249</b>
History .....		251



---

## Intellectual Property Rights

IPRs essential or potentially essential to the present document may have been declared to ETSI. The information pertaining to these essential IPRs, if any, is publicly available for **ETSI members and non-members**, and can be found in ETSI SR 000 314: *"Intellectual Property Rights (IPRs); Essential, or potentially Essential, IPRs notified to ETSI in respect of ETSI standards"*, which is available from the ETSI Secretariat. Latest updates are available on the ETSI Web server (<http://ipr.etsi.org>).

Pursuant to the ETSI IPR Policy, no investigation, including IPR searches, has been carried out by ETSI. No guarantee can be given as to the existence of other IPRs not referenced in ETSI SR 000 314 (or the updates on the ETSI Web server) which are, or may be, or may become, essential to the present document.

---

## Foreword

This European Standard (EN) has been produced by ETSI Technical Committee Terrestrial Trunked Radio (TETRA).

The present document is part 3, sub-part 3 of a multi-part deliverable covering the Voice plus Data (V+D), as identified below:

EN 300 392-1: "General network design";

EN 300 392-2: "Air Interface (AI)";

**EN 300 392-3: "Interworking at the Inter-System Interface (ISI)";**

EN 300 392-3-1: "General design";

EN 300 392-3-2: "Additional Network Feature Individual Call (ANF-ISIIC)";

**EN 300 392-3-3: "Additional Network Feature Group Call (ANF-ISIGC)";**

EN 300 392-3-4: "Additional Network Feature Short Data Service (ANF-ISISDS)";

EN 300 392-3-5: "Additional Network Feature for Mobility Management (ANF-ISIMM)";

TS 100 392-3-6: "Speech format implementation for circuit mode transmission";

TS 100 392-3-7: "Speech Format Implementation for Packet Mode Transmission";

TS 100 392-3-8: "Generic Speech Format Implementation";

ETS 300 392-4: "Gateways basic operation";

EN 300 392-5: "Peripheral Equipment Interface (PEI)";

EN 300 392-7: "Security";

EN 300 392-9: "General requirements for supplementary services";

EN 300 392-10: "Supplementary services stage 1";

EN 300 392-11: "Supplementary services stage 2";

EN 300 392-12: "Supplementary services stage 3";

ETS 300 392-13: "SDL model of the Air Interface (AI)";

ETS 300 392-14: "Protocol Implementation Conformance Statement (PICS) proforma specification";

TS 100 392-15: "TETRA frequency bands, duplex spacings and channel numbering";

TS 100 392-16: "Network Performance Metrics";

TR 100 392-17: "TETRA V+D and DMO specifications";

TS 100 392-18: "Air interface optimized applications".

NOTE: Part 3, sub-parts 6 and 7 (Speech format implementation), part 4, sub-part 3 (Data networks gateway), part 10, sub-part 15 (Transfer of control), part 13 (SDL) and part 14 (PICS) of this multi-part deliverable are in status "historical" and are not maintained.

<b>National transposition dates</b>	
Date of adoption of this EN:	7 November 2011
Date of latest announcement of this EN (doa):	29 February 2012
Date of latest publication of new National Standard or endorsement of this EN (dop/e):	31 August 2012
Date of withdrawal of any conflicting National Standard (dow):	31 August 2012

---

# 1 Scope

The present document defines the Terrestrial Trunked Radio system (TETRA) supporting Voice plus Data (V+D). It specifies:

- general design aspects (e.g. reference points, numbering and addressing, or protocol architecture);
- the interworking between TETRA networks;
- the interworking of TETRA networks with other networks, via gateways;
- the supplementary services applicable to the basic TETRA tele- or bearer services.

The TETRA V+D interworking - basic operation part defines the interworking between TETRA networks over the corresponding interface: the Inter-System Interface (ISI). It comprises the following sub-parts:

- ISI general design;
- Additional Network Feature - ISI Individual Call (ANF-ISIIC);
- Additional Network Feature - ISI Group Call (ANF-ISIGC);
- Additional Network Feature - ISI Short Data service (ANF-ISISD);
- Additional Network Feature - ISI Mobility Management (ANF-ISIMM);
- Speech Format Implementation for Circuit Mode Transmission;
- Speech Format Implementation for Packet Mode Transmission.

The present document is the ANF-ISIGC sub-part.

In analogy with ITU-T Recommendation I.130 [i.6], the stage one, stage two and stage three of the three level structure is used to describe the TETRA Inter-System Interface services as provided by European Private or Public Trunked Radio System operators:

- Stage 1, is an overall service description, from the service subscriber's and user's standpoint;
- Stage 2, identifies the functional capabilities and information flows needed to support the services described in stage 1; and

NOTE: The information flows in stage 2 have been drawn as Message Sequence Charts (MSC). Therefore PISN basic call information flows are also shown together with the ANF-ISIGC information flows.

- Stage 3, defines the signalling system protocols and switching functions needed to implement the services described in stage 1.

The present document details the Interworking Basic Operation of the Terrestrial Trunked Radio system (TETRA). Specifically this sub-part details the stage 1 aspects (overall service description) of the ANF-ISIGC as seen from the TETRA Switching and Maintenance Infrastructure point of view at the Inter-System Interface (ISI). It details the stage 2 aspects (functional partitioning) of ANF-ISIGC which includes the identification of the functional entities and the flows between them, and finally it details the stage 3 signalling protocols for the ANF-ISIGC services, i.e. the protocols at the relevant reference points between the functional entities defined in stage 2.

The ANF-ISIGC service specifies:

- TETRA Group Call Clear Speech over the ISI, acknowledged and unacknowledged;
- TETRA Group Call End-to-End Encrypted Speech over the ISI;
- TETRA Group Call Circuit Mode one slot data over the ISI;
- TETRA Group Call Circuit Mode one slot End-to-End Encrypted data over the ISI;

- TETRA Group Call Circuit Mode  $N \times 2,4$  kbit/s,  $N \times 4,8$  kbit/s or  $N \times 7,2$  kbit/s data, with  $N = 2, 3$  or  $4$ ;
- TETRA Group Call Circuit Mode  $N \times 2,4$  kbit/s  $N \times 4,8$  kbit/s or  $N \times 7,2$  kbit/s End-to-End Encrypted data, with  $N = 2, 3$  or  $4$ .

---

## 2 References

References are either specific (identified by date of publication and/or edition number or version number) or non-specific. For specific references, only the cited version applies. For non-specific references, the latest version of the reference document (including any amendments) applies.

Referenced documents which are not found to be publicly available in the expected location might be found at <http://docbox.etsi.org/Reference>.

NOTE: While any hyperlinks included in this clause were valid at the time of publication, ETSI cannot guarantee their long term validity.

### 2.1 Normative references

The following referenced documents are necessary for the application of the present document.

- [1] ETSI EN 300 172: "Private Integrated Services Network (PISN); Inter-exchange signalling protocol; Circuit-mode basic services [ISO/IEC 11572 (2000) modified]".
- [2] ETSI EN 300 392-1: "Terrestrial Trunked Radio (TETRA); Voice plus Data (V+D); Part 1: General network design".
- [3] ETSI EN 300 392-2: "Terrestrial Trunked Radio (TETRA); Voice plus Data (V+D); Part 2: Air Interface (AI)".
- [4] ETSI EN 300 392-3-1: "Terrestrial Trunked Radio (TETRA); Voice plus Data (V+D); Part 3: Interworking at the Inter-System Interface (ISI); Sub-part 1: General design".
- [5] ETSI EN 300 392-3-2: "Terrestrial Trunked Radio (TETRA); Voice plus Data (V+D); Part 3: Interworking at the Inter-System Interface (ISI); Sub-part 2: Additional Network Feature Individual Call (ANF-ISIIC)".
- [6] ETSI EN 300 392-3-5: "Terrestrial Trunked Radio (TETRA); Voice plus Data (V+D); Part 3: Interworking at the Inter-System Interface (ISI); Sub-part 5: Additional Network Feature for Mobility Management (ANF-ISIMM)".
- [7] ETSI EN 300 392-7: "Terrestrial Trunked Radio (TETRA); Voice plus Data (V+D); Part 7: Security".
- [8] ETSI EN 300 392-11-6: "Terrestrial Trunked Radio (TETRA); Voice plus Data (V+D); Part 11: Supplementary services stage 2; Sub-part 6: Call Authorized by Dispatcher (CAD)".
- [9] ETSI EN/ETSI ETS 300 392-12 (all parts): "Terrestrial Trunked Radio (TETRA); Voice plus Data (V+D); Part 12: Supplementary services stage 3".
- [10] ETSI EN 300 395-2: "Terrestrial Trunked Radio (TETRA); Speech codec for full-rate traffic channel; Part 2: TETRA codec".
- [11] ISO/IEC 11572: "Information technology - Telecommunications and information exchange between systems - Private Integrated Services Network - Circuit mode bearer services - Inter-exchange signalling procedures and protocol".
- [12] ISO/IEC 11574: "Information technology - Telecommunications and information exchange between systems - Private Integrated Services Network - Circuit-mode 64 kbit/s bearer services - Service description, functional capabilities and information flows".

- [13] ISO/IEC 11582: "Information technology - Telecommunications and information exchange between systems - Private Integrated Services Network - Generic functional protocol for the support of supplementary services - Inter-exchange signalling procedures and protocol".
- [14] ISO/IEC 11571: "Information technology - Telecommunications and information exchange between systems - Private Integrated Services Networks - Addressing".

## 2.2 Informative references

The following referenced documents are not necessary for the application of the present document but they assist the user with regard to a particular subject area.

- [i.1] ETSI EN 300 392-3-8: "Terrestrial Trunked Radio (TETRA); Voice plus Data (V+D); Part 3: Interworking at the Inter-System Interface (ISI); Sub-part 8: Generic Speech Format Implementation".
- [i.2] ETSI EN 300 392-9: "Terrestrial Trunked Radio (TETRA); Voice plus Data (V+D); Part 9: General requirements for supplementary services".
- [i.3] ITU-T Recommendation I.140: "Attribute technique for the characterization of telecommunication services supported by an ISDN and network capabilities of an ISDN".
- [i.4] ITU-T Recommendation I.210: "Principles of telecommunication services supported by an ISDN and the means to describe them".
- [i.5] ITU-T Recommendation Z.100: "Specification and Description Language (SDL)".
- [i.6] ITU-T Recommendation I.130: "Method for the characterization of telecommunication services supported by an ISDN and network capabilities of an ISDN".
- [i.7] ITU-T Recommendation V.110: "Support by an ISDN of data terminal equipments with V-Series type interfaces".
- [i.8] ITU-T Recommendation E.164: "The international public telecommunication numbering plan".
- [i.9] ITU-T Recommendation X.121: "International numbering plan for public data networks".

---

## 3 Definitions and abbreviations

### 3.1 Definitions

For the purposes of the present document, the following terms and definitions apply:

**controlling SwMI:** Switching and Management Infrastructure (SwMI) which sets up and maintains a call between two or more SwMIs

**foreign user:** user who is not a member of the called group

**group home:** home of the GTSI, i.e. the SwMI where the network code (MNC) is equal to that of the group (GTSI)

**individual home:** home of the MS's ITSI, i.e. the SwMI where the network code (MNC) is equal to that of the individual subscriber (ITSI)

**linking controlling SwMI:** SwMI that controls the linking of one of its own groups to one or more groups from other SwMIs

NOTE: The group linking controlling SwMI is the home SwMI of the linked groups.

**linking home SwMI:** See linking controlling SwMI.

**linking participating SwMI:** SwMI that participates in the group linking by linking (joining) one group to the group linking

**linked group:** linking of one or more group identities from different TETRA SwMIs which forms a multigroup across several TETRA SwMIs and where one of these is designated to be the home of the linked group

**originating SwMI:** SwMI from where the call originates, i.e. where the initial call set-up is detected

NOTE: Once the calling user has been connected, the originating SwMI becomes a participating SwMI.

**participating SwMI:** SwMI only participates in the call without controlling it and will always be the end point of the call, i.e. where the call is terminated

**served SwMI:** SwMI that is involved in a group call either as the originating SwMI, the controlling SwMI or as the participating SwMI, hence utilizing the ANF-ISIGC service

**transit SwMI:** within the context of a call, any SwMI through which the call passes, excluding the originating SwMI, controlling SwMI or participating SwMI(s), is known as a transit SwMI

NOTE: No members of the active call can not terminate at a transit SwMI.

**visited SwMI:** TETRA network which MNI is not equal to the user's MNI

## 3.2 Abbreviations

For the purposes of the present document, the following abbreviations apply:

AL	Ambience Listening
ANF	Additional Network Features
AoC	Advice of Charge
AP	Access Priority
AS	Area Selection
BIC	Barring of Incoming Calls
BOC	Barring of Outgoing Calls
CAD	Call Authorized by Dispatcher
CC	Call Control
CCBS	Call Completion to Busy Subscriber
CCNR	Call Completion on No Reply
CFB	Call Forwarding on Busy
CFNRc	Call Forwarding on Not Reachable
CFNRy	Call Forwarding on No Reply
CFU	Call Forwarding Unconditional
CLIP	Calling Line Identification Presentation
CLIR	Calling/connected Line Identification Presentation
CMCE	Circuit Mode Control Entity
COLP	Connected Line Identification Presentation
CR	Call Report
CRT	Call ReTention
CRV	Call Retention Value
CSwMI	Controlling Switching and Management Infrastructure
CW	Call Waiting
DGNA	Dynamic Group Number Assignment
DL	Discreet Listening
FE	Functional Entity
FEA	Functional Entity Actions
GHDB	Group Home Data Base
GTSI	Group TETRA Subscriber Identity
HOLD	call Hold
IC	Include Call
IHDB	Individual Home Data Base
IPE	In-band Parameter Exchange
ISDN	Integrated Services Digital Network
ISI	Inter-System Interface
ISIGC	Inter-System Interface Group Call
ISIIC	Inter-System Interface Individual Call

ISIMM	ISI Mobility Management
ISISD	ISI Short Data
ISISS	Inter-System Interface Supplementary Service
ITSI	Individual TETRA Subscriber Identity
LE	Late Entry
LSC	List Search Call
MM	Mobility Management
MNC	Main Network Code
MNI	Mobile Network Identity
MS	Mobile Station
MSC	Message Sequence Charts
NFE	Network Facility Extension
OSwMI	Originating SwMI
PC	Priority Call
PDU	Protocol Data Unit
PINX	Private Integrated services Network eXchange
PISN	Private Integrated Services Network
PPC	Pre-emptive Priority Call
PSS1	Private Integrated Signalling System Number 1
PSTN	Public Switched Telephone Network
PSwMI	Participating SwMI
QoS	Quality of Service
SAP	Service Access Points
SDL	Specification and Description Language
SNA	Short Number Addressing
SS	Supplementary Service
SSI	Short Subscriber Identity
SwMI	Switching and Management Infrastructure
ToC	Transfer of Control
TPI	Talking Party Identification
TSSI	Time Slot Sequence Integrity
VDB	Visitor Data Base
VGSSI	Visited Group Short Subscriber Identity

---

## 4 ANF-ISIGC stage 1 specification

### 4.1 Description

#### 4.1.1 General description

ANF-ISIGC enables point to multipoint calls to be set-up between TETRA users located in more than one TETRA Switching and Management Infrastructure (SwMI), over the Inter-System Interface (ISI). In support of this, the ANF-ISIGC which operates at the ISI, shall detect a request from the originating SwMI for establishing one point to multipoint TETRA group call service between two or more TETRA SwMIs.

For originating requests the ANF-ISIGC provides access to the user profiles for both the calling individual TETRA user as well as it provides access to the user profile of the called TETRA group. The information is used for routing purposes and call contention checking. ANF-ISIGC also forwards the group call indication to the participating TETRA SwMIs.

For the duration of the call, the ANF-ISIGC shall handle transmission control signalling from all participating TETRA SwMIs. This is to ensure that transmission granting is only given to one of the individual TETRA users participating in the group call according to the point to multipoint TETRA call procedures defined in EN 300 392-2 [3]. Additionally, ANF-ISIGC shall participate in call restoration when a TETRA user in the group call migrates to another TETRA SwMI.

ANF-ISIGC may also be used to transport group related supplementary services between TETRA SwMIs.

## 4.1.2 Qualifications on applicability to TETRA basic services

ANF-ISIGC is applicable to the following point to multipoint basic services as defined in EN 300 392-2 [3]:

- point to multipoint one slot TETRA clear mode speech;
- point to multipoint one slot TETRA end-to-end encrypted speech;
- point to multipoint one slot 2,4 kbit/s, 4,8 kbit/s or 7,2 kbit/s TETRA circuit mode data;
- point to multipoint end-to-end encrypted one slot 2,4 kbit/s, 4,8 kbit/s or 7,2 kbit/s TETRA circuit mode data;
- point to multipoint  $N \times 2,4$  kbit/s,  $N \times 4,8$  kbit/s or  $N \times 7,2$  kbit/s TETRA circuit mode data, with  $N = 2, 3$  or 4;
- point to multipoint end-to-end encrypted  $N \times 2,4$  kbit/s,  $N \times 4,8$  kbit/s or  $N \times 7,2$  kbit/s TETRA circuit mode data, with  $N = 2, 3$  or 4.

## 4.2 Procedures

### 4.2.1 Provision/withdrawal

ANF-ISIGC shall be permanently available or controlled by provision/withdrawal.

### 4.2.2 Normal procedures

#### 4.2.2.1 Activation/deactivation/registration/interrogation

ANF-ISIGC shall be permanently activated on provision and permanently deactivated on withdrawal.

Registration and interrogation are not applicable to this ANF.

#### 4.2.2.2 Invocation and operation

ANF-ISIGC is an extension of TETRA SwMI call control and PSS1 basic call control over an Inter-System Interface, as documented by EN 300 392-2 [3] and ISO/IEC 11572 [11], which replaces and adds certain procedures that PSS1 basic call control is unable to perform satisfactory for TETRA users. ANF-ISIGC is compatible with PISN inter-exchange signalling protocol as defined by ISO/IEC 11582 [13].

#### 4.2.2.3 ANF-ISIGC - the service provider

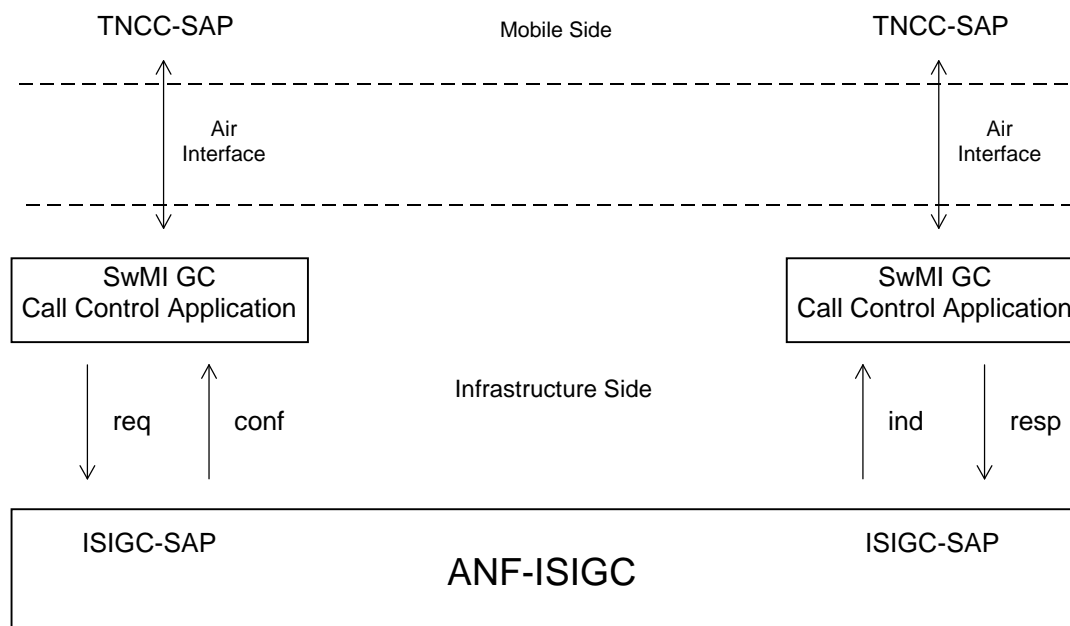
ANF-ISIGC shall be a SwMI V+D layer 3 (network layer) service provider. ANF-ISIGC shall offer services to SwMI CC applications.

The generic stage 1 service model is illustrated in figure 1. The control aspects of the services are defined in terms of primitives. The primitives are sent across the ISIGC Service Access Points (SAP) (ISIGC-SAPs) between the service provider and the service users. The ANF-ISIGC services use the following four generic service primitives:

- request (req);
- indication (ind);
- response (resp); and
- confirm (conf).

The service-specific primitives are defined for each service as part of the stage 1 service description in the following clauses. In the stage 1 descriptions, the ANF-ISIGC shall be seen as one entity.





**Figure 1: ANF-ISIGC stage 1 service model**

#### 4.2.2.3.1 Establishing the group call at the originating and controlling TETRA SwMI

ANF-ISIGC shall be invoked when a group call request has been received by the originating SwMI and analysis of the originating MS's migration profile and destination group identity (GTSI) has shown that the request is allowed and routing path to the group home SwMI exist.

The ANF-ISIGC entity shall analyse the originating MS identity and the destination group identity which shall give a result that points to one of the following three cases:

- 1) the home SwMI of the called user group is the originating SwMI and at least one of the members of the called group has migrated to another TETRA SwMI. The details of the migrated member(s) may be known in the database of the visited SwMI. Only one instance of the ANF-ISIGC shall be invoked, independent of the number of participating SwMI, i.e. more than one MS has migrated to a different TETRA SwMI;
- 2) the calling MS and the called user group has the same home SwMI, but the calling MS has migrated to another system. The details of the calling MS may be known in the database of the visited SwMI and shall be known in the database of the group home SwMI. The calling MS is a member of the called user group;
- 3) the home SwMI of the calling MS is the originating SwMI and the called user group belongs to a different TETRA SwMI than the originating SwMI. The calling user is located in the originating SwMI. The details of the called user group are known from the called group identity, i.e. the GTSI.

In cases (2) and (3), the ANF-ISIGC shall forward the call over the ISI to the group home SwMI CC application using the result of the analysis found in the originating SwMI. The group home is in case (2) determined by the VGSSI/GTSSI association and in case (3) determined by the Mobile Network Identity (MNI) of the GTSI.

In case (1) the originating SwMI, i.e. the SwMI in which the calling MS is located, is the group home SwMI.

The request for group call establishment transferred across the SAP from the originating SwMI CC application to the ANF-ISIGC entity shall include the following information used in the analysis for routing and call set-up purposes in the controlling SwMI:

- basic service information qualifying the bearer capability;
- called party identity specified by the GTSI;

- transmission control information, e.g. request to transmit or request that other MS may transmit;

NOTE 1: The controlling SwMI CC application normally gives the first permission to transmit to the calling MS when a new call has been set-up. However, the controlling SwMI CC application may also set-up the call without granting transmission to a specific user, e.g. the calling user application has indicated that it does not wish to transmit.

- priority of the call, e.g. emergency call priority.

After analysis of the called group profiles, the group home SwMI CC application shall inform the ANF-ISIGC entity of the analysis result. If the group call is accepted, the ANF-ISIGC entity shall analyse the called group identity. If the called group identity indicates that the group is linked to at least one other group identity where the home for the linked group is in a different TETRA SwMI, then the group call request shall be re-routed back to the originating SwMI with information indicating the linking home SwMI. The originating SwMI shall then once again forward the call request over the ISI. However this time, to the linking home SwMI CC application indicated by the group home SwMI. The details of the linked group are known in the database of the linking home SwMI. The linking home SwMI shall become the controlling SwMI for the group call. If the called group is not linked, the group home SwMI shall become the controlling SwMI for the call.

NOTE 2: The group home for the linked group is determined by the time of linkage.

An OSwMI may contain multiple parties who are trying to set-up a compatible group call at the same time.

The set-up of a group call may involve more than one OSwMI but only a single CSwMI.

An OSwMI may change back into a PSwMI, during call setup, if the call calling parties at the SwMI disconnect. The CSwMI is told when this happens.

Once the CSwMI has given the OSwMI permission to continue with the call the OSwMI may indicate that it is ready for the call to be connected. It is an implementation specific decision as to when the OSwMI decides to indicate this. Possible modes of acceptance are:

- 1) The OSwMI indicates acceptance if it has resources available to connect a calling party.
- 2) The OSwMI indicates acceptance if it has resources available to connect any party at the SwMI.
- 3) The OSwMI indicates acceptance if it has resources available to connect a calling party and a called group member at the SwMI.
- 4) The OSwMI indicates acceptance only when it has resources available to connect all group member parties at the SwMI.
- 5) The OSwMI indicates acceptable when it has resources available to connect a calling party and all group members at the SwMI.
- 6) If it has not already done so, the OSwMI indicates acceptance after a defined period.

For the most predictable call set-up mechanism mode 1 is recommended.

If the OSwMI is not able to indicate, within the time indicated by the Setup response time out information element, that it is ready to be connected when the CSwMI gives it permission to continue it may indicate the delay to the CSwMI.

#### 4.2.2.3.2 Establishing the group call at a participating TETRA SwMI

Once the controlling SwMI has been determined, the ANF-ISIGC entity shall analyse the call set-up information received in the forwarded set-up request and the location information for all group members.

NOTE 1: The controlling SwMI may change the priority and basic service information of the group call, e.g. if the controlling SwMI cannot support the call priority received from the originating SwMI.

The ANF-ISIGC entity shall convey the group call as an incoming group call indication across the SAP to the participating SwMI(s) CC application as well as to the originating SwMI CC application and the indication shall include the following information:

- basic service information qualifying the bearer capability;

- called party identity specified by the GTSI;
- transmission control information, e.g. allow request to transmit;
- priority of the call, e.g. emergency call priority.

The invoked SwMI(s) CC application (both the originating SwMI and the participating SwMI) shall evaluate if resources necessary (air interface, mobile and infrastructure resources) for the group call are available and that group members exist in the SwMI. If a group call can be performed in the invoked SwMI(s), the necessary resources shall be reserved.

It is an implementation specific matter to decide when the PSwMI is ready to be connected by the OSwMI. Possible modes of acceptance include:

- 1) The PSwMI indicates acceptance if it has resources available to connect at least one group member party at the SwMI.
- 2) The PSwMI indicates acceptance if it has resources available to connect all critical users at the SwMI.
- 3) The PSwMI indicates acceptance only when it has resources available to connect all group member parties at the SwMI.
- 4) If it has not already done so, the PSwMI indicates acceptance after a defined period.
- 5) The PSwMI indicates acceptance once it has determined that it has called group members present.

The recommended method is mode 5. This gives the most predictable call set-up mechanism.

If the PSwMI is not able to indicate, within the time indicated by the Setup response time-out information element, that it is ready to be connected when the CSwMI gives it permission to continue it may indicate the delay to the CSwMI.

The invoked SwMI(s) shall then indicate in a set-up response back to the controlling SwMI the mode of operation used to allocate resources, used for transmission over the ISI, during the group call. There are two modes of operation for a participating SwMI to allocating resources during the call maintenance phase:

- permanently allocated resources;
- temporary allocated resources.

For permanently allocated resources, all resources (air interface, mobile and infrastructure resources) reserved during call set-up shall be available for the duration of the active group call. For temporary allocation resources, the controlling SwMI shall for each new transmission ask each SwMI with temporary resources if they can participate in the transmission.

NOTE 2: The two modes of operation (permanently allocated resources/temporary allocated resources) when transmitting over ISI is not directly be connected to the air-interface trunking method. However, message trunking is needed in order to ensure "permanently allocated resource" mode.

The set-up response shall also indicating whether the group call is valid and whether the SwMI can support the communication type (normal, acknowledge or broadcast calls) indicated in the set-up indication.

NOTE 3: Negotiation of the service at set-up cannot be done for a group call (refer to EN 300 392-2 [3]). The only "negotiation" allowed is whether the invoked SwMI(s) accept the incoming call request, i.e. the service presented matches the service that can be provided. However, in case of non-acceptance of the communication type, the invoked SwMI may indicate which type of group call it can support (normal, acknowledge or broadcast). It is then up to the controlling SwMI to decide if the call is to be set-up to the specific SwMI. Otherwise, the invoked SwMI has no other alternative than to reject the call request if it cannot accept the indicated service at set-up.

The ANF-ISIGC entity shall collect all set-up responses, both acceptances and rejects, from the invoked SwMI(s) and convey them back to the controlling SwMI. The controlling SwMI CC application shall then determine whether the call can be set-up as either a complete or partial group call, if the group call shall be delayed or if the group call shall be released. If the group call is accepted, the originating SwMI and participating SwMI(s), shall be informed to connect the members of the group call. At this point in the call, the originating SwMI shall connect the calling user. The originating SwMI shall then change status to a participating SwMI and the called user shall be connected. The originating SwMI shall cease to exist.

A PSwMI may become an OSwMI during call setup if a new calling party appears at the PSwMI.

#### 4.2.2.3.3 Delaying the group call

The controlling SwMI CC application can determine to delay set-up of the group call if an invoked SwMI (both the originating SwMI and the participating SwMI) has responded to the group call set-up request with an indication that the call set-up should be delayed. The group call shall only be delayed if no reject cause has been received from another SwMI participating in the call that can result in group call release.

NOTE 1: A partial group call may be set-up even though an invoked SwMI wishes to delay the group call set-up.

When the controlling SwMI CC application determines to delay the group call, the ANF-ISIGC entity shall be informed. The ANF-ISIGC entity shall then inform all available SwMI(s) of the delay. Resources reserved by the originating SwMI and participating SwMI(s) during call set-up may be released. Only ISI channel resources shall be preserved. An ISI delay timer shall be initiated in the controlling SwMI when a group call is delayed. This timer is used to release ISI channel resources and delaying SwMI(s), if no response is received from the delaying SwMI(s) within a certain period of time.

A response that the call is allowed to proceed in the delaying TETRA SwMI shall be provided back to the ANF-ISIGC entity when this SwMI becomes available. The ANF-ISIGC entity shall convey the response back to the controlling SwMI. The controlling SwMI CC application shall then again determine whether the call can be set-up as either a complete or partial group call, if the group call shall continue to be delayed or if the group call shall be released. If the group call is accepted, the originating SwMI and participating SwMI(s), shall be informed to connect the members of the group call.

NOTE 2: The controlling SwMI may at any time decide to continue a delayed call set-up. When a delaying SwMI is ready to proceed with call set-up, it should be included in the call with the late entry service.

It is an implementation decision as to when the CSwMI decides that it can connect the call. Possible modes of call connection are:

- 1) The CSwMI connects the call as soon as any SwMI is "ready".
- 2) The CSwMI connects the call as soon as any OSwMI is "ready".
- 3) The CSwMI connects the call as soon as both an OSwMI and a PSwMI are "ready".
- 4) The CSwMI connects the call as soon as both a calling OSwMI and all PSwMIs are "ready".

For the most predictable operation mode 2 is recommended.

When the CSwMI connects the call it indicates to all OSwMIs which of those calling parties that are available and "ready" is to be the calling party of the call.

When a call is connected the CSwMI may send to any delaying SwMIs an indication that the call has connected. This allows those SwMIs to connect their parties, that are already "ready", in a timely manner.

#### 4.2.2.3.4 Control of call time-out timers

Controlling SwMI shall indicate the time allowed to the originating and participating SwMIs to make the needed preparation like channel reservations for the call by setting the Setup response time-out information element to a desired value when sending ISI-Setup-Initiate PDU. If the receiving SwMI is not able to respond to the ISI-Setup-Initiate by sending ISI-Setup acknowledge (because the SwMI is not yet ready to receive an ISI-Connect) within the time defined in the Set up response time-out information element the nominated SwMI shall send an ISI-Reject or ISI-Delay PDU to the CSwMI.

Call time-out for the call set-up phase should be defined by the controlling SwMI. The controlling SwMI CC application should indicate its time-out value to the originating SwMI. The originating SwMI CC application should then either use the indicated time-out value or define a larger value for its corresponding timer. The call time-out value for the call set-up phase shall be conveyed to the originating SwMI(s) following a forward set-up request.

The call time-out timer used during the maintenance phase of the call shall also be defined by the controlling SwMI CC application. The controlling SwMI CC application shall indicate this time-out value to the participating SwMI(s) (once the call is established the originating SwMI is also considered a participating SwMI). The participating SwMI(s) CC application should then either use the indicated time-out value or define a larger value for its corresponding timer. The call time out value shall be conveyed to the invoked SwMI(s) during call set-up.

**NOTE:** While the exchange of time-out values has been specified in the protocol, the use of the time-out values is optional. However, if the originating/participating SwMI(s) do not use the given timer values, the risk of call attempt failure (due to premature call establishment time-out) or call disconnection (due to premature call duration time-out) can be increased.

#### 4.2.2.3.5 Acknowledged group call procedures

For acknowledged group calls, the controlling SwMI shall request participating SwMI(s) to poll group members within a called group. The controlling SwMI CC application shall send a poll request to the ANF-ISIGC entity indicating whether the number or percentage of poll responses is wanted from each participating SwMI. The poll request shall be forwarded to all participating SwMI(s) supporting acknowledge group call.

**NOTE:** Polling of group members can only occur after the call has been established. However, it is implementation independent how many times a group may be polled during the call maintenance phase.

When polling group members, the controlling SwMI can decide either to let the call proceed immediately by giving the calling user permission to transmit before, during or after the participating SwMI(s) have responded to the polling request.

The ANF-ISIGC entity shall convey all received polling responses from the participating SwMI(s) back to the controlling SwMI CC application. After a certain period of time, all received responses shall be evaluated. The controlling SwMI may disconnect the call if an insufficient number of responses have been received.

It is an option of the controlling SwMI as how and when to inform the calling user or any other user of the polling result.

#### 4.2.2.3.6 Colliding calls

Call collisions can occur when two SwMIs simultaneously send a forward call set-up request to the same group. The two calls are then colliding:

- within the controlling SwMI when a forward group call set-up request is received within the window where the controlling SwMI is waiting for a call set-up responses to the same group from SwMIs that are to participate in the group call;
- within the originating SwMI when a group call set-up request is received within the window where the originating SwMI is waiting for a group call set-up request to the same group however with a different originating call identity than the one received.

**NOTE:** Collision occurring when two SwMIs try to seize the same resources may be solved by letting SwMIs own their own resources.

If the requested basic services are compatible for the colliding calls, then the controlling SwMI should amalgamate the calls and inform all participating SwMI(s) of call amalgamation in the group call connect request. Otherwise, the controlling SwMI call control application shall discard call set-up request received while waiting for call set-up responses from the participating SwMI(s).

Upon reception of a colliding group call set-up request, the originating SwMI shall accept the incoming call set-up request and discard its own outgoing call set-up request.

#### 4.2.2.3.7 Maintenance of the group call

##### Transmission control:

The ANF-ISIGC entity shall remain operational for the duration of the call, controlling the TETRA group call across the ISI using TETRA signalling messages defined as:

- transmission cease information, which requests the transmission to be ceased and informs all participating SwMIs about the transmission cease;
- transmission request information, where a participating SwMI requests the right to transmit and where all participating SwMIs operating in "temporary allocated resource" mode are acquired to reserve the relevant resources for the transmission;
- transmission delay information, when:
  - a participating SwMI with "temporary resources allocation" does not have any resources available, upon a resource reservation request; or when
  - the controlling SwMI is setting up the call to a new participating SwMI during transmission handling and the new participating SwMI request for a call set-up delay.
- transmission grant information which informs a participating SwMI that it has been granted transmission and informs all other participating SwMIs that transmission has been granted;
- transmission withdraw information, where a participating SwMI requests to withdraw from the call when resources are required to another call or a temporary pause is needed. The controlling SwMI shall determine whether the call can continue as a partial group call or if the complete group call shall be present to continue;
- transmission continue information, where a participating SwMI requests to continue with the withdrawn call;
- transmission interrupt information, where a participating SwMI requests current transmission to be interrupted due to higher priority and where all other participating SwMIs are informed about an interruption of the transmission in progress.

The ANF-ISIGC entity may contain a queuing mechanism for transmission request. When a TETRA user wishes to transmit, a transmission request shall be sent to the participating SwMI. The participating SwMI CC application shall then convey the transmission request to the ANF-ISIGC entity.

Upon reception of a request to transmit, the ANF-ISIGC entity shall evaluate if any conflicting transmission requests are received, e.g. only one participating SwMI shall be awarded the right to transmit while other transmission requests may be queued or rejected. If the transmission request is not queued or rejected, then all participating SwMI(s) without permanent allocated resources shall be requested by the ANF-ISIGC entity, to evaluate if necessary air interface, mobile and infrastructure resources are available for transmission.

If resources are available for transmission at the inquired participating SwMI(s), the necessary resources shall be reserved. The inquired SwMI(s) shall respond back to the ANF-ISIGC entity whether resources are available or not.

The ANF-ISIGC entity shall collect all responses, both acceptances, delay and rejects request, from the inquired SwMI(s) and evaluate if transmission can be performed as either a complete grant of transmission, partial grant of transmission or if the transmission request shall be rejected. The transmission request shall be rejected by ANF-ISIGC if important or critical SwMI(s) cannot participate in the transmission grant.

Each time a request to transmit is received in the controlling SwMI, the ANF-ISIGC entity should fetch group location information, to evaluate if new group members have registered to a SwMI not already participating in the group call. If new SwMI(s) are to be joined to the active call, a set-up request shall be sent to the new participating SwMI. The new participating SwMI will join the call according to normal call set-up procedures. However, the connect or release response sent from the controlling SwMI during call set-up shall be used together with the collected resource responses to evaluate if transmission can be granted to the requesting user.

### Transmission delay:

Transmission delay request are made by participating SwMIs either due to a participating SwMI with "temporary resources allocation" not having enough resources available, upon a resource reservation request or due to a new participating SwMI requesting call set-up delay. The actual decision to delay transmission granting shall be determined by the controlling SwMI.

NOTE 1: A partial grant of transmission may be performed even though one or more participating SwMIs do not have resources available.

When the controlling SwMI CC application determines that grant of transmission shall be delayed, the ANF-ISIGC entity shall be informed. The ANF-ISIGC entity shall release all new participating SwMIs, i.e. this is the same procedure as delay during call set-up, and inform each participating SwMI with temporary resources that transmission handling has ceased. Resources reserved by new participating SwMIs and participating SwMIs with temporary resources should be released. Only ISI channel resources shall be preserved. An ISI delay timer shall be initiated in the controlling SwMI upon delay. This timer is used to:

- release ISI channel resources to new PSwMI(s) and initiation of call release to all active SwMIs, if no response is received from the delaying SwMI within a certain period of time;
- grant transmission to the requesting user after a new set of resource reservation sequences has been performed and new PSwMI(s) have been set-up in the call; or
- grant transmission permission to another user. In this case, call set-up to the new PSwMI(s) and resource reservation sequences will be performed again.

When the delaying SwMI has the necessary resources available to perform transmission, a resource reserved or call set-up continue response shall be provided back to the ANF-ISIGC entity. The ANF-ISIGC entity shall convey the response back to the controlling SwMI CC application. The controlling SwMI CC application shall again set-up the call to new participating SwMIs and request for resource reservation in participating SwMIs with temporary resources. Once this has been performed transmission granting may be performed.

The controlling SwMI may at any time decide to continue a delayed transmission granting. When a delaying SwMI receives a transmission grant indication with transmission granted to another user, the delayed SwMI shall follow the indicated transmission when resources become available without informing the controlling SwMI that resources are now available.

### Service modification:

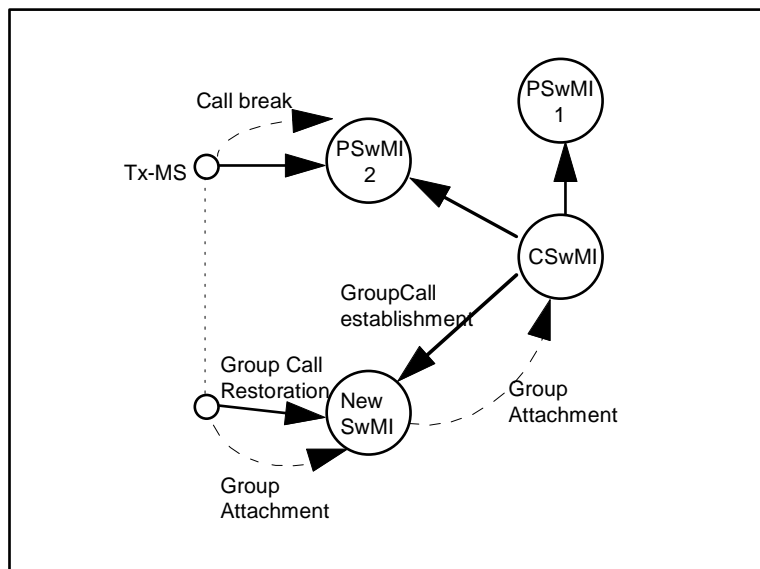
For the duration of a group call, modification to the services can be provided by the ANF-ISIGC entity. The service modification can only take place for services within the scope of this ANF. The service may be changed between any combination of one or more of the following:

- a point to multipoint one slot TETRA clear call (circuit mode data or speech) may be modified to a point to multipoint one slot TETRA end-to-end encrypted call;
- a point to multipoint one slot TETRA end-to-end encrypted call (circuit mode data or speech) may be modified to a point to multipoint one slot TETRA clear call;
- a 4-slots-per-frame circuit mode data call may be changed to a 1-slot, 2-slot or 3-slot call;
- a 3-slot circuit mode data call may be changed to a 1-slot or 2-slot;
- a 2-slot circuit mode data call may be changed to a 1-slot;
- a TETRA circuit mode data call (either clear or encrypted) with a data rate of 2,4 kbit/s, 4,8 kbit/s or 7,2 kbit/s may be changed to a different data rate, i.e.:
  - 2,4 kbit/s may be modified to 4,8 kbit/s or 7,2 kbit/s;
  - 4,8 kbit/s may be modified to 2,4 kbit/s or 7,2 kbit/s;
  - 7,2 kbit/s may be modified to 2,4 kbit/s or 4,8 kbit/s; or
  - to a circuit mode speech call.

- a TETRA circuit mode speech call (either clear or encrypted) may be changed to a circuit mode data call with a data rate of 2,4 kbit/s, 4,8 kbit/s or 7,2 kbit/s.

#### Call restoration:

When a TETRA user, active in a group call, migrates to a new SwMI from a participating SwMI (denoted in the following as the old SwMI) the group call shall be restored to the TETRA user following the call restoration procedures for group calls in EN 300 392-2 [3] and EN 300 392-3-5 [6].



**Figure 2: Group call restoration**

As shown in figure 2 the support of these air interface procedures demands the TETRA user to attach to the group on which it is active. The controlling SwMI call control application shall instruct the ANF-ISIGC entity to extend a group call over ISI to a new participating SwMI in the following cases:

- 1) when transmission is to be granted to a member of a group call and it has been determined, i.e. based on group attachment information, that the group call does not exist at the new participating SwMI;
- 2) when the migrated user has requested call restoration and it has been determined, i.e. based on call information, that the group call does not exist at the new participating SwMI;
- 3) in the case where the migrating TETRA user was the last member of the group at the old SwMI, the ANF-ISIGC entity shall clear the ISI group call path to the old SwMI.

When a user attaches to a group that is part of a linked group, the linking home SwMI will be informed of attachment as part of the ANF-ISIMM attachment procedures. Upon successful group attachment, the group home SwMI will inform the new participating SwMI which attached groups that are linked and who the linking home SwMI is.

All call restoration request should therefore go directly to the linking home SwMI when this information is available. When a migrating user tries to restore a call to a group that it is not attached to, the call restoration request shall be sent to the home SwMI of the group indicated in the U-CALL RESTORE PDU.

NOTE 2: The user who initiated the group call may not be a member of the group.

The group home SwMI when linked to another group or groups shall inform the new participating SwMI to redirect the call restoration request to the linking home SwMI.



#### 4.2.2.3.8 Termination of the group call

Only the controlling TETRA SwMI shall be in control of the termination of the call. When a participating SwMI request for call disconnection, ANF-ISIGC shall route this request over the ISI to the controlling TETRA SwMI CC application. The controlling TETRA SwMI CC application shall validate the call disconnection request and if found valid the controlling TETRA SwMI CC application may choose to either disconnect the entire group call or disconnect the group call partially by only releasing the requesting TETRA SwMI. The reasons to disconnect the call may either be:

- if a participating TETRA SwMI cannot support the call anymore, e.g. because of pre-emption of the resources is necessary or the call length timer of this particular SwMI has expired. The call may then be released partially, i.e. the call continues without the requesting TETRA SwMI;
- if the controlling SwMI fails to support the call anymore. The entire group call across all SwMIs shall be terminated.

NOTE 1: When a participating TETRA SwMI wants to release a call for e.g. pre-emption purposes and to free ISI resources, it cannot acquire access to ISI links which are owned by the controlling TETRA SwMI.

NOTE 2: However, if a TETRA SwMI is used as a transit SwMI, it should be possible for this SwMI to terminate the call if it cannot support the transit function anymore. The capability to do this is linked to the fact that the transit call utilizes switching capacity in the transit SwMI.

When a request to release the group call is received by the controlling SwMI, sent from the call owning user, the controlling SwMI CC application shall always release the entire group call even though the call owning user is located in a participating SwMI. The controlling SwMI shall however still have the possibility of releasing the call even though the call ownership is transferred to a served user in another SwMI.

### 4.2.3 Exceptional procedures

#### 4.2.3.1 Activation/deactivation/registration/interrogation

Not applicable.

#### 4.2.3.2 Invocation and operation

The ANF-ISIGC entity may reject the group call service request from the originating TETRA SwMI with an appropriate failure indication for any of the following reasons:

- if ISI connections are permanently not available;
- if ISI connections are temporary not available;
- if the maximum number of available ISI links have exceeded.

The controlling SwMI may reject the group call service request from the originating TETRA SwMI with an appropriate failure indication for any of the following reasons:

- called group does not support calls from foreign users;
- if the important or critical subscribers of the called group are not available at call set-up time because of unavailability or for other reasons given by the group service profile;
- if a participating TETRA SwMI refuses to participate in the group call due to the call priority which cannot be supported or due to call contention or congestion in the TETRA SwMI.

During the maintenance phase of the call the ANF-ISIGC may reject any signalling request with an appropriate failure indication for any of the following reasons:

- if the ANF-ISIGC cannot grant a higher priority transmission request because it either temporary cannot support interruption or because interruption permanently is not supported;

- if critical ISI connections become either temporary or permanently unavailable due to pre-emption of the resources.

During the maintenance phase of the call the controlling SwMI may reject any signalling request with an appropriate failure indication for any of the following reasons:

- if the important or critical subscribers of the called group have not responded to polling request because of unavailability or for other reasons given by the group service profile;
- if an insufficient number of polling responses have been received;
- if a important or critical SwMI wishes to withdraw from the group call;
- group call cannot be re-established to a migrated user in a SwMI that has not previously been involved in the group call;
- if the important or critical subscribers of the called group suddenly become unavailable.

In addition, all restrictions and exceptional procedures for PSS1 basic call establishment shall apply (see ISO/IEC 11574 [12]), e.g. non-valid destination number in the event that the controlling SwMI could send such a number.

### 4.3 Interaction with other PISN supplementary services and PISN ANFs

There shall be no interactions with other supplementary services and ANFs for which PISN International Standards were available at the time of publication.

### 4.4 Interaction with TETRA supplementary services and other TETRA ANFs

Interactions with other TETRA supplementary services and ANFs for which TETRA Standards or TETRA draft standards were available at the time of publication of the present document are specified below.

#### 4.4.1 Calling Line Identification Presentation (SS-CLIP)

No interaction.

#### 4.4.2 Connected Line Identification Presentation (SS-COLP)

No interaction.

#### 4.4.3 Calling/Connected Line Identification Restriction (SS-CLIR)

No interaction.

#### 4.4.4 Call Report (SS-CR)

No interaction.

NOTE: The originating SwMI will use ANF-ISISS for this service.

#### 4.4.5 Talking Party Identification (SS-TPI)

No interaction.

NOTE: When TPI is invoked for a call, i.e. for a group, the SS-TPI signalling is transported transparently between the controlling SwMI and the participating SwMI(s) and is not considered to be an interaction.

#### 4.4.6 Call Forwarding Unconditional (SS-CFU)

SS-CFU is applicable for group calls if the call is forwarded unconditionally from one group call to another.

ANF-ISIGC shall interact with SS-CFU when a group call is forwarded to a group located in a SwMI other than the called group home SwMI. The call shall be re-routed to the new group home SwMI.

NOTE: SS-CFU can change the service of the call from a group call to an individual call and vice versa.

#### 4.4.7 Call Forwarding on Busy (SS-CFB)

Not applicable.

#### 4.4.8 Call Forwarding on No Reply (SS-CFNRY)

Not applicable.

#### 4.4.9 Call Forwarding on Not Reachable (SS-CFNRC)

Not applicable.

#### 4.4.10 List Search Call (SS-LSC)

No interaction.

#### 4.4.11 Call Authorized by Dispatcher (SS-CAD)

SS-CAD shall interact with ANF-ISIGC when SS-CAD is invoked towards the called group number and the calling user is located in a SwMI other than the restricted groups home SwMI.

#### 4.4.12 Short Number Addressing (SS-SNA)

No interaction.

#### 4.4.13 Area Selection (SS-AS)

SS-AS information shall be forwarded to the group/linking home SwMI. The SwMI shall use this information to set-up the group call and may also be used during call restoration.

NOTE 1: When Area Selection is invoked for a call, i.e. for a group, the SS-AS signalling is transported transparently between the originating SwMI and the controlling SwMI and is not considered to be an interaction.

NOTE 2: The area selection is encoded differently in the ISI protocol than in the air interface and the corresponding information element is named as "selected area number".

#### 4.4.14 Access Priority (SS-AP)

No interaction. SS-AP only applies locally at the radio access.

#### 4.4.15 Priority Call (SS-PC)

If SS-PC has been activated and call set-up operates by queuing, then each call shall be established according to the queuing mechanism implemented in the SwMI(s) for priority calls.

#### 4.4.16 Call Waiting (SS-CW)

No interaction.

#### 4.4.17 Call Hold (SS-HOLD)

No interaction. The ISI-connection shall be maintained during HOLD of an active group call.

NOTE 1: Not applicable when the controlling SwMI has call ownership.

NOTE 2: Group calls that are on HOLD, do not have a call owner.

#### 4.4.18 Call Completion to Busy Subscriber (SS-CCBS)

No interaction.

NOTE: SS-CCBS is only activated when the called group is busy. This can occur when the group call request is made from a user who is not a member of the called group.

#### 4.4.19 Late Entry (SS-LE)

No interaction.

NOTE: When Late Entry is invoked for a call, i.e. for a group, the SS-LE signalling is transported transparently between the controlling SwMI and the participating SwMI(s) and is not considered to be an interaction.

#### 4.4.20 Transfer of Control (SS-ToC)

No interaction.

NOTE 1: When Transfer of Control is invoked for a call, i.e. for a group, the SS-ToC signalling is transported transparently between the participating SwMI(s) and the controlling SwMI and is not considered to be an interaction.

NOTE 2: When a request to release the group call is received by the controlling SwMI, sent from the call owning user i.e. the call owning user is located in the participating SwMI, the controlling SwMI releases always release the entire group call and not allow a partial release. The controlling SwMI however still has the right to releasing the call even though the call ownership is transferred to a served user in another SwMI.

#### 4.4.21 Pre-emptive Priority Call (SS-PPC)

SS-PPC shall interact with ANF-ISIGC to pre-empt an inter-TETRA connection with the lowest Call Retention Value (CRV) among those which may be used to route the priority call. SS-PPC shall invoke pre-emption by forcing the clearing of the chosen inter-TETRA connection and then invoking a new ANF-ISIGC at the corresponding ISI.

NOTE 1: The correct time to tear down the inter-TETRA connections and allocate new inter-TETRA connections, should be when the controlling SwMI has received positive indication back from the participating SwMI that it can and will support the group call (see stage 2).

NOTE 2: If the clearing of an inter-TETRA connection results in the call owning user being released, then the controlling SwMI releases release the complete call.

#### 4.4.22 Include Call (SS-IC)

SS-IC and ANF-ISIGC shall interact whenever the SS-IC served user active in a group call wants to include a user or group of users who are not members of the active group call and who are registered in a SwMI other than the controlling SwMI. The SS-IC shall request the ANF-ISIGC to include the affected user or group of users (user to be included) into the group call.

NOTE: Only the group call owner is allowed to invoke SS-IC for an active group call.

The group call request to each affected user may or may not involve setting up a new inter-TETRA connection to a new participating SwMI previously not part of the group call. In cases where the participating SwMI already contains participating group call members, a set-up message shall be sent using the existing inter-TETRA connection. In cases where the participating SwMI is not already part of the group call a set-up message shall be sent using a new inter-TETRA connection.

#### 4.4.23 Advice of Charge (SS-AoC)

No information available.

#### 4.4.24 Barring of Outgoing Calls (SS-BOC)

No interaction. SS-BOC is operated before ANF-ISIGC invocation.

#### 4.4.25 Barring of Incoming Calls (SS-BIC)

No interaction.

NOTE: SS-BIC is operated in the called group's home SwMI CC application and supplementary service control application.

#### 4.4.26 Discreet Listening (SS-DL)

No interaction.

#### 4.4.27 Ambience Listening (SS-AL)

No interaction.

NOTE: The invocation of the supplementary service SS-AL constitutes a call set-up similar to an individual call.

#### 4.4.28 Dynamic Group Number Assignment (SS-DGNA)

No interaction.

NOTE: When Dynamic Group Number Assignment is invoked for an existing group call, the SS-DGNA signalling is transported transparently between the controlling SwMI and the participating SwMI(s) and is not considered to be an interaction.

#### 4.4.29 Call Completion on No Reply (SS-CCNR)

Not applicable.

#### 4.4.30 Call Retention (SS-CRT)

SS-CRT shall interact with the ANF-ISIGC by having the Call Retention Value (CRV) for the group call assigned to the inter-TETRA connection(s) used to route the call.

#### 4.4.31 Additional Network Features - Inter-System Interface Individual Call (ANF-ISIIC)

The only interactions between ANF-ISIIC and ANF-ISIGC shall be through SS-Include Call and SS Call Forwarding Unconditional (see clauses 4.4.22 and 4.4.6).

NOTE 1: For SS-Include Call, even when all but two group call participants have left a group call, i.e. only the group call owner and the last group call participant are remaining in the call active state, the call remains a group call. This enables easy introduction of new participants into the group call.

NOTE 2: When a group call request is forwarded unconditionally to an individual, ANF-ISIGC invokes ANF-ISIIC and hereafter become IDLE.

#### 4.4.32 ISI Short Data (ANF-ISISD)

No interaction.

#### 4.4.33 ISI Mobility Management (ANF-ISIMM)

No interaction.

NOTE: All updating of the SwMI databases used for the operation of ANF-ISIGC are not to be considered as interactions between ANF-ISIMM and ANF-ISIGC.

### 4.5 Interworking considerations

ANF-ISIGC and Public Switched Telephone Network (PSTN) shall interwork in the case of a PSTN call through a TETRA gateway located in a SwMI different from that where the TETRA called group has its home SwMI.

For an incoming telephony call to a TETRA group, the PSTN calling user shall have to send the number of the called group to the TETRA PSTN gateway. If the call is a group call and the SwMI where the gateway is located is not the called group's home SwMI, an ANF-ISIGC entity shall be invoked to extend the group call requested to the called group's home SwMI. This ANF-ISIGC entity shall use the GTSI number, converted from the received PSTN number, as the called number.

NOTE 1: A PSTN telephone call may result in a TETRA speech (tele-) service call.

NOTE 2: Only the calling user can participate in a group call to a group which it is not a member of. Therefore, a group call made by a TETRA user cannot involve an individual from an external network.

A similar procedure shall apply for an incoming data call, with the difference that this call would first be connected by the gateway to some modem belonging to its modem pool.

NOTE 3: For data calls from PSTN, TETRA bearer service negotiation may be possible with the called SwMI or the group home SwMI. However, this is only possible if the called SwMI can inform the gateway modem which bearer service it supports sufficiently fast. Otherwise, the negotiation phase between the two modems involved in the call establishment, one on the calling party side and the other from the PSTN gateway modem pool, may be over.

ANF-ISIGC and Integrated Services Digital Network (ISDN) shall interwork in the case of an ISDN call through a TETRA gateway located in a SwMI different from that where the TETRA called group has its home SwMI.

For an incoming call to a TETRA group, contrary to the case of a PSTN calling user, the ISDN calling user can send the identity of the called group to the TETRA ISDN gateway. It shall do this by using one of the various means available (e.g. using the ISDN supplementary services subaddressing or user to user signalling) for ISDN. The calling user can also indicate the type of call, telephony or data call, through the bearer service requested.

NOTE 4: An ISDN telephony teleservice may result in a TETRA speech (tele-) service call. And an incoming ISDN call requesting a bearer capability defined by an information transfer capability value equal to unrestricted digital information, and a layer 1 access protocol value corresponding to the rate adaptation in accordance with ITU-T Recommendation V.110 [i.7], may result in a TETRA data call.

The data rate for the call might then be negotiated using the (optional) In-band Parameter Exchange (IPE) procedure described in appendix I of this ITU-T Recommendation V.110 [i.7].

ANF-ISIGC and PISN shall interwork in the case of a PISN call through a TETRA gateway located in a SwMI different from that where the TETRA called group has its home SwMI. This interworking shall be exactly the same as that described above between ANF-ISIGC and ISDN, in replacing ISDN number by PISN number.

NOTE 5: The fact that ANF-ISIGC allows the use of PISN to interconnect the SwMIs involved in inter-TETRA group calls is not to be considered as interworking at stage 1 level.

## 4.6 Static description of ANF- ISIGC using attributes

In accordance with ITU-T Recommendation I.210 [i.4], the static description of ANF-ISIGC is given below using the relevant attributes with the corresponding values as defined in ITU-T Recommendation I.140 [i.3].

ANF-ISIGC is extending over the ISI the TETRA bearer or tele- service invoked by a group calling user, by creating the necessary connection between the originating, the controlling and the participating SwMIs. The corresponding bearer service attributes are given in annex C, which is informative (since it is simply reformulating the corresponding information defined in EN 300 392-2 [3]).

Using the terminology defined in ITU-T Recommendation I.140 [i.3], the connection to be created by ANF-ISIGC as a result of its invocation and operation is a connection element.

Table 1 defines the static description of this connection element in terms of the values of its attributes as listed in ITU-T Recommendation I.140 [i.3].

NOTE 1: The attributes in table 1 have been grouped into categories in a similar manner as in ITU-T Recommendation I.210 [i.4] for the bearer service attributes.

As already stated in clause 4.2.2.3, call modification shall have no impact on the connection(s) established by the invoked ANF-ISIGC, but it shall result in a change of the encoding of the user information when the data rate of this information changes. Thus, the access attribute Information transfer coding/protocol in the static descriptions of the ISI connection elements in table 1 may change when a call modification occurs. No other attribute in these tables shall change.

NOTE 2: As to the case of 64 kbit/s connection elements, addressed in table 1, obviously there is no possibility to change the information transfer rate of these connection elements.

**Table 1: Basic definition of ANF-ISIGC connection element attributes**

Attribute category	Attribute name	Attribute value
Information transfer attributes	1. Information transfer mode: 2. Information transfer rate: 3. Information transfer capability: 4. Structure: 5. Establishment of connection: 6. Symmetry: 7. Connection configuration:	circuit 64 kbit/s no restriction (see note) unstructured demand bi-directional symmetric point-to-point
Access attributes	8. Channel: 9. Connection control protocol: 10. Information transfer coding/ protocol	$B_Q$ for user information, $D_Q$ for signalling PSS1 for $D_Q$ -channel packet mode, refer to TS 100 392-3-8 [i.1]
General attributes	11. Network performance 12. Network interworking 13. Operations and management aspects	for further study for further study for further study
NOTE:	According to the definition of the attribute information transfer capability of a connection element in ITU-T Recommendation I.140 [i.3], the value of this attribute for the ANF-ISIGC connection element should be "null". Since this value means that there is no restriction to the types of information which may pass through the connection element, the term "no restriction" has been preferred.	

**Table 2: Void**

## 4.7 Overall SDL

Figures 3 to 17 contain the dynamic description of ANF-ISIGC using the Specification and Description Language (SDL) defined in ITU-T Recommendation Z.100 [i.5]. The SDL process represents the behaviour of the set of SwMI entities involved, interconnected by the intervening network, possibly by a PISN, in providing ANF-ISIGC.

The following conventions are used:

- the input signals from the left and output signals to the left represent primitives from and to the initiating or controlling SwMI CC application;
- the input signals from the right and output signals to the right represent primitives from and to the served SwMI CC application.



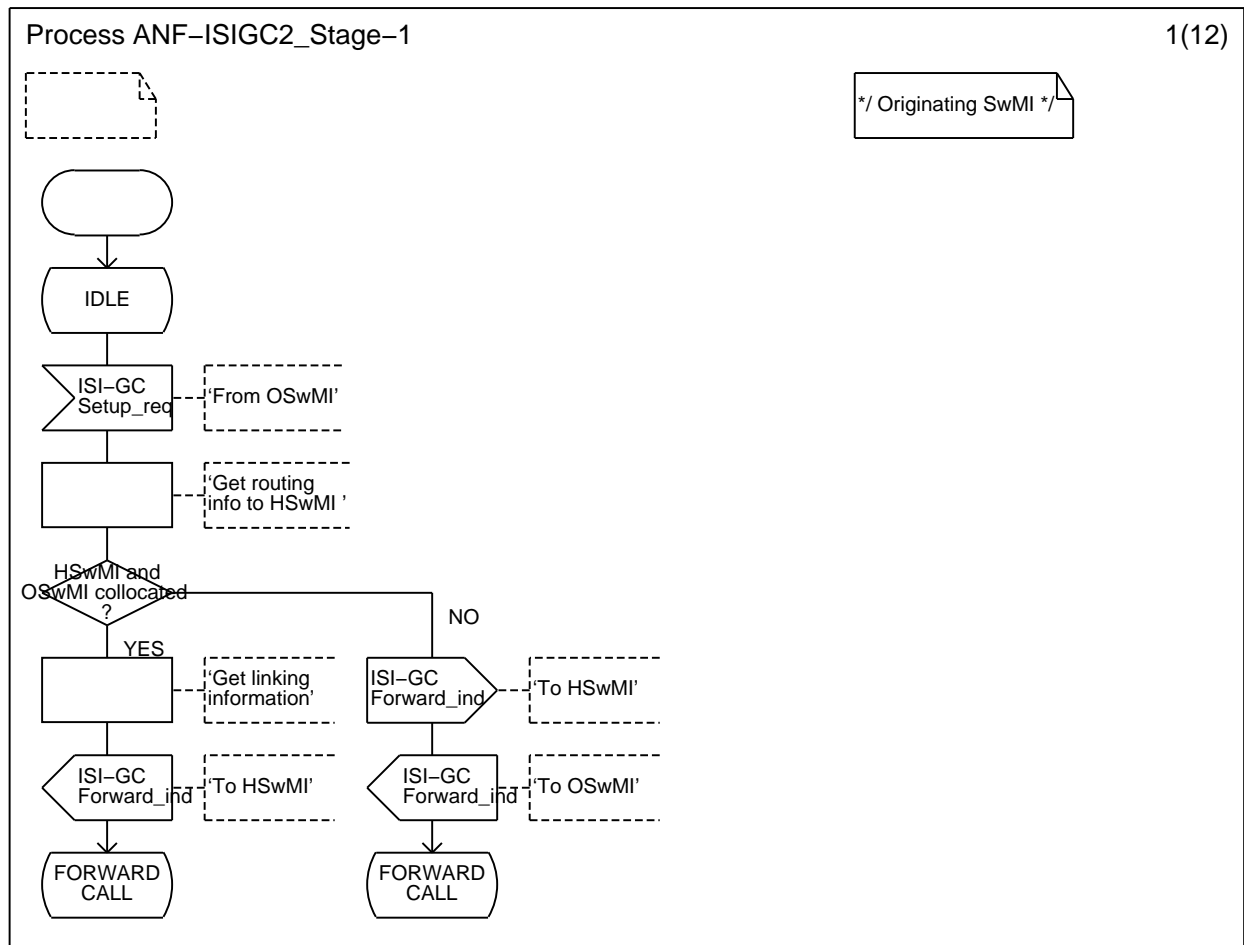


Figure 3: ANF-ISIGC, over all SDL (sheet 1 of 15)

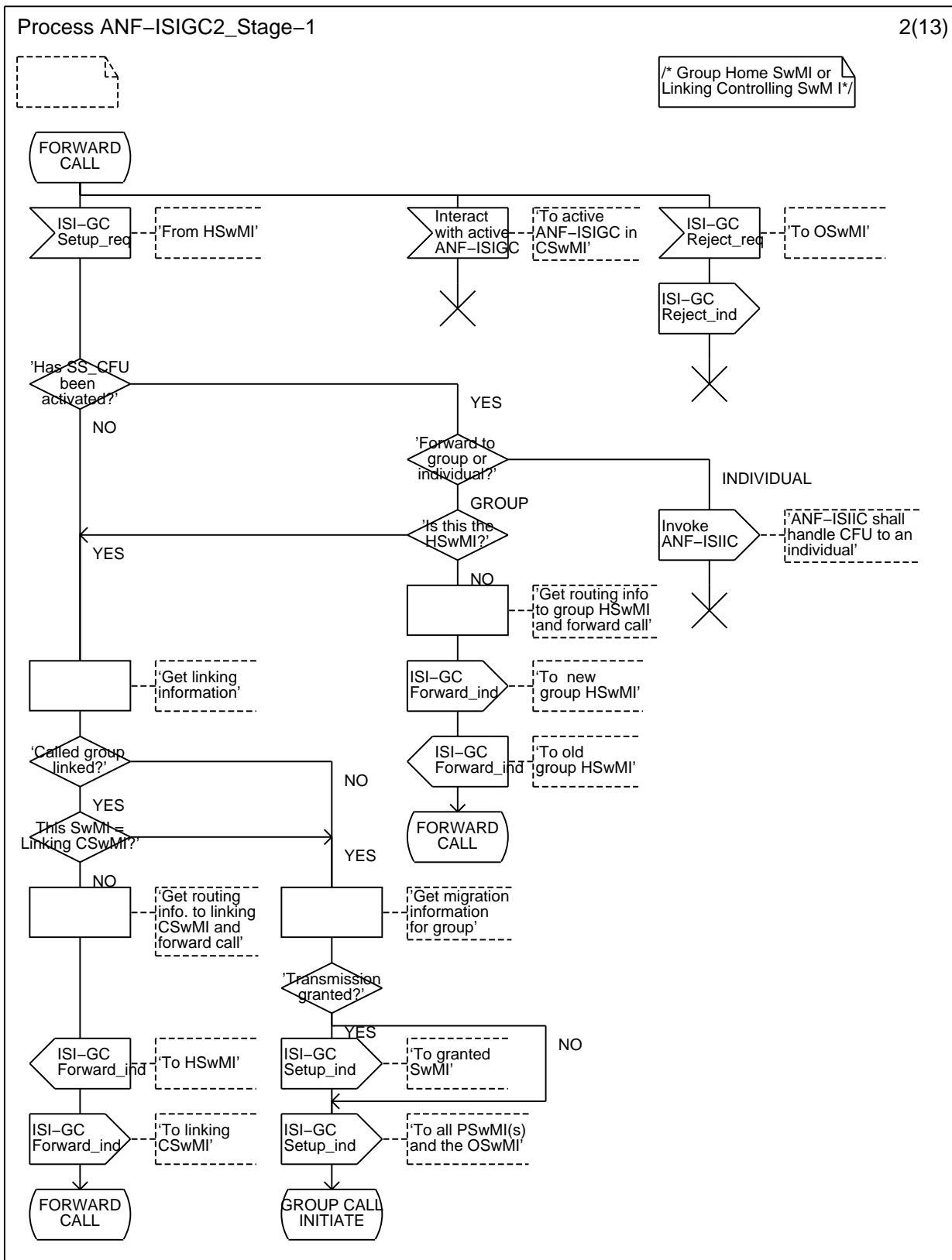


Figure 4: ANF-ISIGC, over all SDL (sheet 2 of 15)

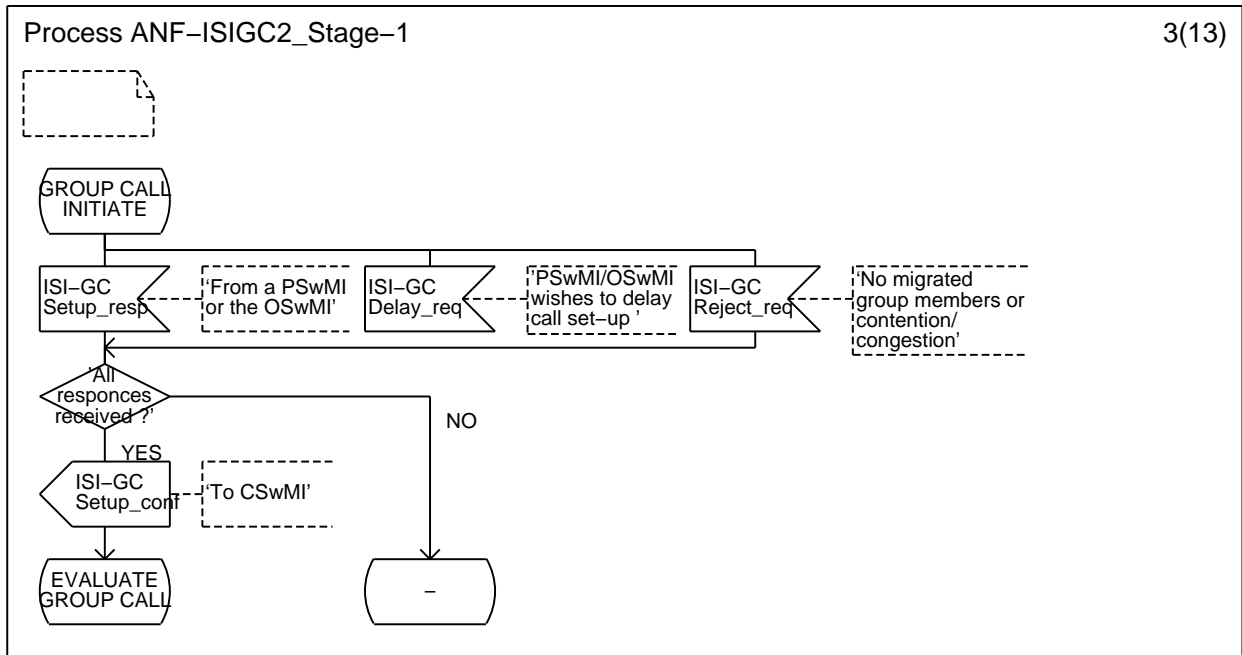


Figure 5: ANF-ISIGC, over all SDL (sheet 3 of 15)

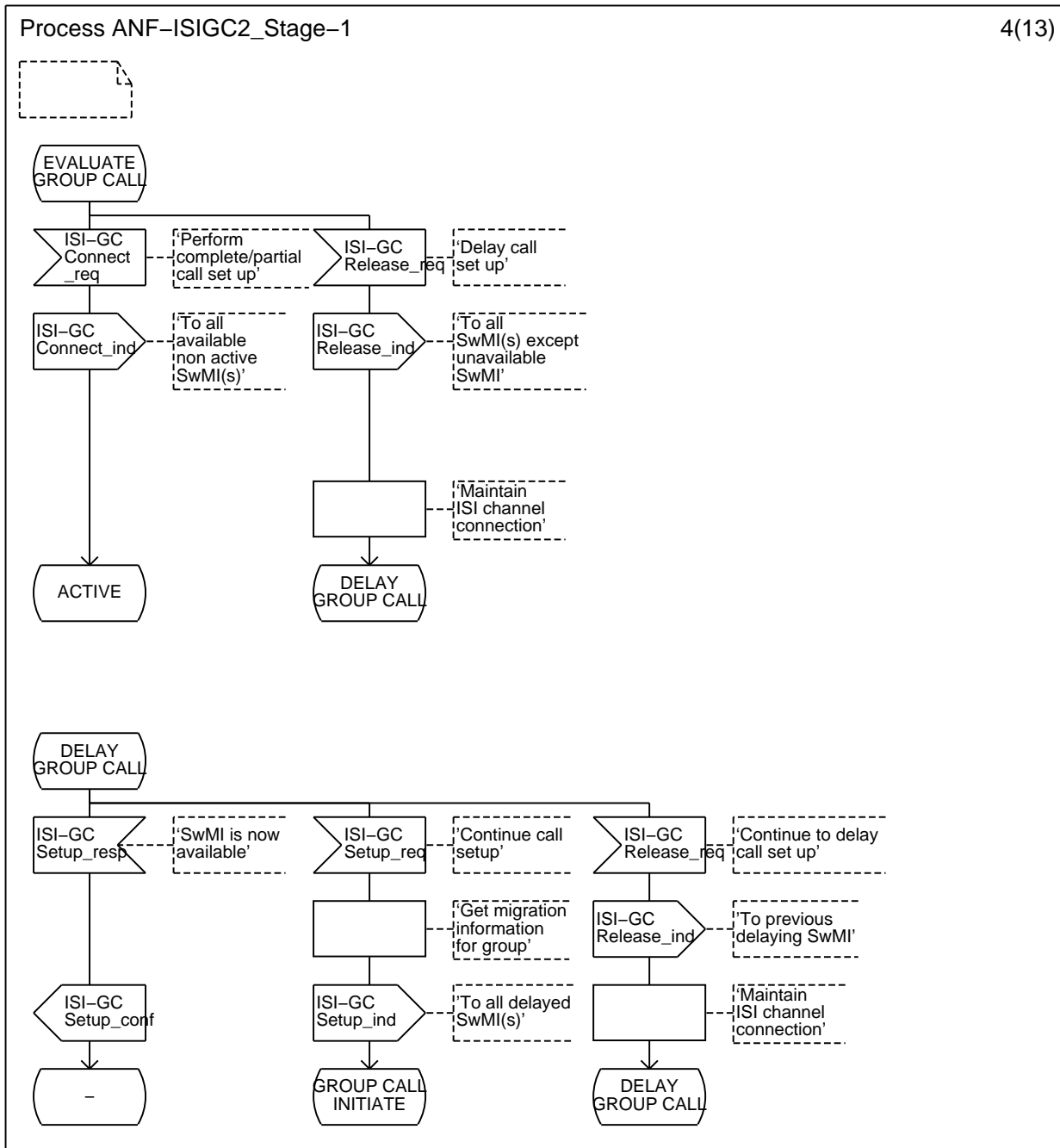


Figure 6: ANF-ISIGC, over all SDL (sheet 4 of 15)

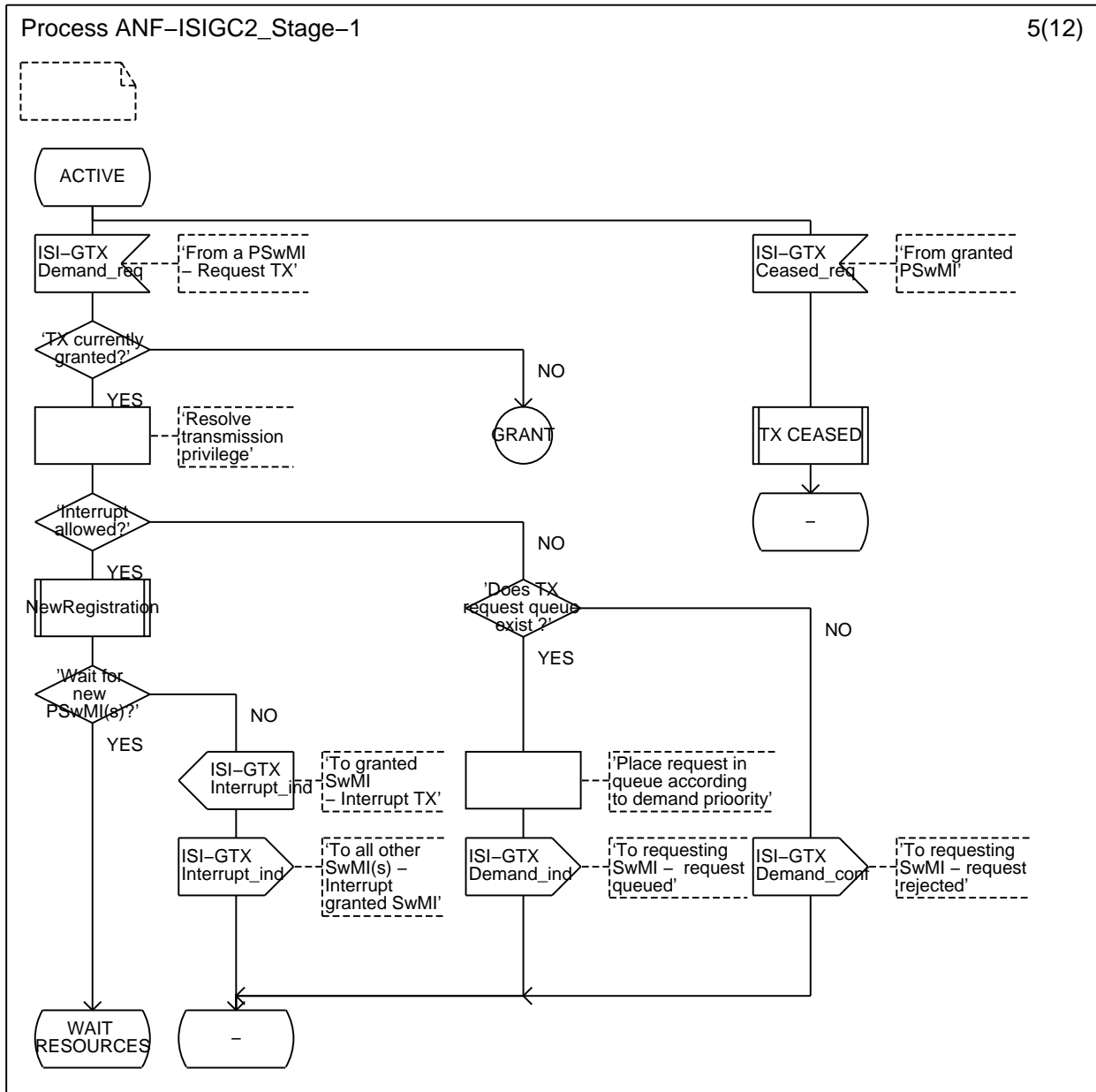


Figure 7: ANF-ISIGC, over all SDL (sheet 5 of 15)

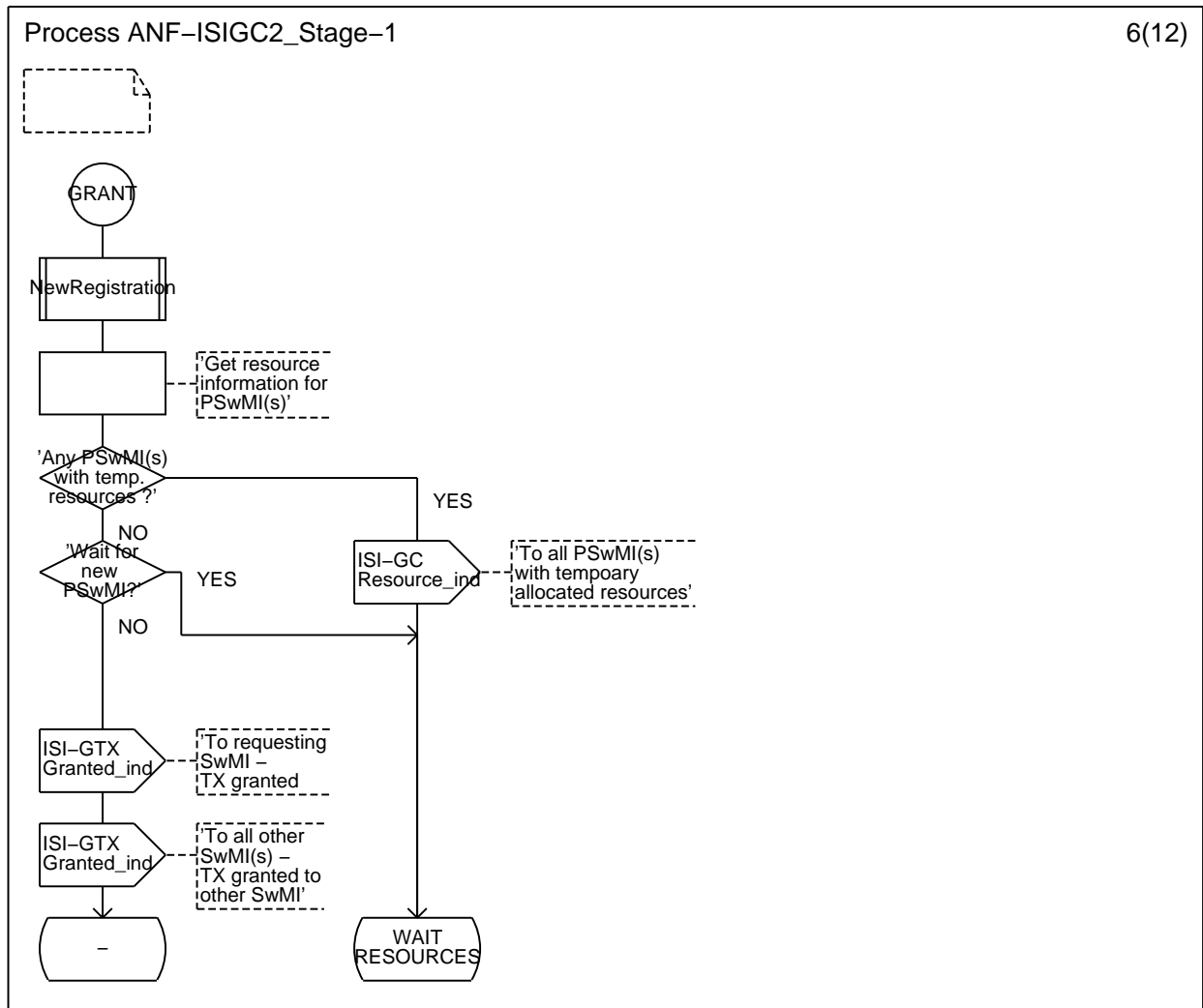


Figure 8: ANF-ISIGC, over all SDL (sheet 6 of 15)

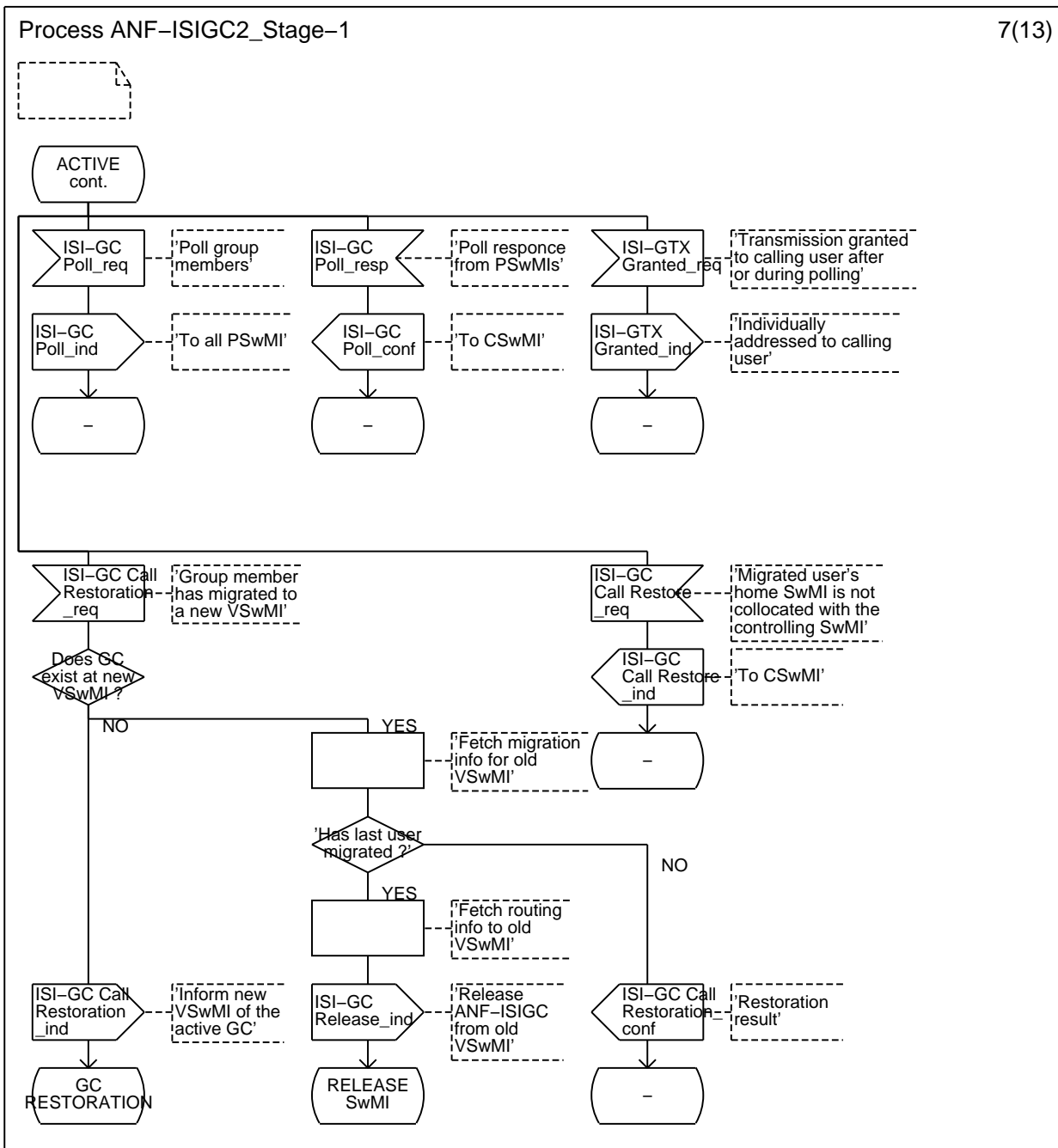


Figure 9: ANF-ISIGC, over all SDL (sheet 7 of 15)

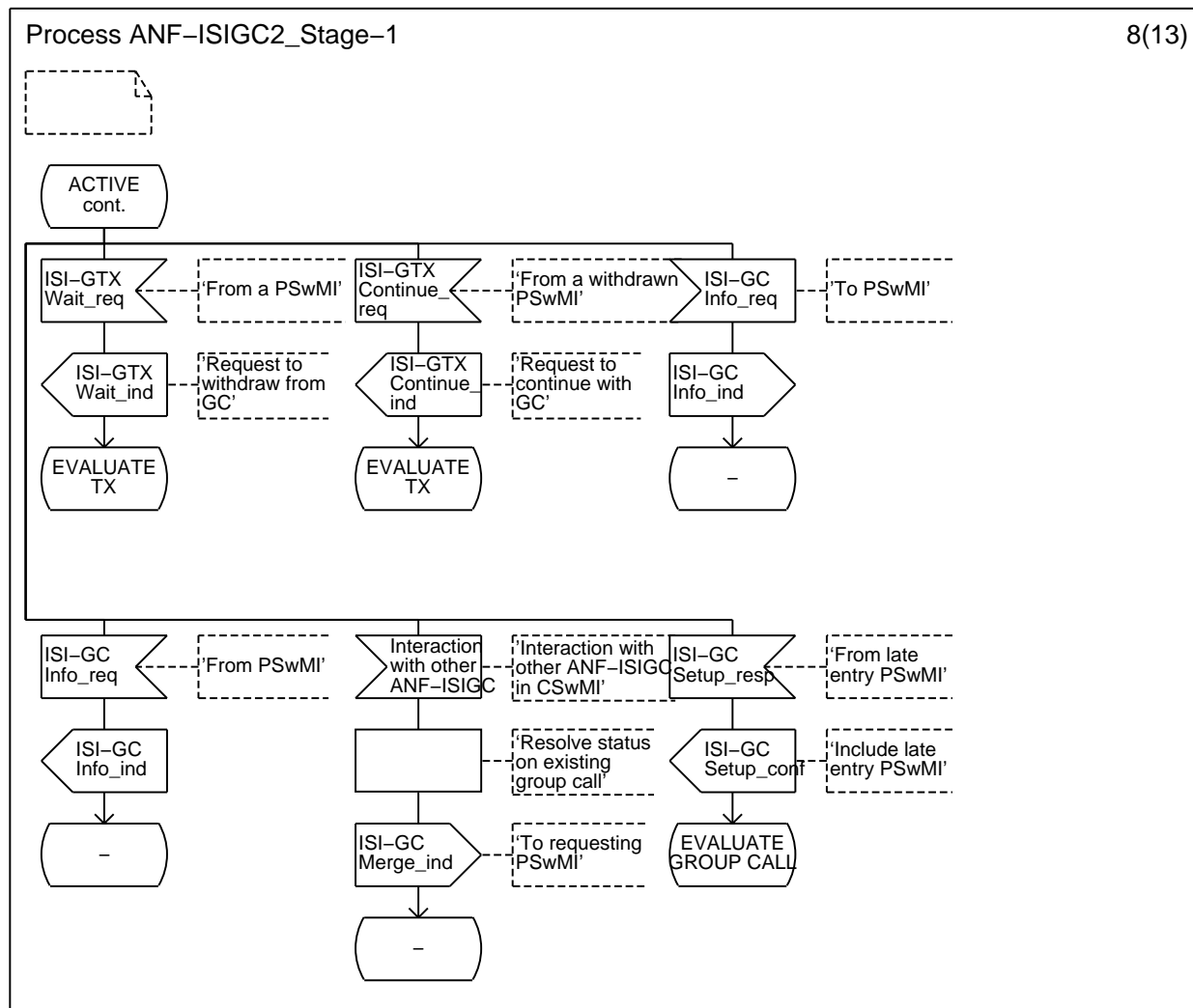


Figure 10: ANF-ISIGC, over all SDL (sheet 8 of 15)

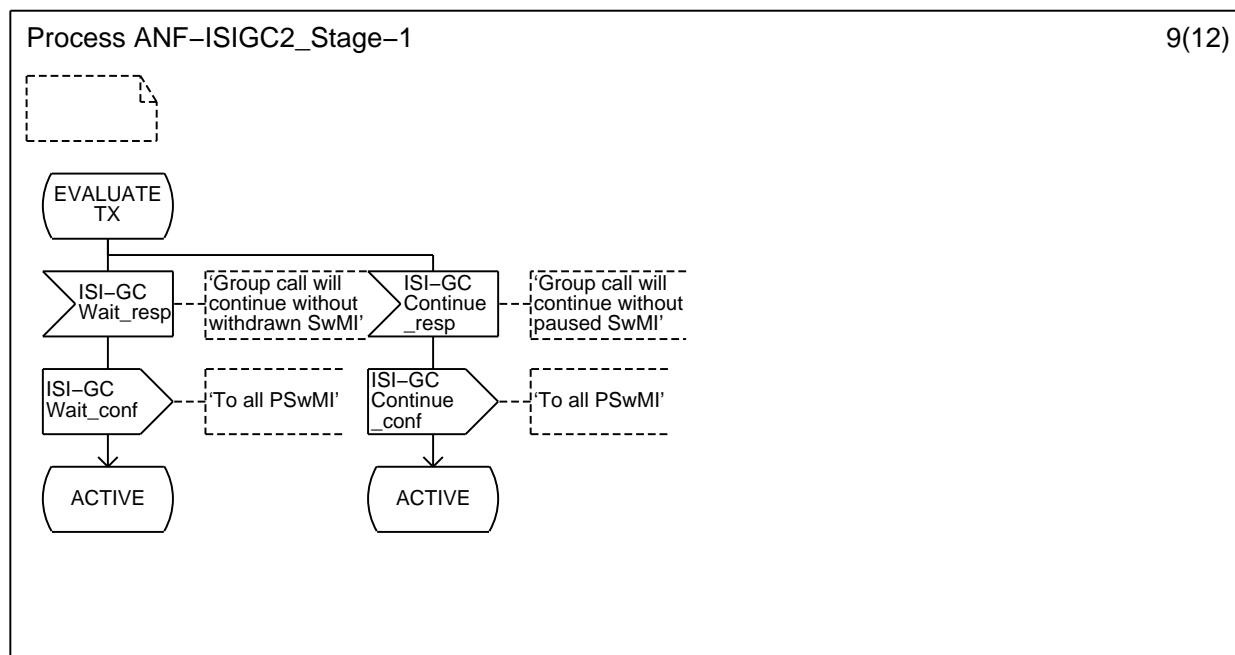


Figure 11: ANF-ISIGC, over all SDL (sheet 9 of 15)



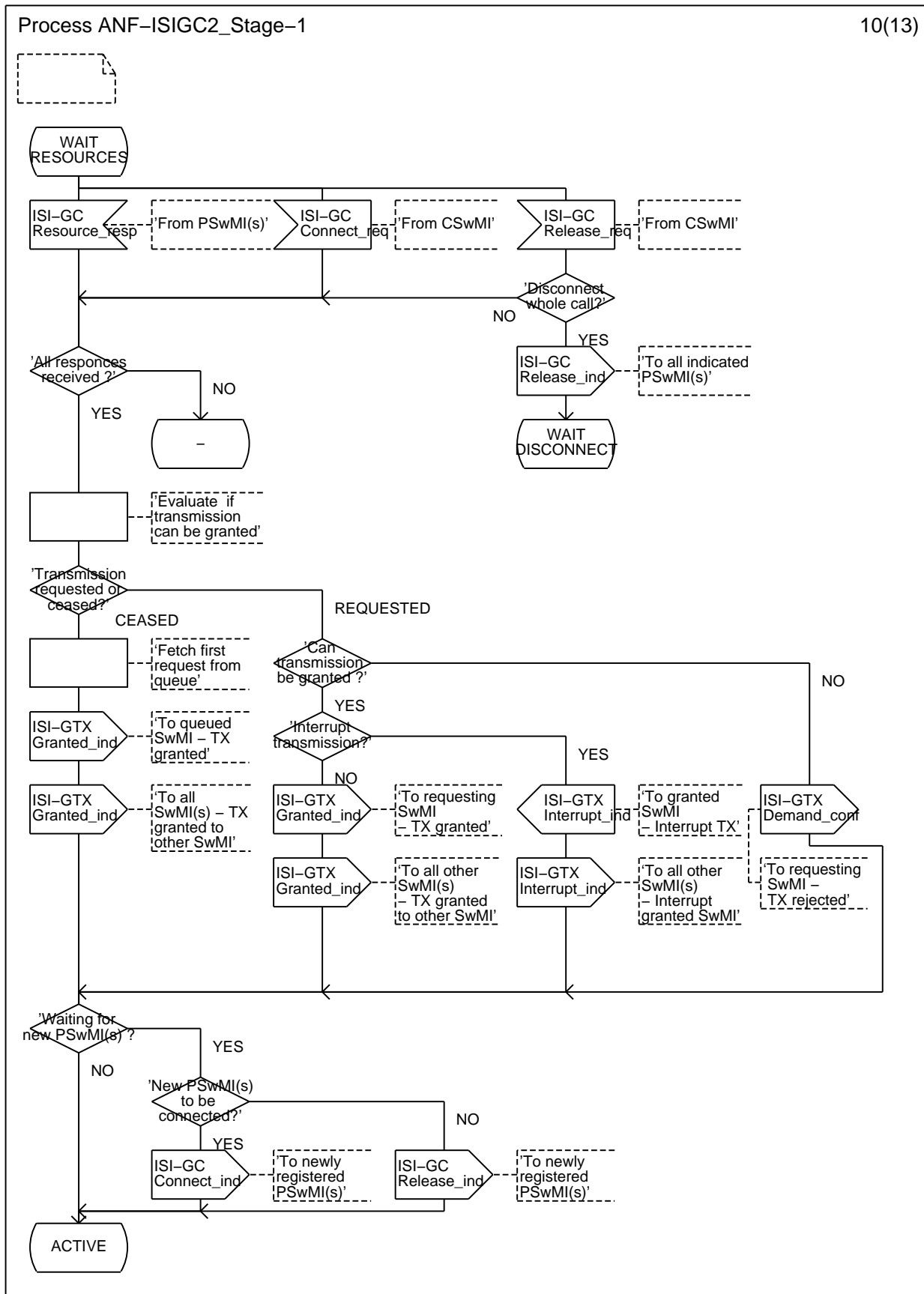


Figure 12: ANF-ISIGC, over all SDL (sheet 10 of 15)

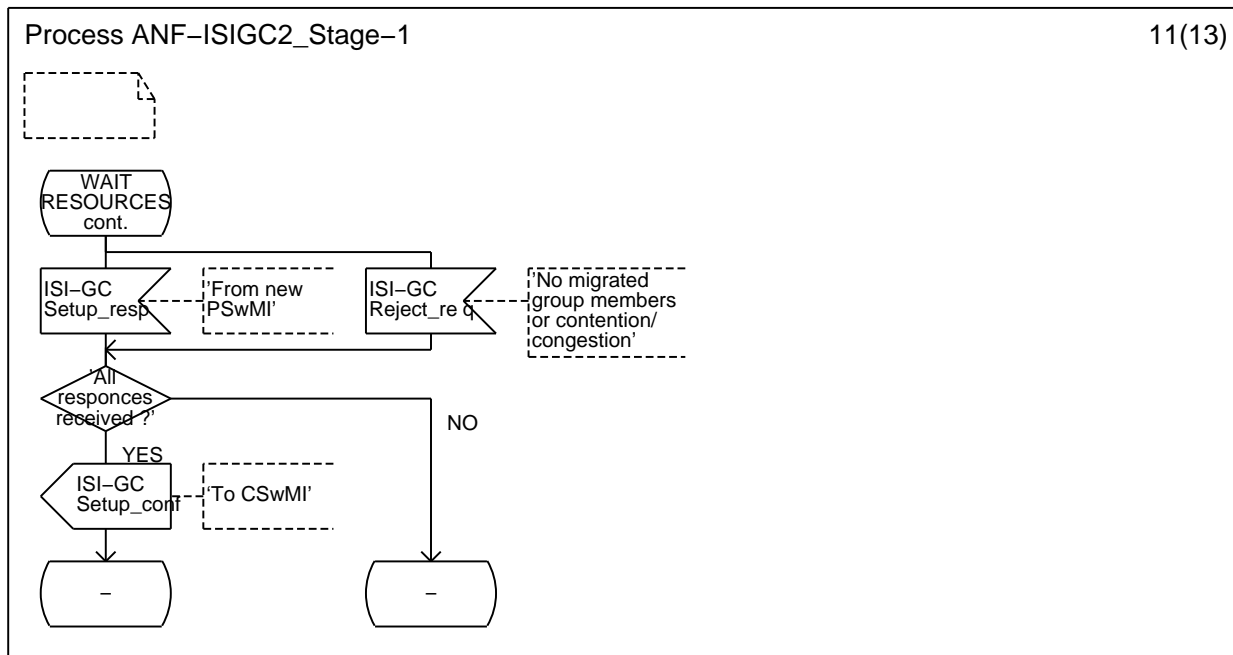


Figure 13: ANF-ISIGC, over all SDL (sheet 11 of 15)

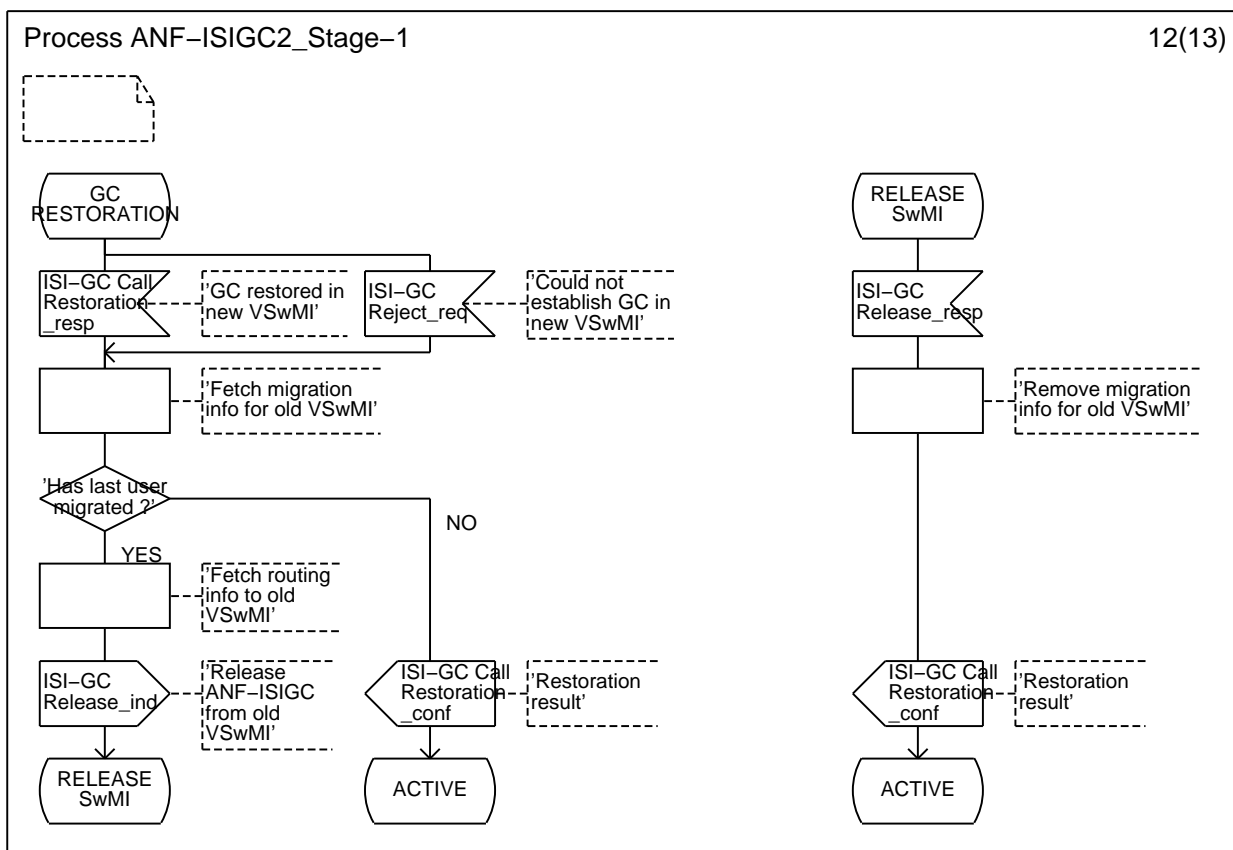


Figure 14: ANF-ISIGC, over all SDL (sheet 12 of 15)

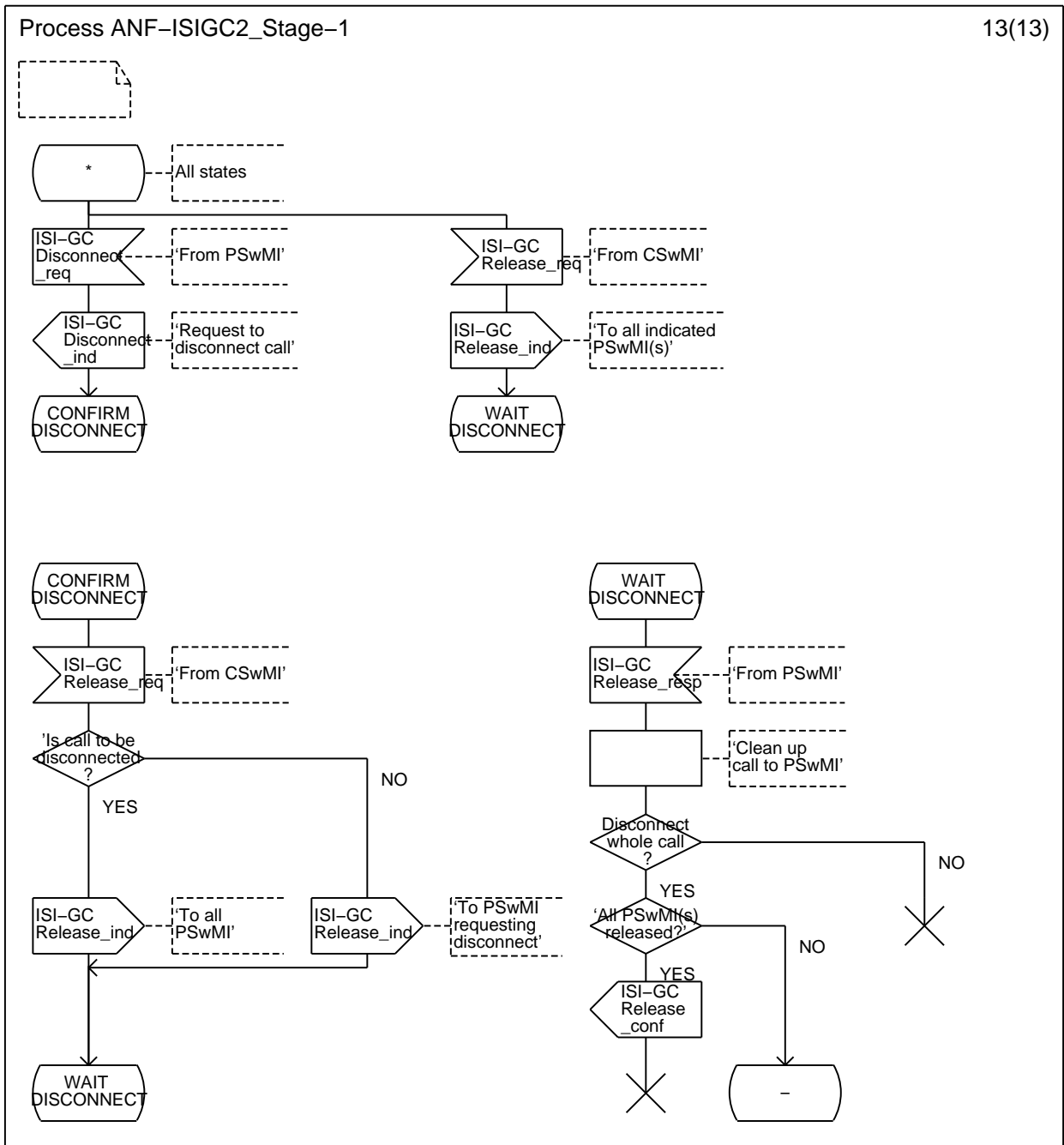


Figure 15: ANF-ISIGC, over all SDL (sheet 13 of 15)

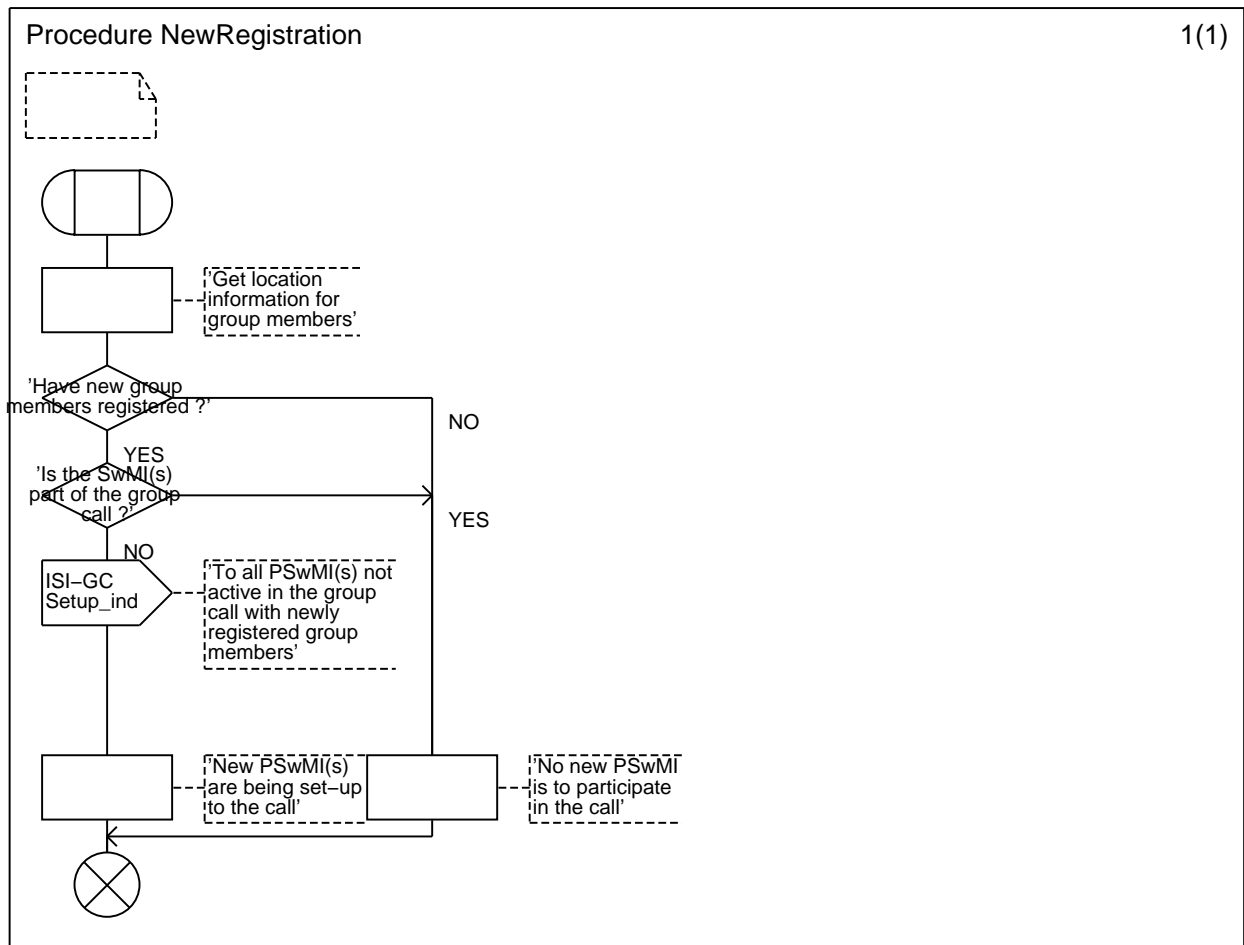


Figure 16: ANF-ISIGC, over all SDL (sheet 14 of 15)

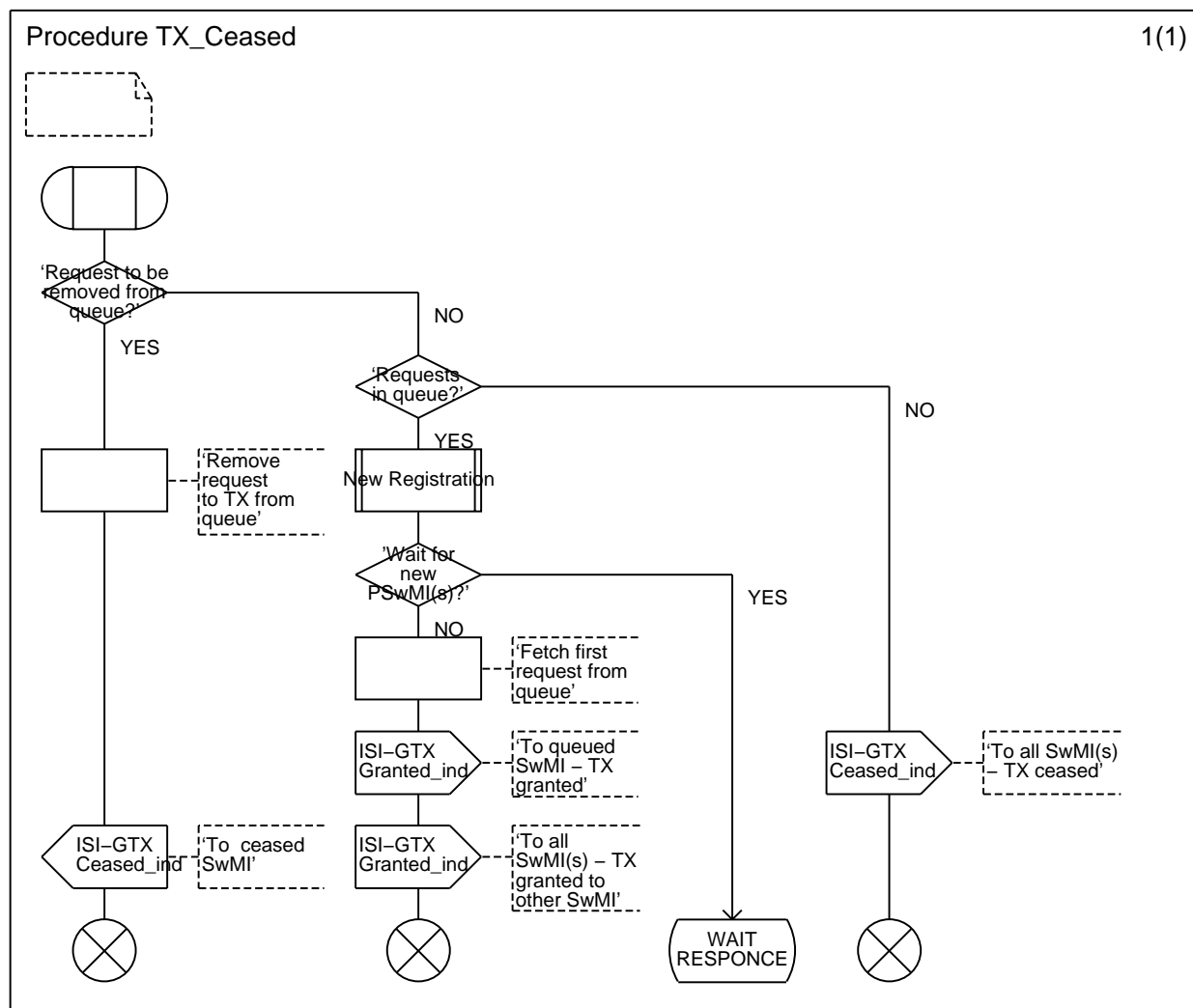


Figure 17: ANF-ISIGC, over all SDL (sheet 15 of 15)

## 5 ANF-ISIGC stage 2 specification

### 5.1 Functional model

#### 5.1.1 Functional model description

The functional model shall comprise the following functional entities:

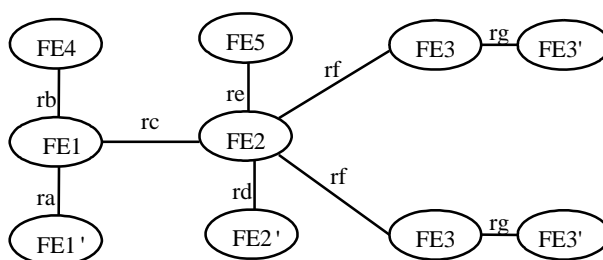
- FE1 ISI group call originating entity.
- FE1' Originating SwMI call control application functional entity.
- FE2 ISI group home controlling entity/group call controlling entity.
- FE2' Group home SwMI/Controlling SwMI call control application functional entity.
- FE3 ISI group call participating entity.
- FE3' Participating SwMI call control application functional entity.
- FE4 ISI Database entity of the calling party (ITSI).

FE5 ISI Database entity of the called group (GTSI).

The following functional relationships shall exist between these FEs:

- ra between FE1' and FE1.
- rb between FE1 and FE4.
- rc between FE1 and FE2.
- rd between FE2 and FE2'.
- re between FE2 and FE5.
- rf between FE2 and FE3.
- rg between FE3 and FE3'.

Figure 18 shows the FEs and their relationships.



**Figure 18: Functional model for the ANF-ISIGC**

## 5.1.2 Description of functional entities

### 5.1.2.1 ISI group call originating entity, FE1

FE1 represents the originating entity of the group call. The purpose of this FE shall be to receive an outgoing group call request from the originating SwMI CC and forward the call request and call control to FE2.

This functional entity shall:

- detect an outgoing group call;
- request and receive information on the individual identity (ITSI) from FE4;
- determine routeing to FE2;
- forward the call set-up request to FE2;
- re-route the call set-up request to a linking controlling SwMI or a new group home SwMI (when SS-CFU has been invoked);
- receive a set-up indication from FE2 for the initiated group call;
- receive the response on the delivered group call request from FE1' and forward the response to FE2;
- connect the calling user and invoke FE3 upon reception of a group call connect request;
- release the group call on request from FE2;
- receive request for group call release from FE1' and forward the request to FE2;
- function as an intermediary between TETRA and PSS1 call control.

### 5.1.2.2 Originating SwMI CC application functional entity, FE1'

FE1' represents the CC application entity of the originating SwMI. This FE represents the existing call control functionality for a single SwMI. The purpose of this FE is to initiate the establishment of a group call when a set-up information flow is received from a calling user (at the air interface). FE1' should invoke FE1 when establishment of the call is to a group which, to FE1's knowledge, is registered in another TETRA network.

This functional entity may:

- detect an ISI outgoing group call at the air interface;
- analyse the calling MS's profiles;
- analyse the called group number;
- invoke FE1 and forward the call set-up request;
- analyse set-up indication received by FE1 for the initiated group call;
- analyse resource availability and reserve resources;
- co-ordinate call identity with FE3';
- release the group call when requested by FE1;
- request to disconnect group call.

NOTE: FE1' is not part of the ISI standard.

### 5.1.2.3 ISI group call controlling entity, FE2

FE2 can represent either the group home entity or the controlling entity of the group call. After call set-up, FE2 shall always represent the controlling entity. The group home entity will only differ from the controlling entity when the called group is linked to a group located in another SwMI, and this other SwMI is the linking controlling SwMI.

FE2 shall be the central distribution and reception point for all group call signalling between FE3s, FE1 and FE2'. During the maintenance phase of the call, FE2 shall control all transmission granting.

This functional entity shall:

- receive forwarded group call request from FE1;
- receive and request information on the group identity (GTSI) from FE5;
- perform additional analyse of the called group number;
- re-route the call when this SwMI is not the controlling SwMI or when the group call has been forwarded unconditionally;
- determine routing over ISI trunks to participating SwMIs;
- send call set-up to all FE3s and FE1 participating in the group call;
- perform transmission control during call maintenance phase;
- releases the ISI group call path when the last migrated user in a participating SwMI migrates to a new participating SwMI;
- forward disconnect call request received from FE3 to FE2';
- clear the call to participating SwMI (FE3) when requested by FE2';
- function as an intermediary between TETRA and PSS1 call control.

#### 5.1.2.4 Controlling SwMI CC application functional entity, FE2'

FE2' represents the CC application entity of the group home SwMI or controlling SwMI. After call set-up, FE2' shall always represent the controlling SwMI CC application entity. The group home CC application entity will only differ from the controlling SwMI CC application entity when the called group is linked to a group located in another SwMI, and this other SwMI is the linking controlling SwMI.

FE2' represents the existing call control functionality for a single SwMI. This FE shall be the central point for all group call arbitration between FE3s, during call set-up and release.

This functional entity may:

- analyse incoming group call request from FE2;
- perform analyse of the called group profiles;
- analyse the call set-up response from all participating FE3s and FE1;
- initialize polling of all participating FE3s in the case of acknowledged group call;
- initialize call set-up delays in the case of delay request;
- forward call restoration information to FE2;
- analyse withdraw and continue request from FE3;
- analyse call disconnection request from FE2.

NOTE: FE2' is not part of the ISI standard.

#### 5.1.2.5 ISI group call participating entity, FE3

FE3 represents the participating entity of the group call. This FE shall be an intermediary between FE2 and the participating SwMI CC application, FE3'. The participating SwMI may have one or more members of the group call registered either as resident or as visitor. If the called group is linked to a group or groups and the linking controlling SwMI is different from the called group's home SwMI, then residents (members of the linked group) can exist in a participating SwMI.

This functional entity shall:

- receive an incoming ISI group call from FE2;
- receive the response on the delivered group call request from the FE3' and forward the response to FE2;
- receive a polling request from FE2 and inform FE3' to poll group members;
- receive call information from FE2 and forward to FE3' or from FE3' and forward to FE2;
- receive continuation and withdrawal information from FE3';
- receive transmission control information from FE2 and deliver it to FE3';
- receive request for transmission from FE3' and forward the request to FE2;
- release the group call on request from FE2;
- receive request for group call release from FE3' and forward the request to FE2;
- function as an intermediary between TETRA and PSS1 call control.



### 5.1.2.6 Participating SwMI CC application functional entity, FE3'

FE3' represents the CC application entity of the participating SwMI. This FE represents the existing call control functionality for a single SwMI. The purpose of this FE is to analyse group call set-up request from FE3 and forward these request to the called users (over the air interface).

This functional entity may:

- analyse group call set-up request received by FE3;
- perform analyse on the called group number;
- analyse resource availability and reserve resources;
- poll group members over the air interface;
- request to withdraw from group call;
- request to continue with group call;
- forward transmission request and ceases from users;
- release the group call when requested by FE1;
- request to disconnect group call.

NOTE: FE3' is not part of the ISI standard.

### 5.1.2.7 ISI Calling MS Database entity (ITSI), FE4

FE4 represents the Database entity of the calling MS for a group call request. This FE shall provide the basic and supplementary user profiles of the calling MS to the requesting entity. The user profiles contain information about the available services for the individual MS, e.g. whether the MS may initiate a group call or not, or whether there may exist interactions to other services for the MS. The interrogation with the Database may either be with the Visitor Data Base (VDB) or it may be with the IHDB depending on which SwMI the calling MS is located in.

This functional entity shall:

- provide individual user profile information to the functional entity were FE4 is located;
- check whether any interrogation exist between the invoked service and other services, e.g. supplementary services, for the calling MS and provide the information to the functional entity were FE4 is located.

### 5.1.2.8 ISI Called Group Database entity (GTSI), FE5

FE5 represents the Database entity of the called group for a group call request. The purpose of this FE shall be to provide the basic and supplementary group profiles of the called group to the requesting entity. The group profiles contain information about the properties for the called group, e.g. who are the important users of the group, or what is the priority of the group, or whether there may exist interactions to other services for the group. The interrogation with the Database shall be with the GHDB. The interrogation shall also include any relationships between the calling MS and the called group.

This functional entity shall:

- provide group (GTSI) profile information to the functional entity were FE5 is located;
- check whether any interrogation exist between the invoked service and other services, e.g. supplementary services, for the called group and provide the information to the functional entity were FE5 is located.

### 5.1.3 Relationship of functional model to PSS1 basic call functional model

By definition, an invoked ANF-ISIGC establishes a PISN basic call. As a result its functional model matches closely that of PISN basic call (as defined in ISO/IEC 11572 [11]). For established group calls:

- FE2 shall be collocated with the originating PISN CC;
- FE3(s) shall be collocated with a terminating PISN CC.

Figure 19 shows an example of the relationship between the two models:

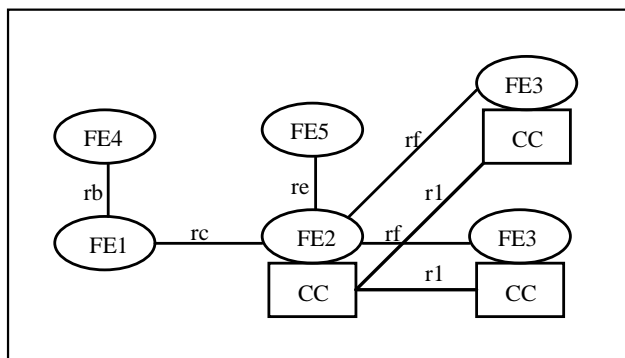


Figure 19: Example relationship between models for ANF-ISIGC and PSS1 basic call

## 5.2 Information flow

### 5.2.1 Information flow diagrams

This clause specifies the information flow scenarios for the ANF-ISIGC basic operation services. The information flow scenarios shall provide sequences arising from error situations, interactions with PSS1 basic call, interactions with other PSS1 supplementary services, interactions with other TETRA ANFs and TETRA supplementary services, different topologies, etc.

NOTE 1: The information flow scenarios in stage 2 do not cover all possible signalling scenarios.

The stage 3 description of ANF-ISIGC shall provide signalling procedures in support of the information flow sequences specified below.

In the information flow scenarios, ANF-ISIGC information flows are represented by solid arrows where the flow is given by the name above the flow, and PSS1 basic call information flows are represented by flow names in square brackets below the flow. Whenever the PSS1 flow name is given, the two information flows occur simultaneously. Within a column representing an ANF-ISIGC functional entity, the numbers refer to functional entity actions listed in clause 5.3.

NOTE 2: The names used for the PISN basic call information flows are those defined in ISO/IEC 11572 [11] and ISO/IEC 11582 [13], description of PISN basic call. Whenever possible (i.e. when such primitives exist), the names given to the ANF-ISIGC information flows are those of the corresponding CMCE uplink and downlink PDUs, as defined in clause 14.7 of EN 300 392-2 [3].

The following abbreviations are used:

- |      |               |
|------|---------------|
| req  | request.      |
| ind  | indication.   |
| resp | response.     |
| conf | confirmation. |

### 5.2.1.1 Successful group call set-up over ISI using ANF-ISIGC

Figures 20 through 30 show the information flow sequence for a successful group call set-up using ANF-ISIGC. The figures cover all three cases described in clause 4.2.2.3.1 plus the case where the called group is linked to another group in a SwMI other than its own home SwMI, this shall be case 4.

For the **case 1 scenario** the originating FE1 and the controlling FE2 are collocated. Figures 20 to 22 show how group members located in visited SwMIs (FE3s) are called using the group identity (GTSI). The group identity belongs to the group home SwMI.

For the **case 2 scenario** the originating FE1 is located in a visited SwMI where a visited MS is calling its home group ID (GTSI). Figures 23 to 26 show the information flow sequence when the group call request is forwarded to the controlling FE2 in the group home using ANF-ISIGC.

For the **case 3 scenario** the originating FE1 can be located in either the visited or in the home SwMI of the calling MS. The controlling FE2 is located in the called group home SwMI. Figures 23 to 26 show the information flow sequence when an MS initiates a group call to a foreign group over the ISI using ANF-ISIGC.

For the **case 4 scenario** the originating FE1 and the controlling FE2 are collocated. Figures 27 to 30 show the information flow sequence for a group call to a linked group over the ISI using ANF-ISIGC. The MS is calling a group ID in its own network. The called group ID is linked to a group ID in another SwMI, where the other SwMI is the group home SwMI of the linked group. There may be other case 4 scenarios which however also are subsets of case 2 scenarios and case 3 scenarios. These are:

- 1) The MS is not in its home and calls a group ID which the MS is not member of. The group ID is associated to a group ID in another network.
- 2) The MS is in its home and calls a group ID which the MS is not member of. The group ID is associated to a group ID in another network.
- 3) The MS is not in its home and calls a group ID which has been given to the MS as a VGSSI. There also exists an association between the VGSSI and the original group ID in the home SwMI of the MS. The VGSSI may or may not have ordinary group members in the migrated network.

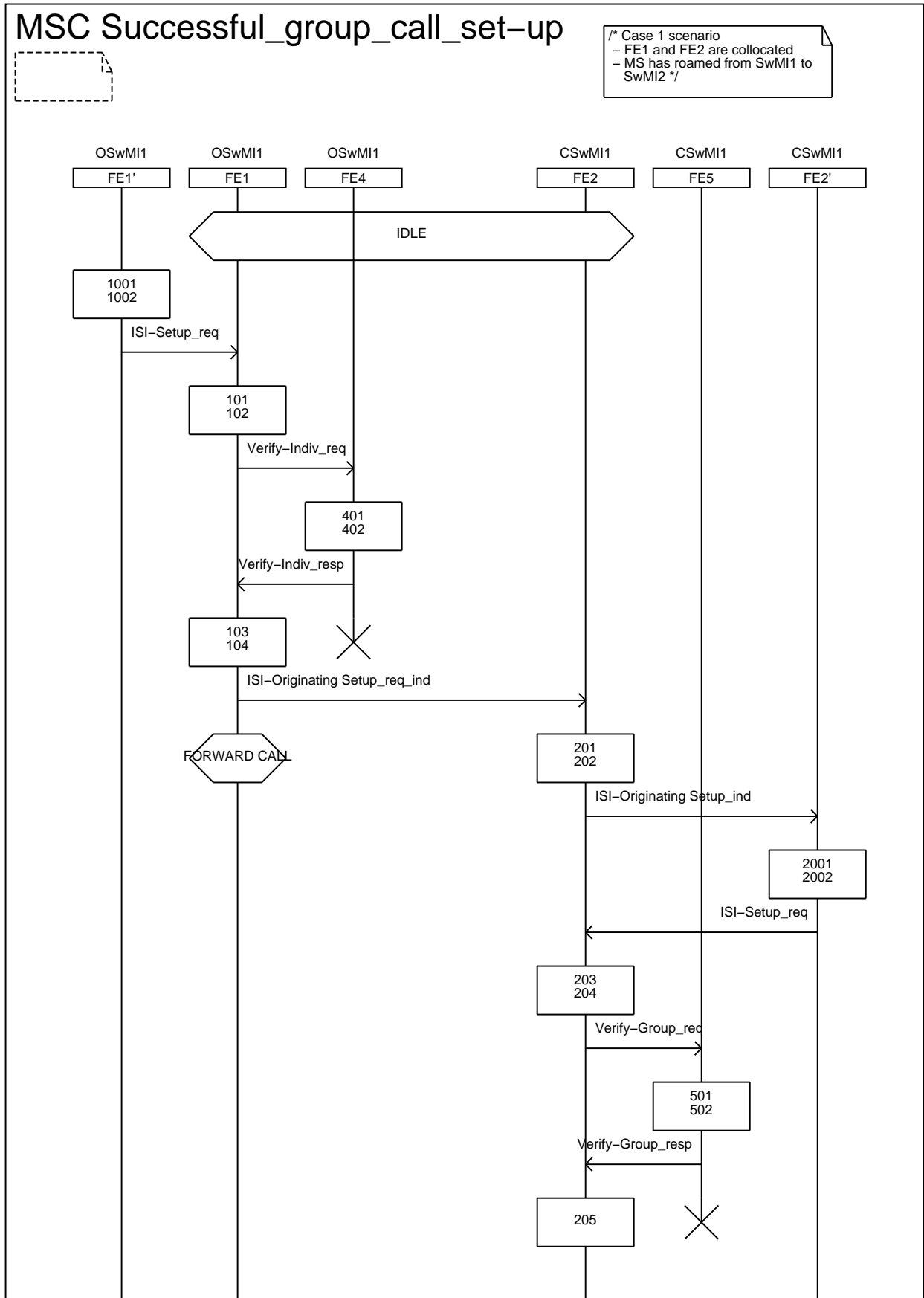
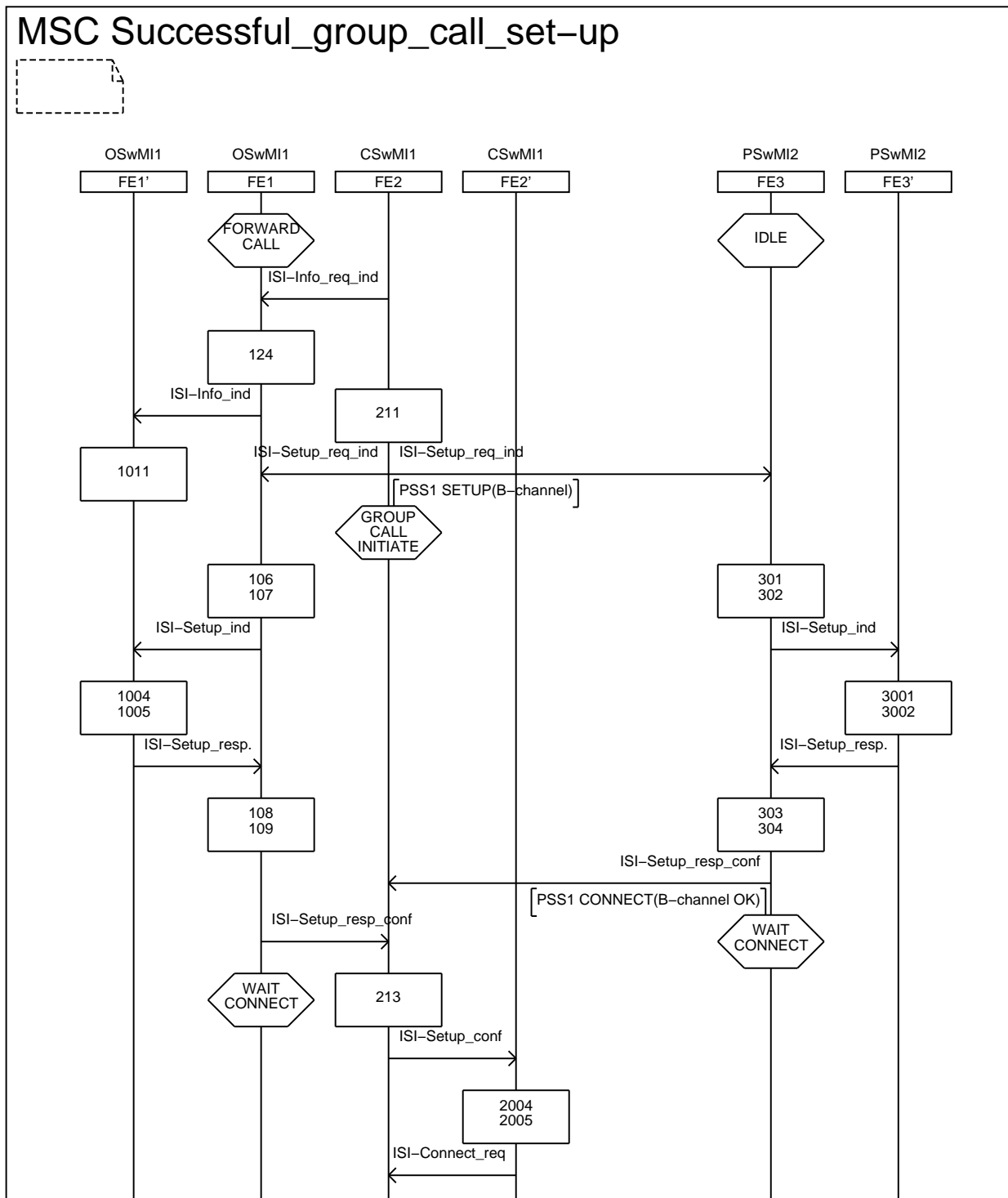


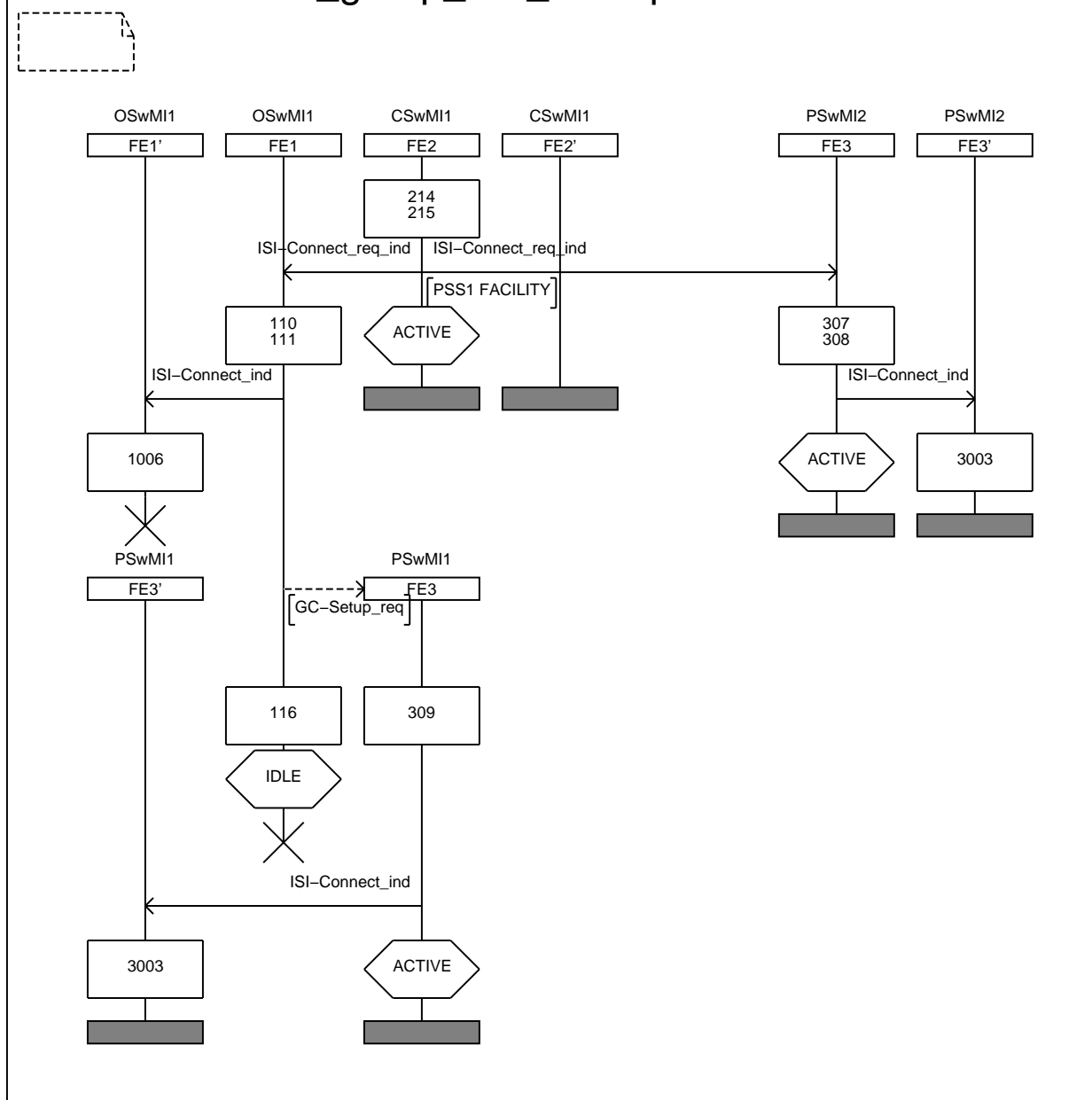
Figure 20: Information flow sequence - successful group call set-up, case 1 (sheet 1 of 3)



**Figure 21: Information flow sequence - successful group call set-up, case 1 (sheet 2 of 3)**

A PSS1 facility information element shall not be sent to the controlling SwMI before a response has been sent from the participating SwMI to the previously received PSS1 SETUP message. The PSS1 CALL PROCEEDING message shall therefore be sent from the participating SwMI before the PSS1 CONNECT message may be sent carrying TETRA PDUs.

## MSC Successful\_group\_call\_set-up



NOTE: The QSIG timer T313 (started by the originating/participating SwMI upon sending PSS1 CONNECT) is not to be implemented. The sending of PSS1 CONNECT ACKNOWLEDGE is therefore optional (ISO/IEC 11572 [11], clause 10.1.6).

**Figure 22: Information flow sequence - successful group call set-up, case 1 (sheet 3 of 3)**

FE2 shall inform FE1 and FE3 of "Setup response time-out" after reception of an ISI\_ORIGINATING SETUP req.ind. The "Setup response time-out" shall be used to inform the originating SwMI and participating SwMIs of the call set-up time used by the controlling SwMI. The "Setup response time-out" shall be contained within the information flow ISI-Setup.req.ind.

FE2 may inform FE1 of "call time-out, set-up phase" after reception of an ISI\_ORIGINATING SETUP req.ind. The "call time-out, set-up phase" may be used to inform the originating SwMI of the call set-up time used by the controlling SwMI. The "call time-out, set-up phase" shall be contained within the information flow ISI\_INFO req.ind.

FE2 may inform FE1 of the "call status" after reception of an ISI\_ORIGINATING SETUP req.ind. The "call status" should be used to inform FE1 of a possible queuing of the ISI\_ORIGINATING SETUP req.ind. within the controlling SwMI. The "call status" shall be contained within the information flow ISI\_INFO req.ind.

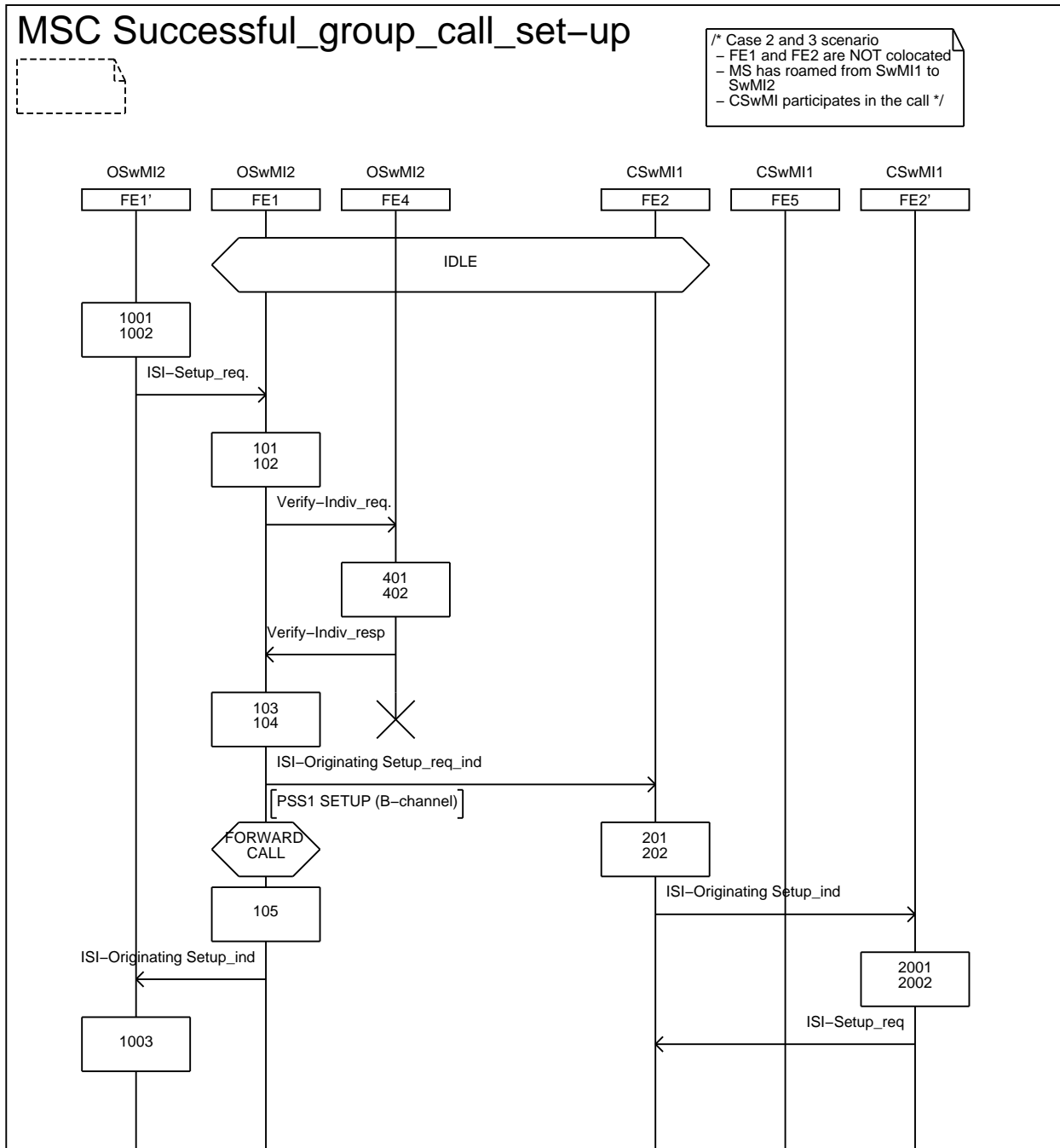
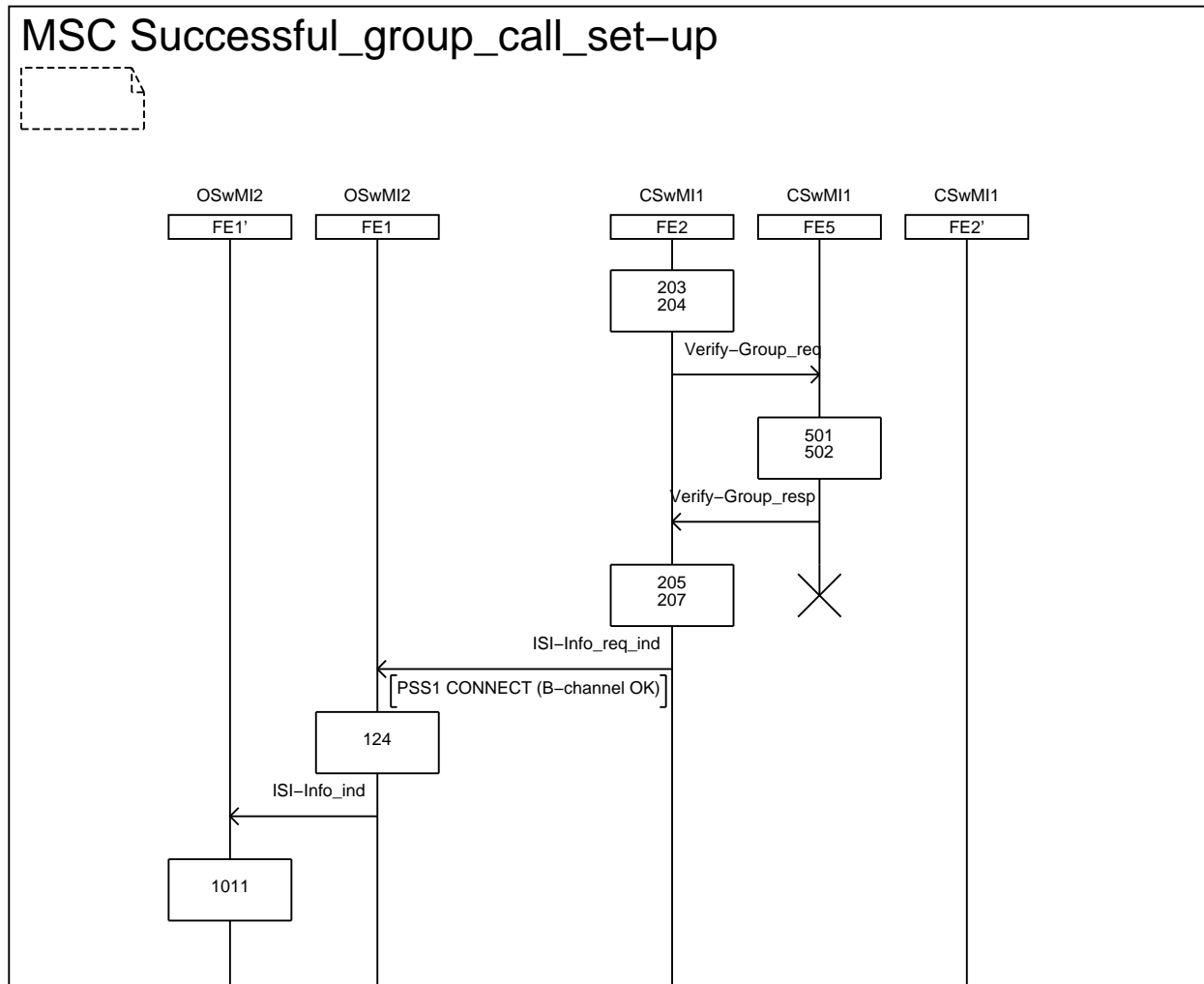


Figure 23: Information flow sequence - successful group call set-up, case 2 and 3 (sheet 1 of 4)



NOTE: According to ISO/IEC 11582 [13] clause 10, the only PSS1 messages allowed to be used for the transport of APDUs and notification information during the call establishment phase are ALERTING, CONNECT and SETUP.

**Figure 24: Information flow sequence - successful group call set-up, case 2 and 3 (sheet 2 of 4)**

A PSS1 facility information element shall not be sent by the controlling SwMI before a response has been sent to the previously received PSS1 SETUP message. The PSS1 CALL PROCEEDING message shall therefore be sent before the PSS1 CONNECT message may be sent carrying TETRA PDUs.



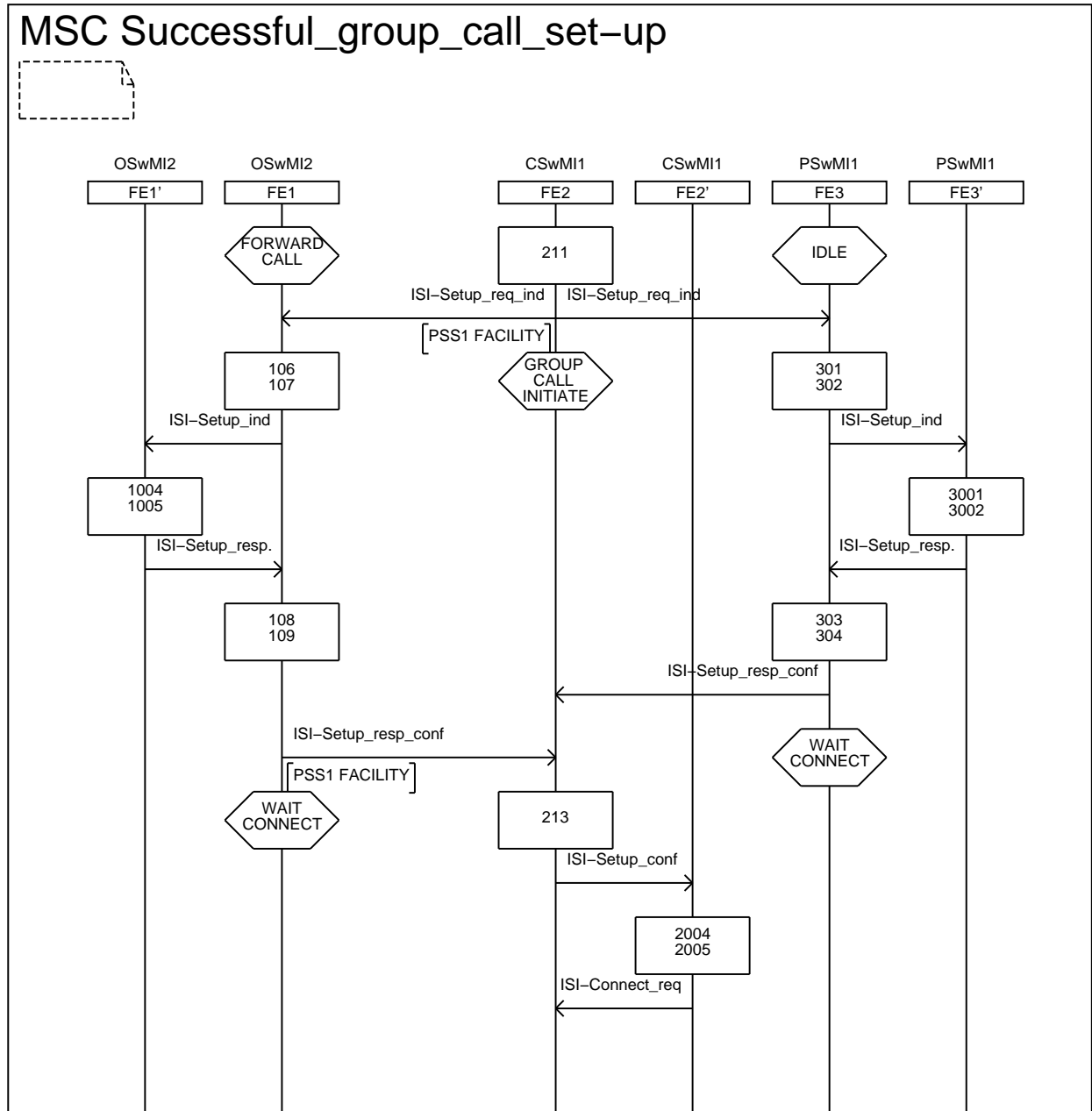
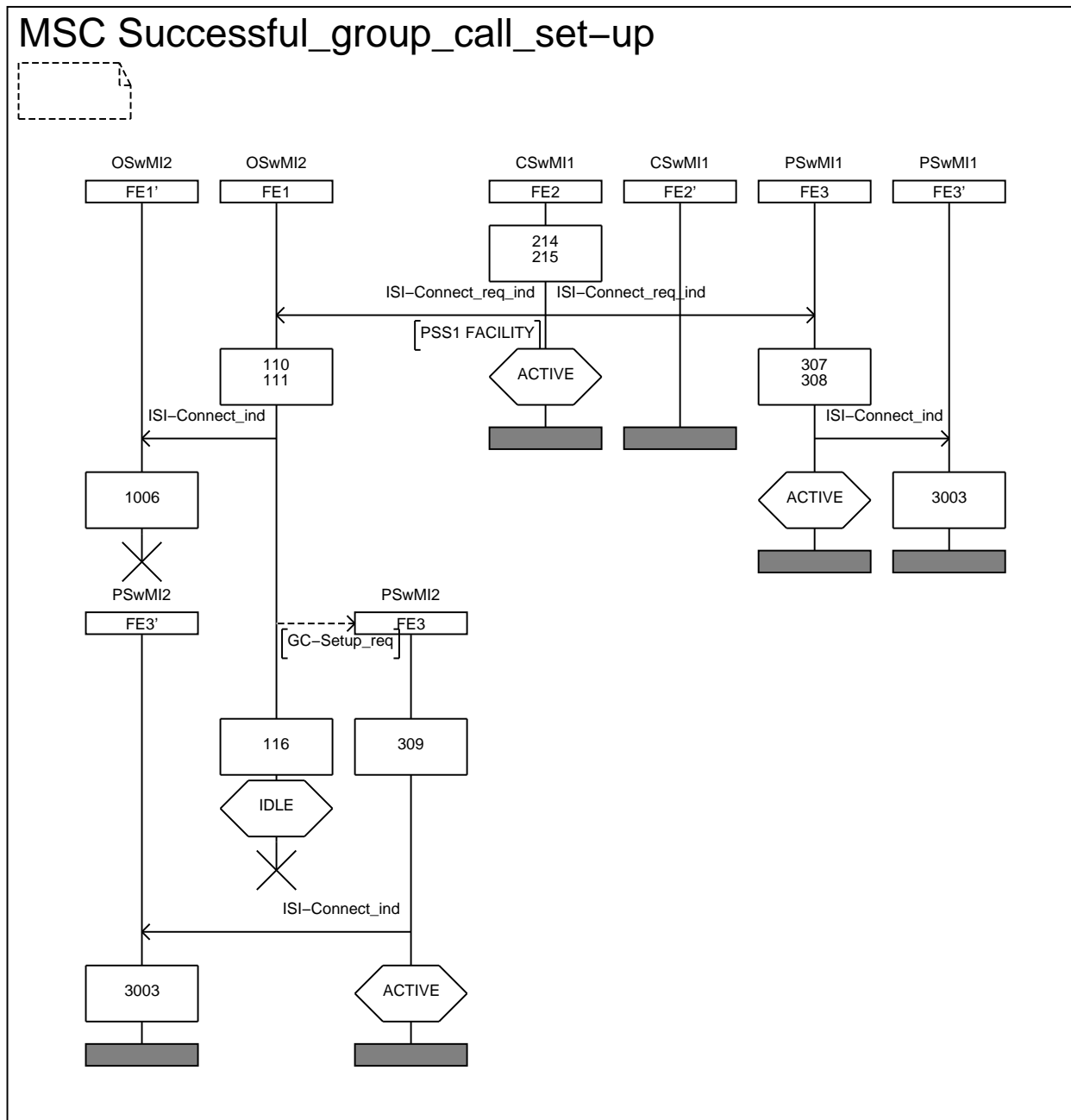


Figure 25: Information flow sequence - successful group call set-up, case 2 and 3 (sheet 3 of 4)



NOTE: The QSIG timer T313 (started by the originating/participating SwMI upon sending PSS1 CONNECT) is not to be implemented. The sending of PSS1 CONNECT ACKNOWLEDGE is therefore optional (ISO/IEC 11572 [11], clause 10.1.6).

**Figure 26: Information flow sequence - successful group call set-up, case 2 and 3 (sheet 4 of 4)**

FE2 shall inform FE1 and FE3 of "Setup response time-out" after reception of an ISI\_ORIGINATING SETUP req.ind. The "Setup response time-out" shall be used to inform the originating SwMI and participating SwMIs of the call set-up time used by the controlling SwMI. The "Setup response time-out" shall be contained within the information flow ISI-Setup.req.ind.

FE2 may inform FE1 of "call time-out, set-up phase" after reception of an ISI\_ORIGINATING SETUP req.ind. The "call time-out, set-up phase" may be used to inform the originating SwMI of the call set-up time used by the controlling SwMI. The "call time-out, set-up phase" shall be contained within the information flow ISI\_INFO req.ind and carried by the PSS1 CONNECT message.

FE2 may inform FE1 of the "call status" after reception of an ISI\_ORIGINATING SETUP req.ind. The "call status" should be used to inform FE1 of a possible queuing of the ISI\_ORIGINATING SETUP req.ind. within the controlling SwMI. The "call status" shall be contained within the information flow ISI\_INFO req.ind. and carried by the PSS1 CONNECT message.

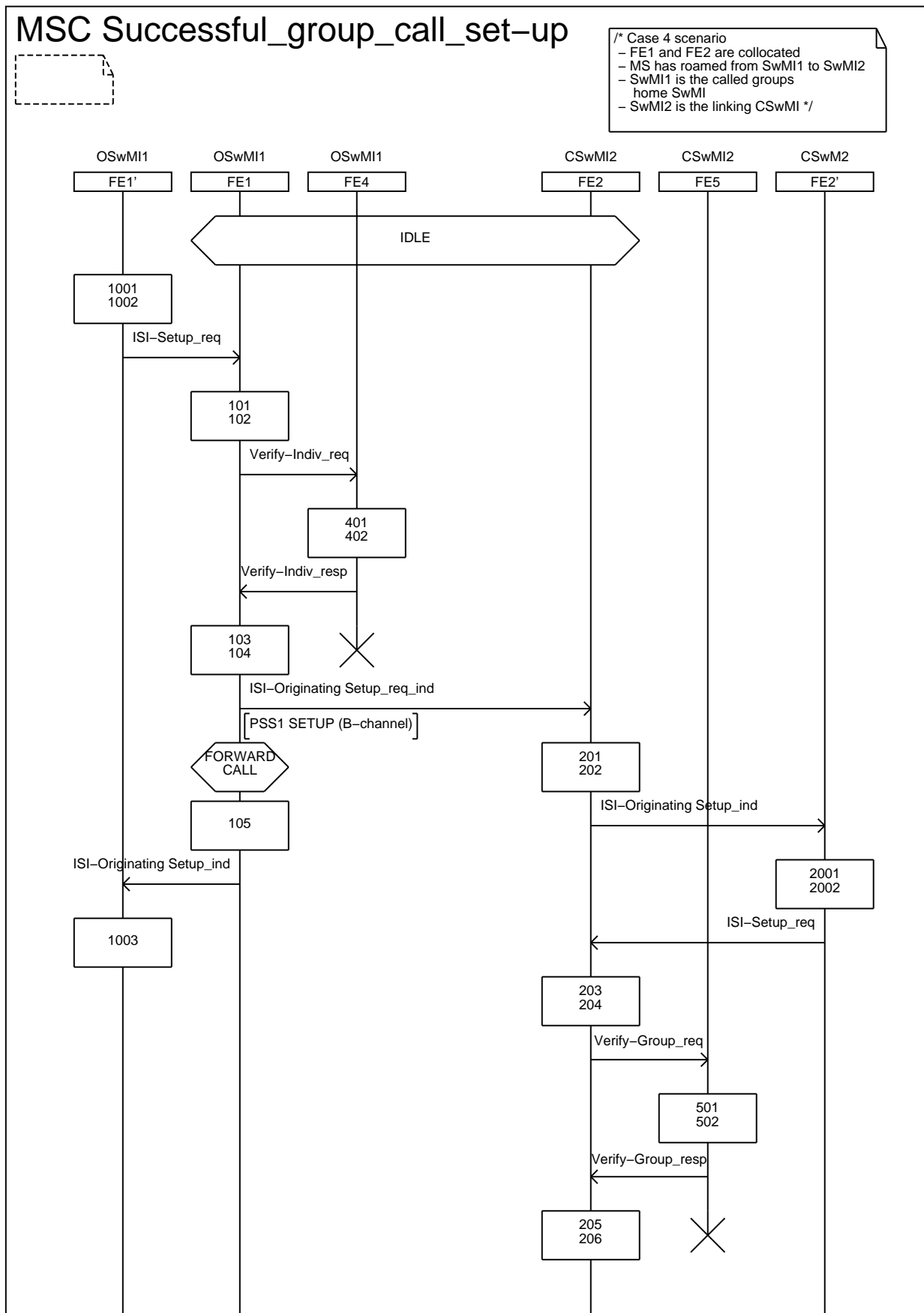
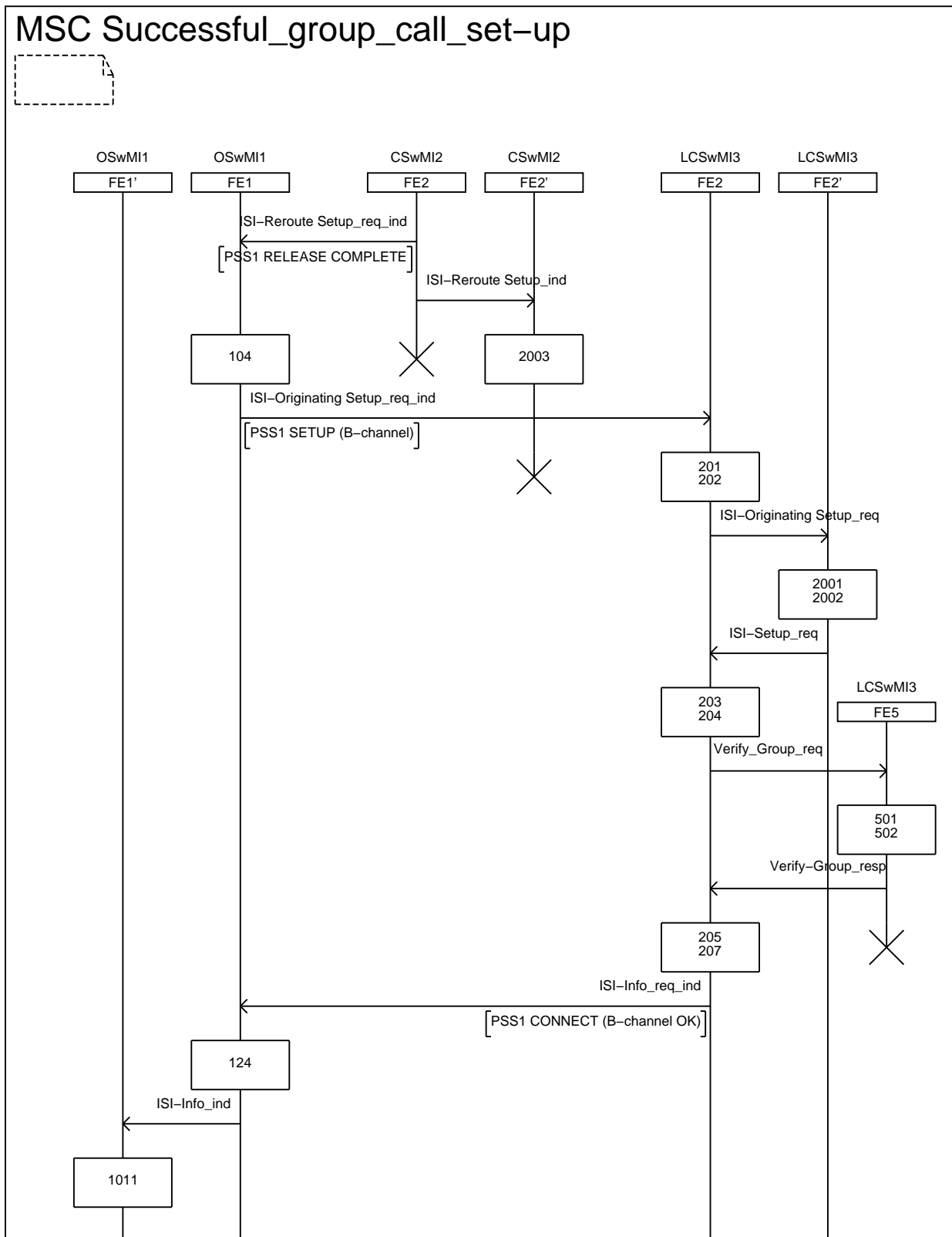


Figure 27: Information flow sequence - successful group call set-up, case 4 (sheet 1 of 4)



**Figure 28: Information flow sequence - successful group call set-up, case 4 (sheet 2 of 4)**

A PSS1 facility information element shall not be sent by the controlling SwMI before a response has been sent to the previously received PSS1 SETUP message. The PSS1 CALL PROCEEDING message shall therefore be sent before the PSS1 CONNECT message may be sent carrying TETRA PDUs.

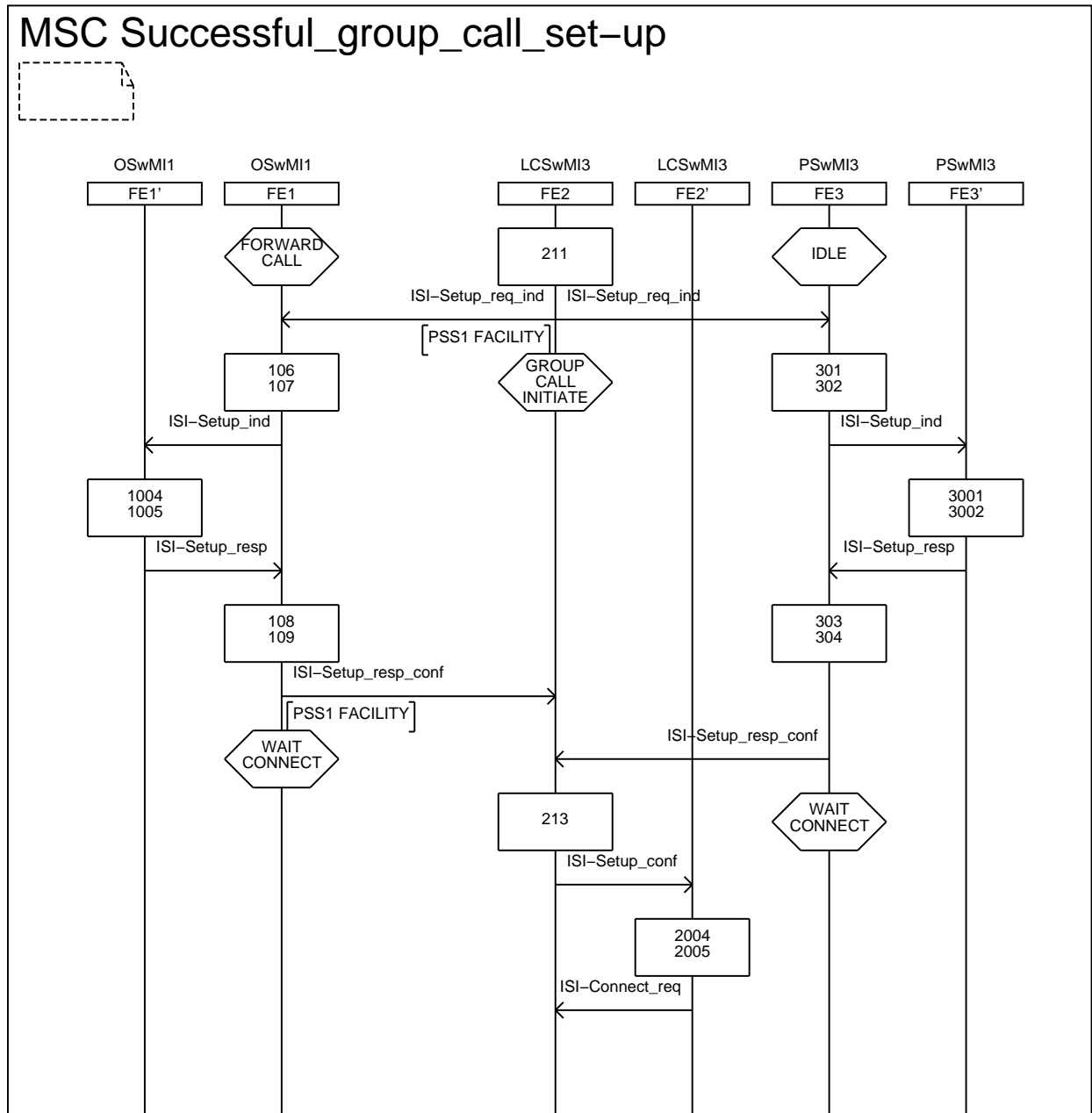
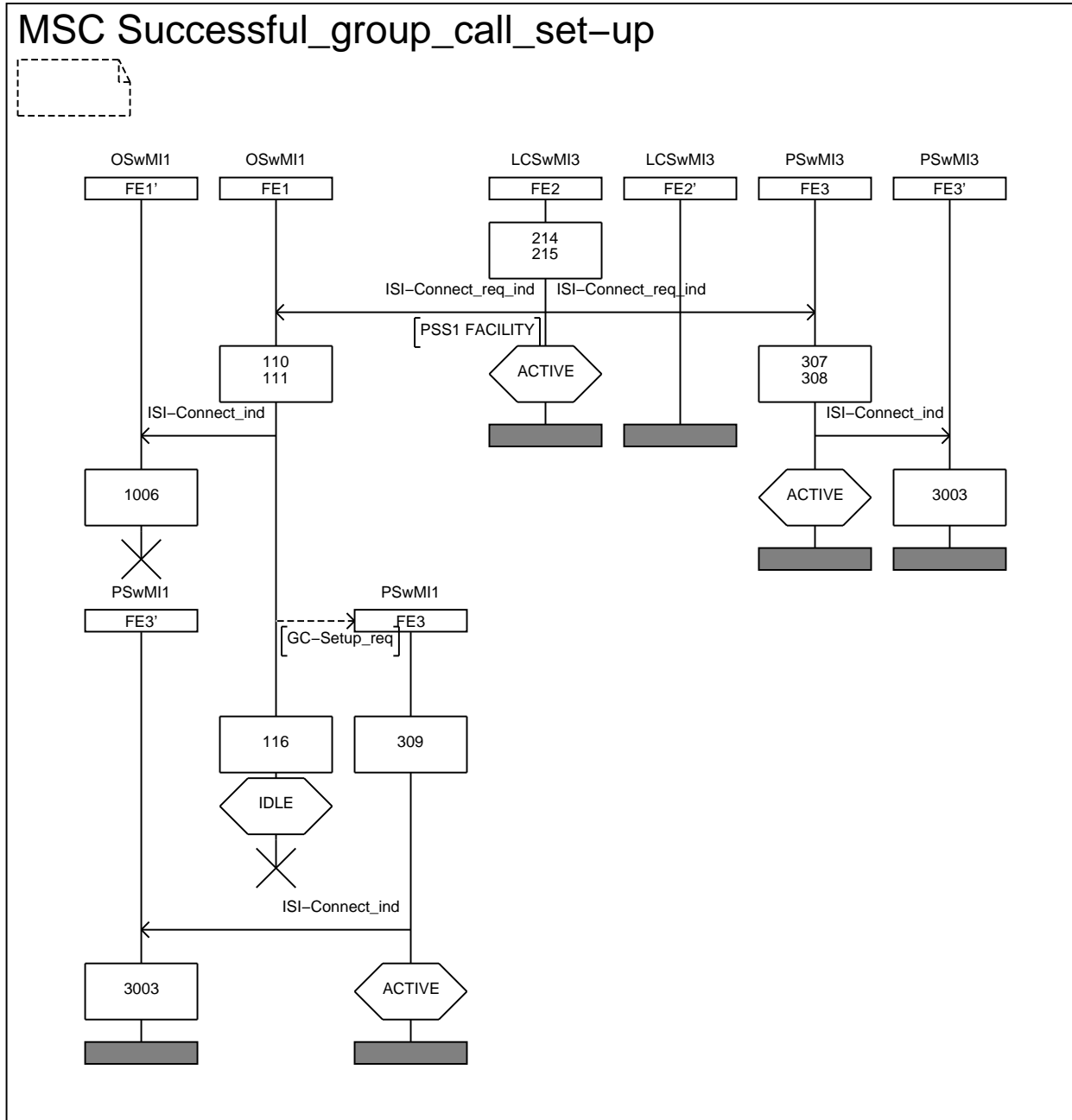


Figure 29: Information flow sequence - successful group call set-up, case 4 (sheet 3 of 4)



NOTE: The QSIG timer T313 (started by the originating/participating SwMI upon sending PSS1 CONNECT) is not to be implemented. The sending of PSS1 CONNECT ACKNOWLEDGE is therefore optional (ISO/IEC 11572 [11], clause 10.1.6).

**Figure 30: Information flow sequence - successful group call set-up, case 4 (sheet 4 of 4)**

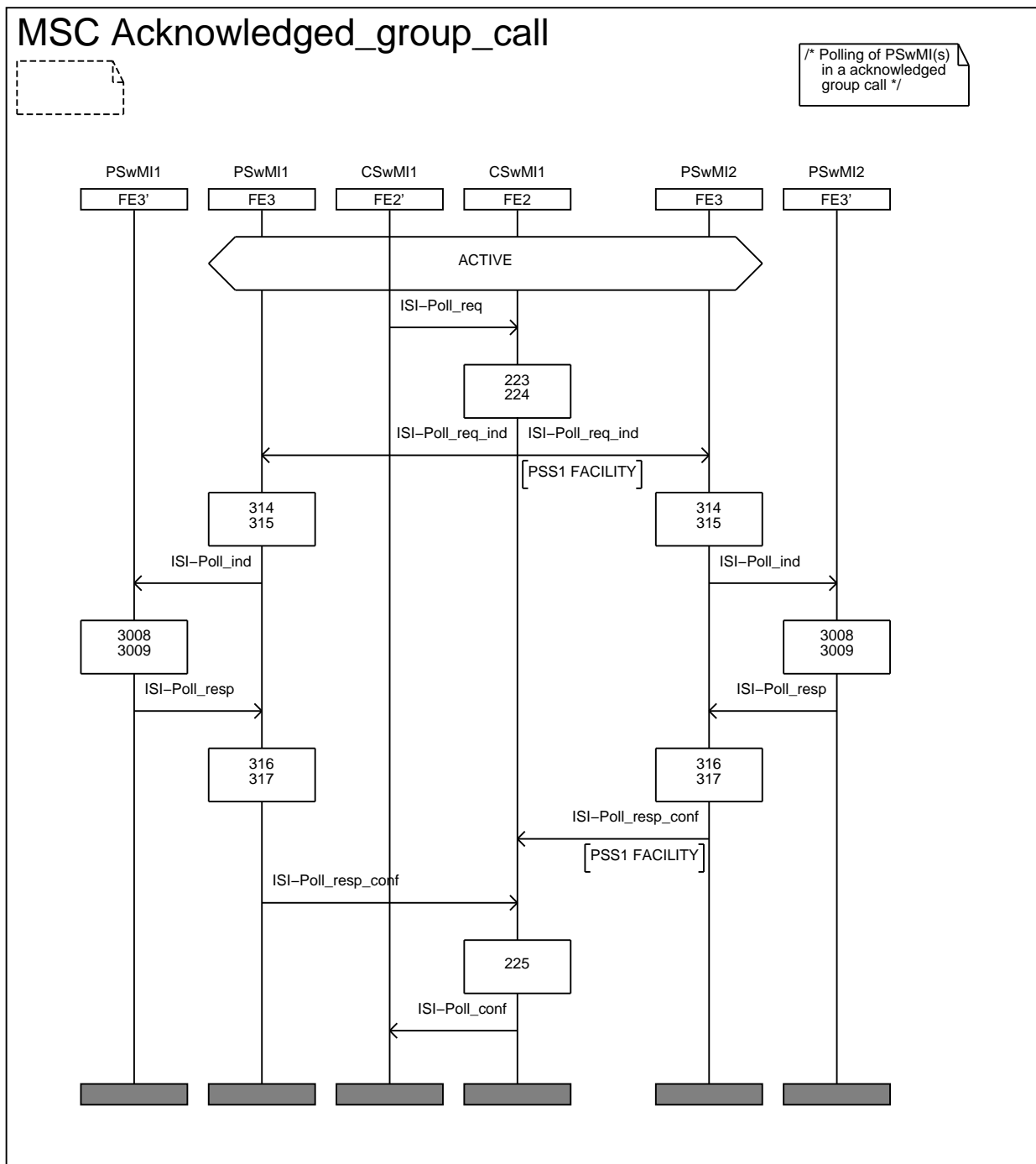
FE2 shall inform FE1 and FE3 of "Setup response time-out" after reception of an ISI\_ORIGINATING SETUP req.ind. The "Setup response time-out" shall be used to inform the originating SwMI and participating SwMIs of the call set-up time used by the controlling SwMI. The "Setup response time-out" shall be contained within the information flow ISI-Setup.req.ind.

FE2 may inform FE1 of "call time-out, set-up phase" after reception of an ISI\_ORIGINATING SETUP req.ind. The "call time-out, set-up phase" may be used to inform the originating SwMI of the call set-up time used by the controlling SwMI. The "call time-out, set-up phase" shall be contained within the information flow ISI\_INFO req.ind and carried by the PSS1 CONNECT message.

FE2 may inform FE1 of the "call status" after reception of an ISI\_ORIGINATING SETUP req.ind. The "call status" should be used to inform FE1 of a possible queuing of the ISI\_ORIGINATING SETUP req.ind. within the controlling SwMI. The "call status" shall be contained within the information flow ISI\_INFO req.ind. and carried by the PSS1 CONNECT message.

### 5.2.1.2 Acknowledged group call set-up over ISI using ANF-ISIGC

For acknowledged group calls, participating SwMIs shall first be polled after the group call has been successfully set-up. The group call set-up sequence for acknowledged group calls shall comply to the set-up sequences shown in figures 20 to 30.



NOTE: FE2 may at any time send FE3 the polling result contained within the information flow ISI\_INFO req.ind.

Figure 31: Information flow sequence - successful acknowledged group call set-up



### 5.2.1.3 Partial group call set-up over ISI using ANF-ISIGC

The group call has been initiated as shown for case scenarios 1 through 4, figures 20 to 30.

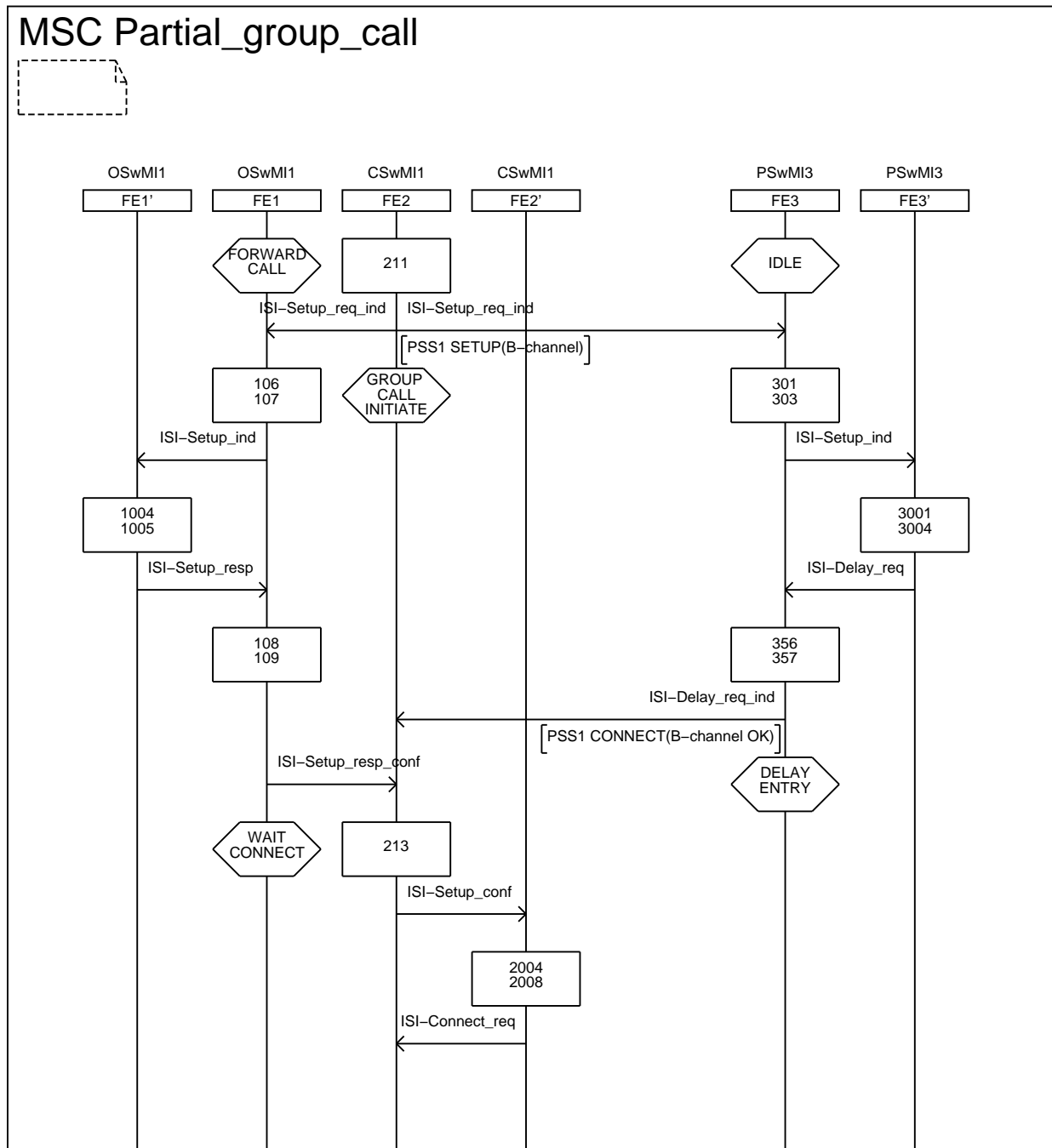
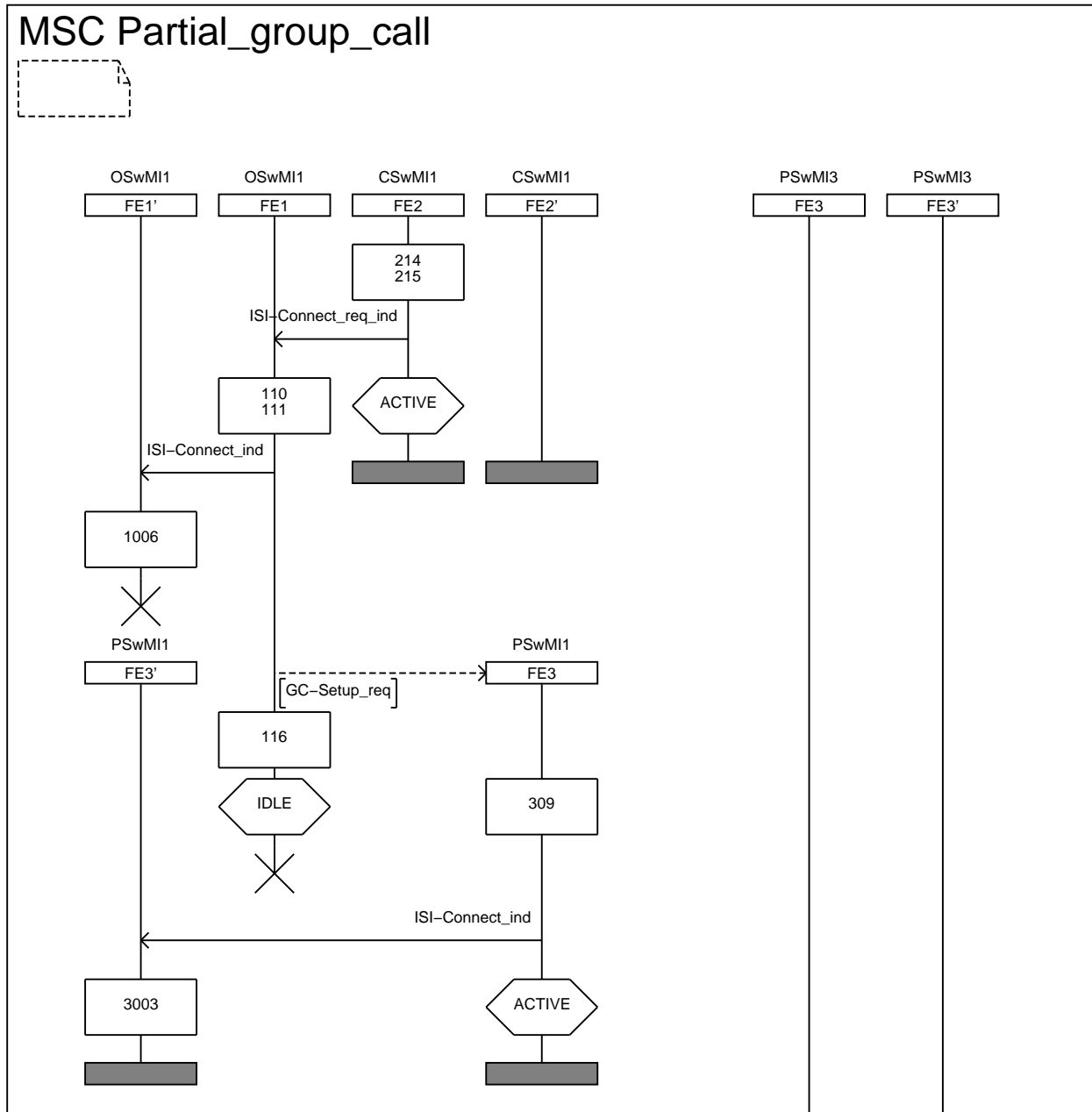


Figure 32: Information flow sequence - partial group call set-up (sheet 1 of 3)

A PSS1 facility information element shall not be sent by the controlling SwMI before a response has been sent to the previously received PSS1 SETUP message. The PSS1 CALL PROCEEDING message shall therefore be sent before the PSS1 CONNECT message may be sent carrying TETRA PDUs.



NOTE: The QSIG timer T313 (started by the originating/participating SwMI upon sending PSS1 CONNECT) is not to be implemented. The sending of PSS1 CONNECT ACKNOWLEDGE is therefore optional (ISO/IEC 11572 [11], clause 10.1.6).

**Figure 33: Information flow sequence - partial group call set-up (sheet 2 of 3)**

# MSC Partial\_group\_call

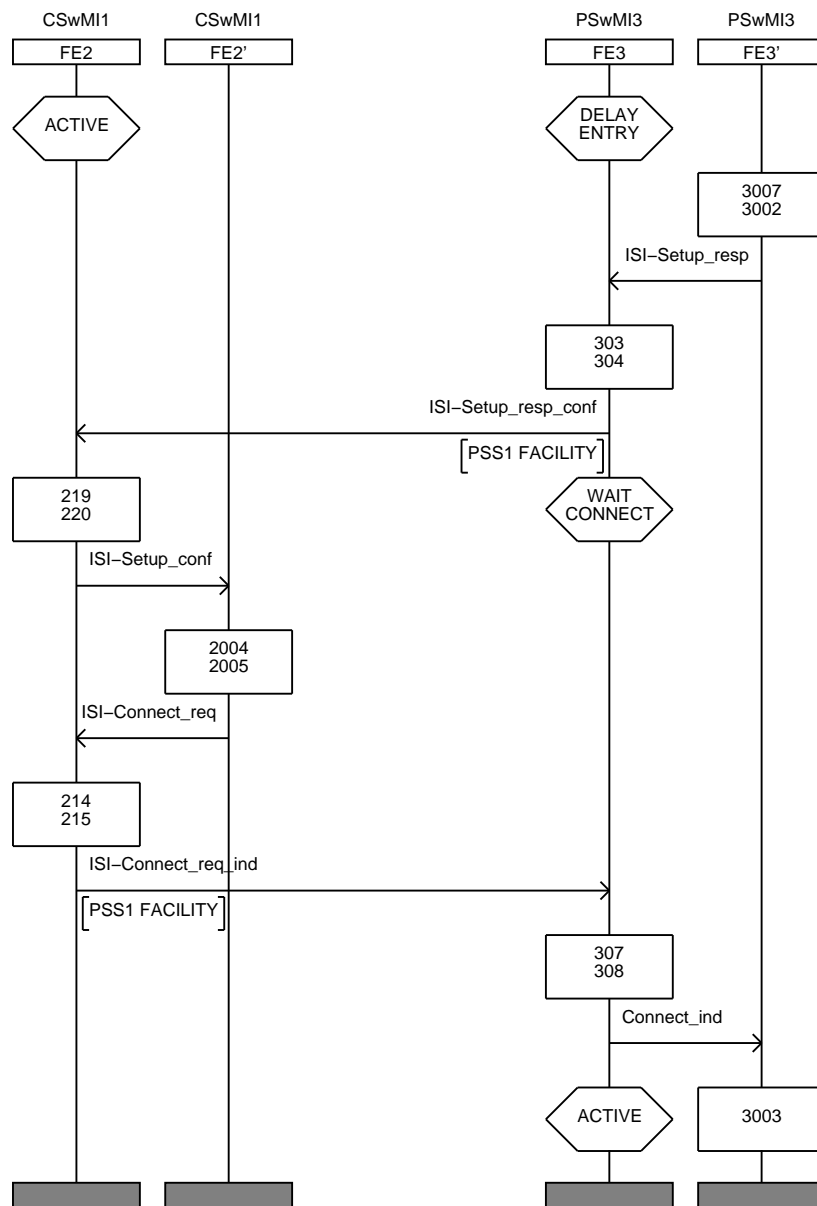
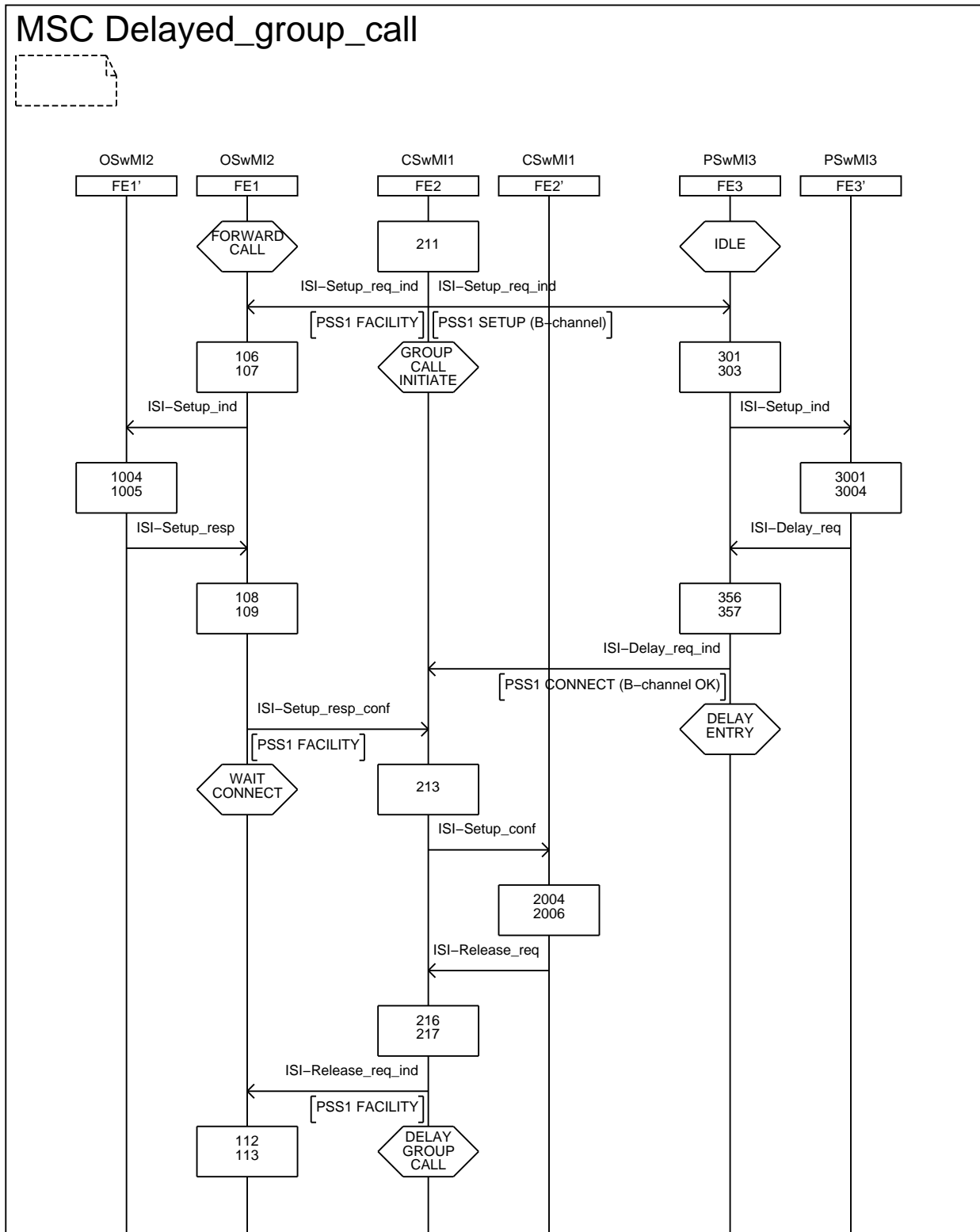


Figure 34: Information flow sequence - partial group call set-up (sheet 3 of 3)

5.2.1.4 Delay of group call set-up over ISI using ANF-ISIGC

The group call has been initiated as shown for case scenarios 1 through 4, figures 20 to 30.



NOTE: The QSIG timer T313 (started by the originating/participating SwMI upon sending PSS1 CONNECT) is not to be implemented. The sending of PSS1 CONNECT ACKNOWLEDGE is therefore optional (ISO/IEC 11572 [11], clause 10.1.6).

Figure 35: Information flow sequence - delayed group call set-up (sheet 1 of 4)

A PSS1 facility information element shall not be sent by the controlling SwMI before a response has been sent to the previously received PSS1 SETUP message. The PSS1 CALL PROCEEDING message shall therefore be sent before the PSS1 CONNECT message may be sent carrying TETRA PDUs.

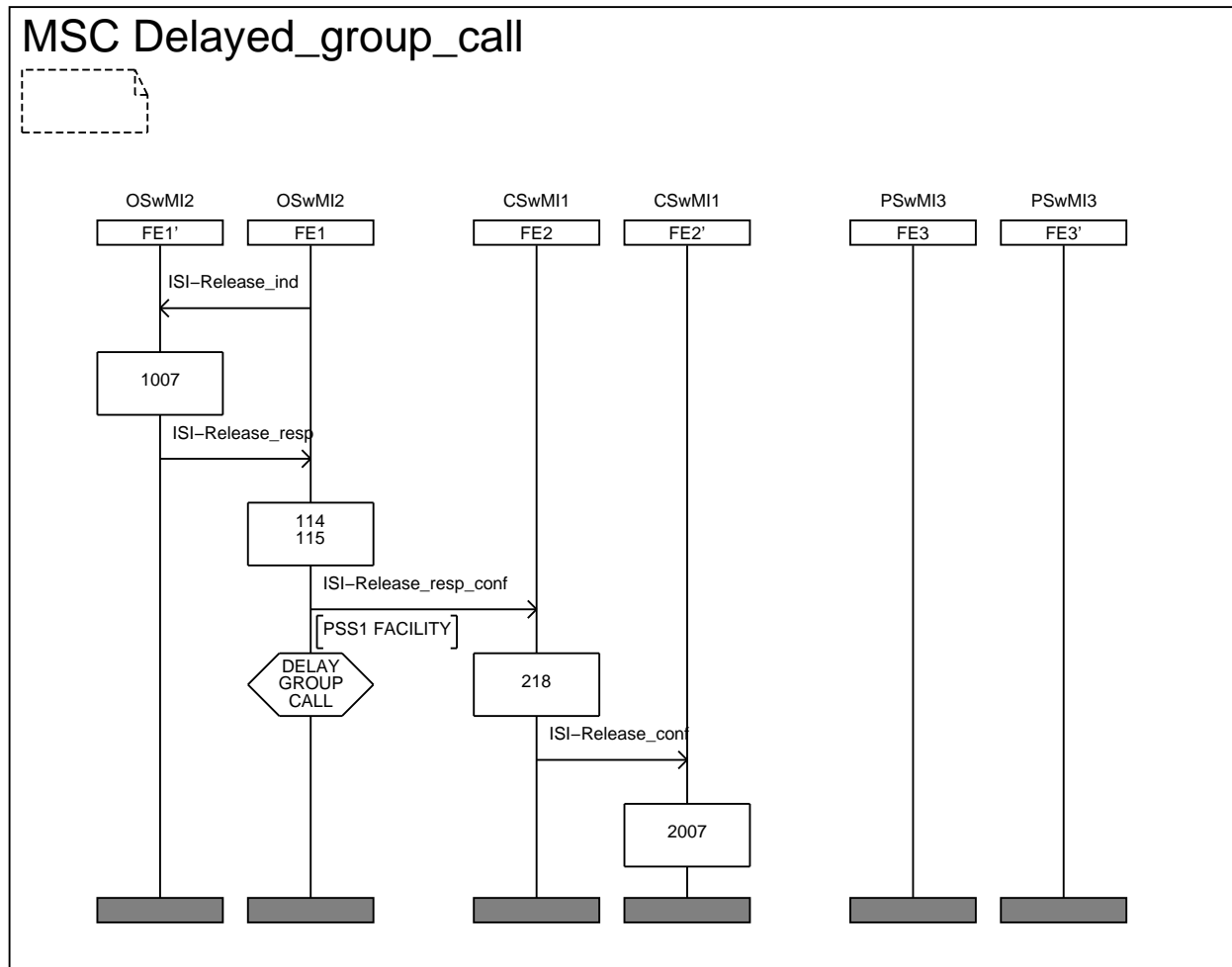


Figure 36: Information flow sequence - delayed group call set-up (sheet 2 of 4)

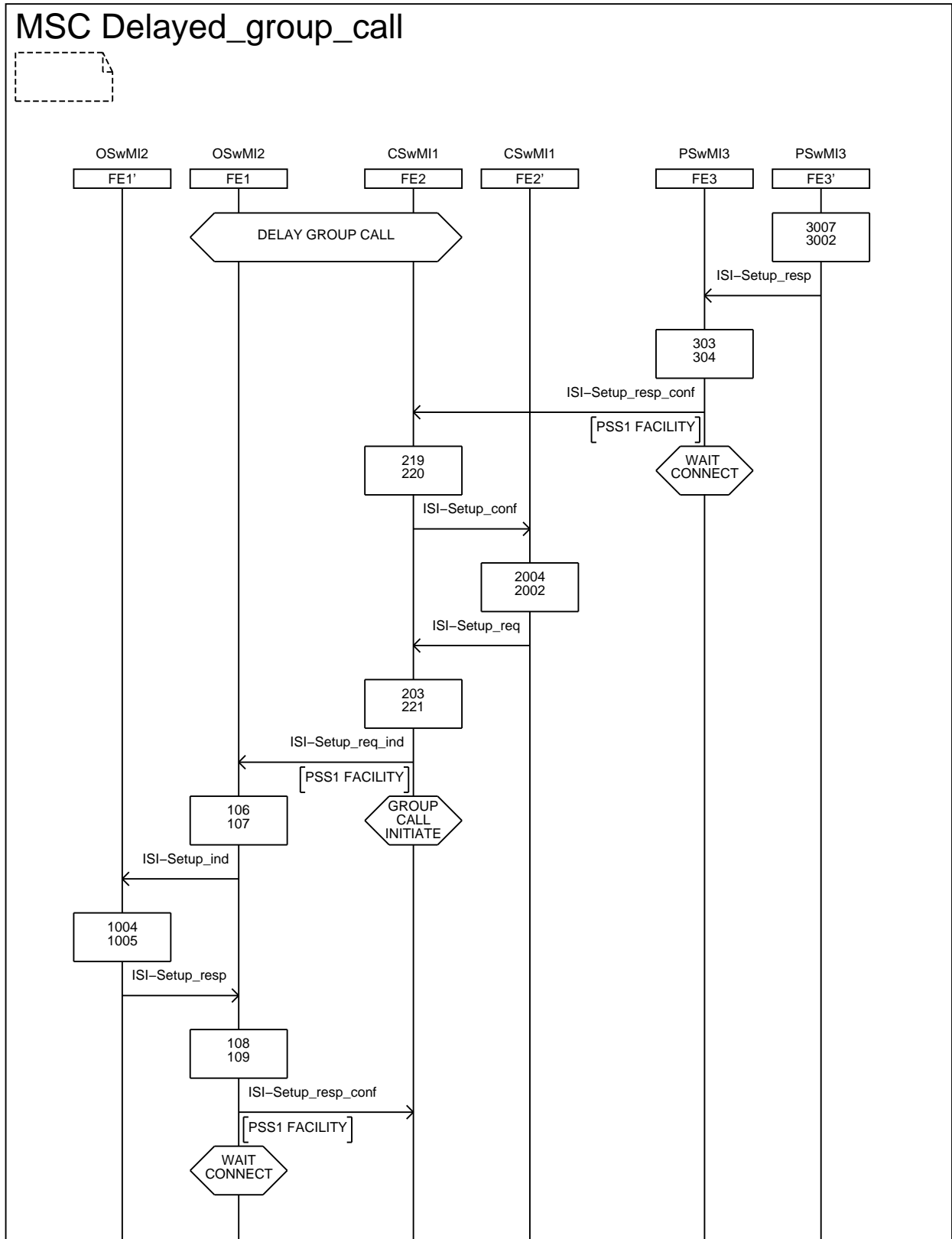


Figure 37: Information flow sequence - delayed group call set-up (sheet 3 of 4)

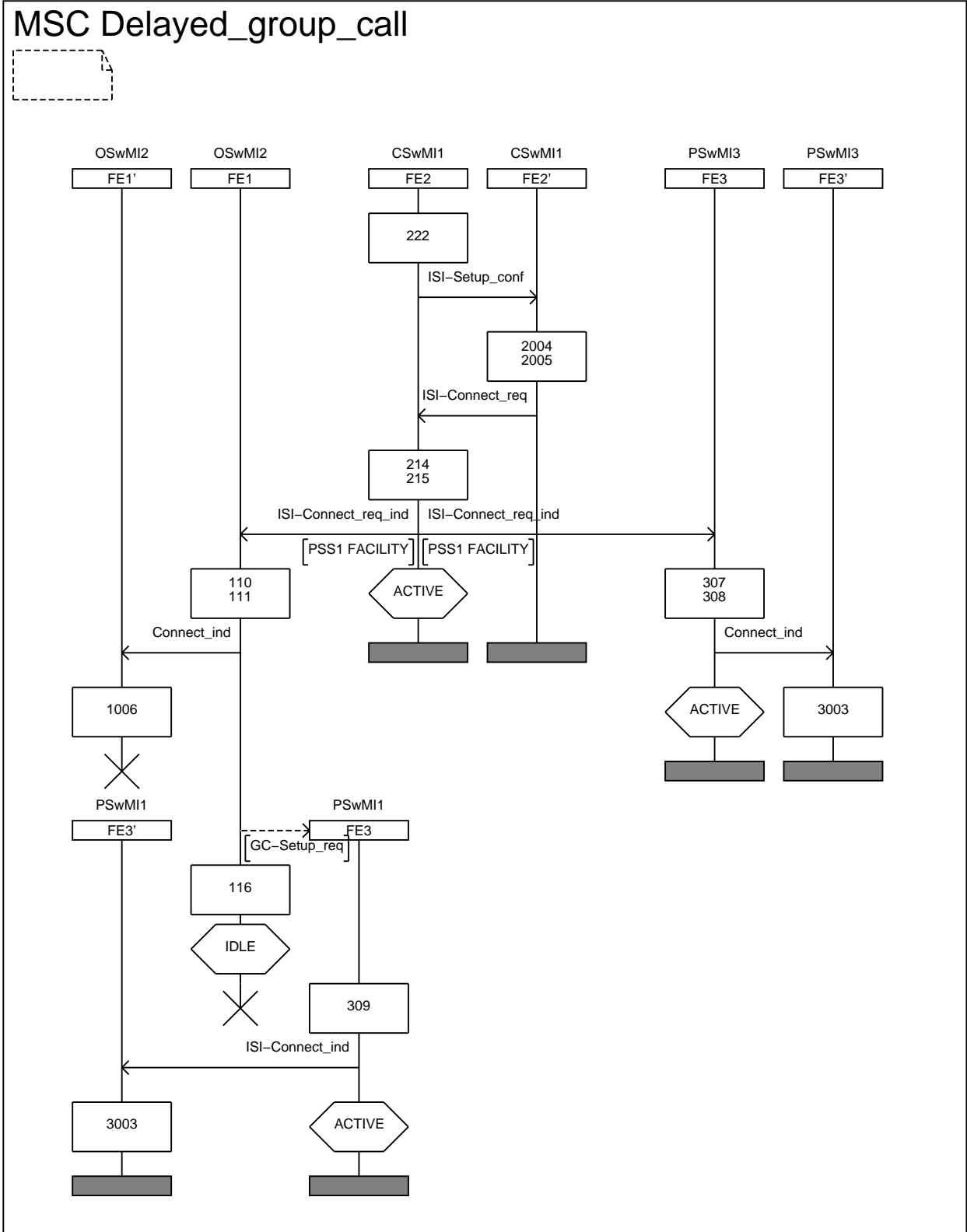


Figure 38: Information flow sequence - delayed group call set-up (sheet 4 of 4)

### 5.2.1.5 Interaction with an active group call

Figures 39 and 40 show the information flow when an individual TETRA user makes a call to a group already active in a call. Upon acceptance from the controlling SwMI call control application, the invoked ANF-ISIGC entity shall be merged into the call. If the active call is an intra-TETRA call, then an ISI connection shall be set-up to the new SwMI by the ANF-ISIGC entity in the controlling SwMI.

If the active call is an inter-TETRA call then the invoked ANF-ISIGC entity shall be merged with the ANF-ISIGC entity for the active call.

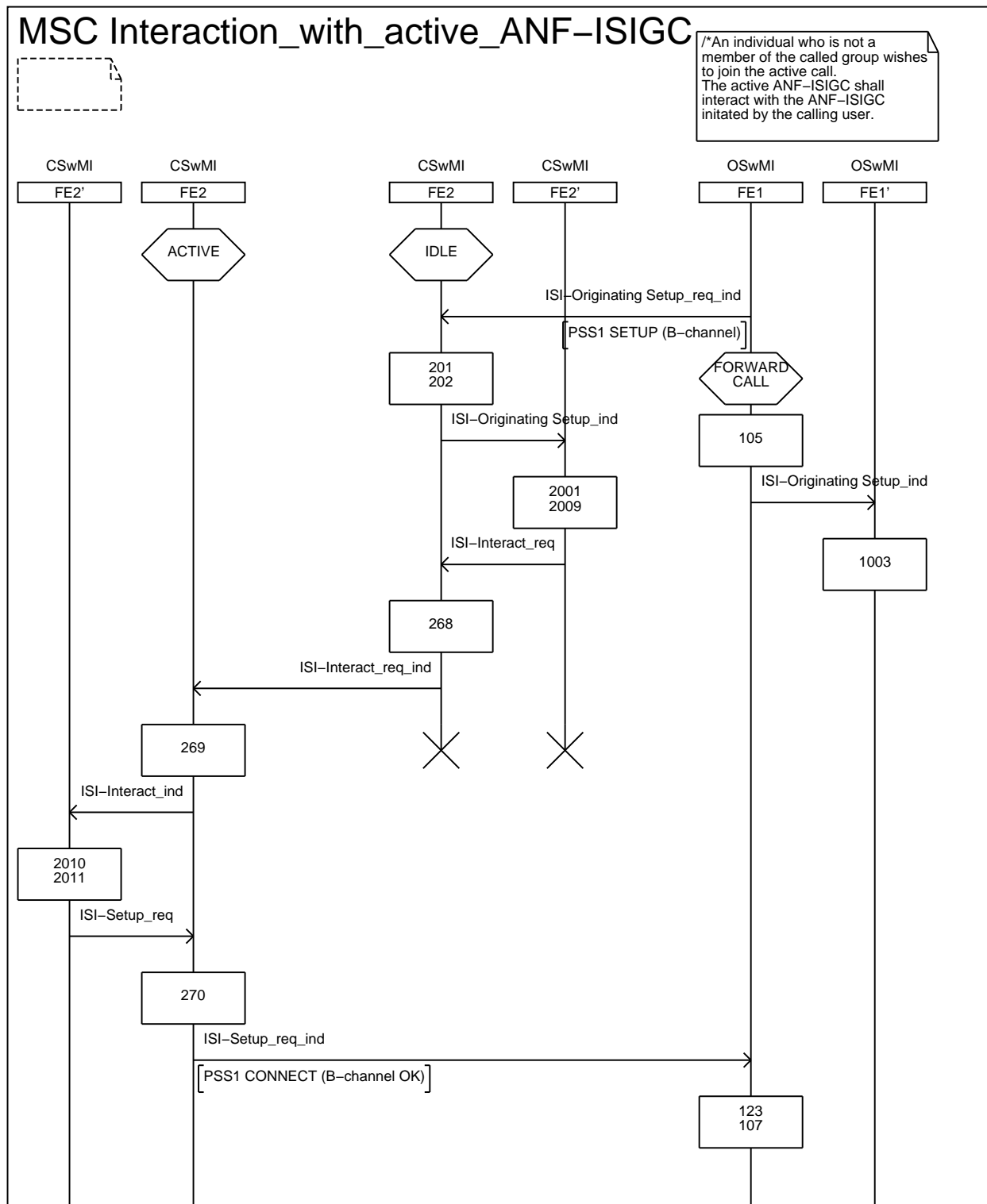
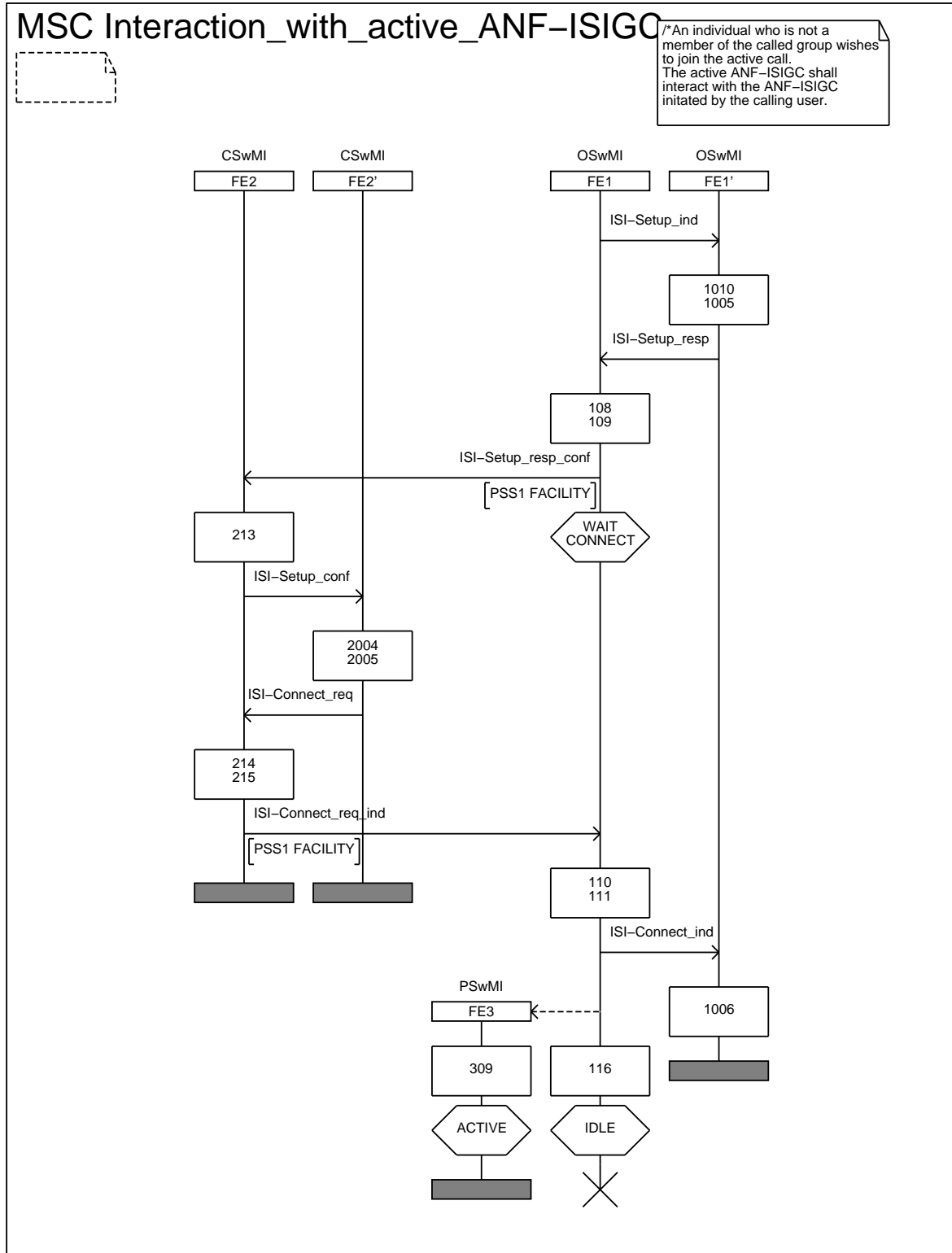


Figure 39: Information flow sequence - Interaction with active ANF-ISIGC (sheet 1 of 2)



A PSS1 facility information element shall not be sent by the controlling SwMI before a response has been sent to the previously received PSS1 SETUP message. The PSS1 CALL PROCEEDING message shall therefore be sent before the PSS1 CONNECT message may be sent carrying TETRA PDUs.



NOTE: The QSIG timer T313 (started by the originating/participating SwMI upon sending PSS1 CONNECT) is not to be implemented. The sending of PSS1 CONNECT ACKNOWLEDGE is therefore optional (ISO/IEC 11572 [11], clause 10.1.6).

Figure 40: Information flow sequence - Interaction with active ANF-ISIGC (sheet 2 of 2)

## 5.2.1.6 Unsuccessful group call set-up over ISI using ANF-ISIGC

Figures 41 to 45 show the information flow sequence for an unsuccessful group call set-up using ANF-ISIGC. The unsuccessful scenarios cover all four cases from clause 4.2.2.3.1 and is a result of call rejection by the controlling SwMI, group home SwMI or participating SwMI.

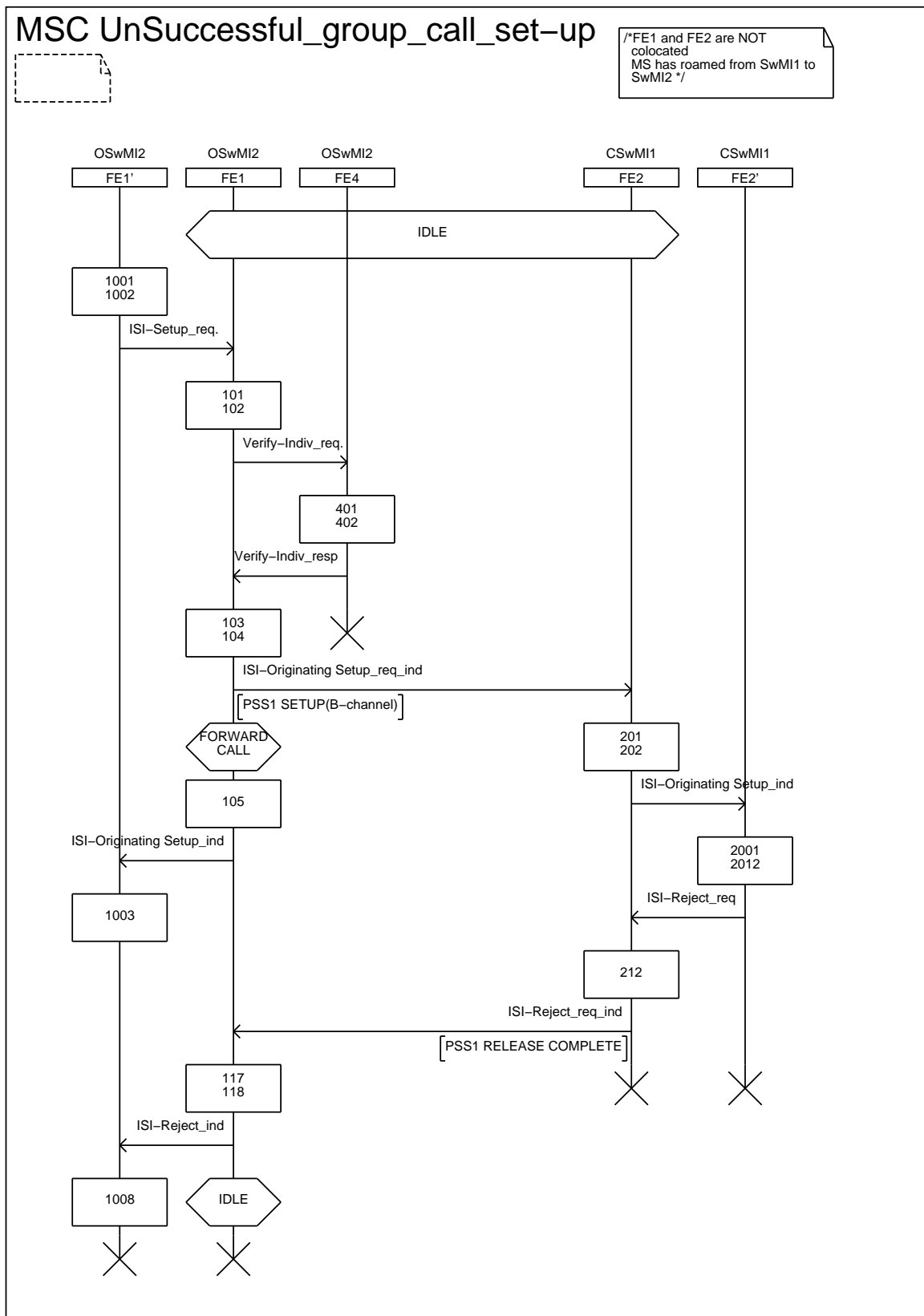


Figure 41: Information flow sequence - group home SwMI rejects the call

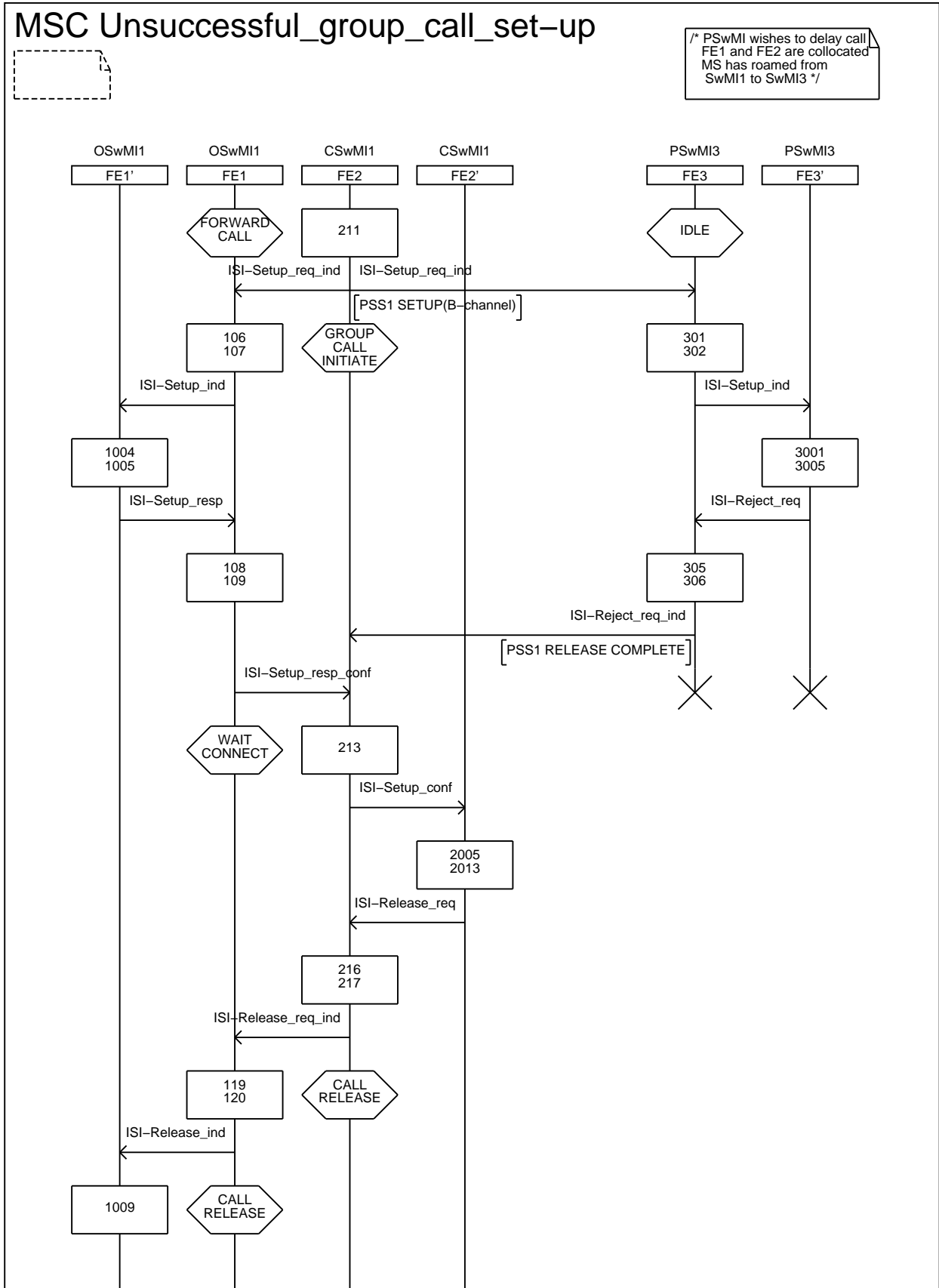


Figure 42: Information flow sequence - controlling SwMI rejects the call (sheet 1 of 2)

# MSC Unsuccessful\_group\_call\_set-up

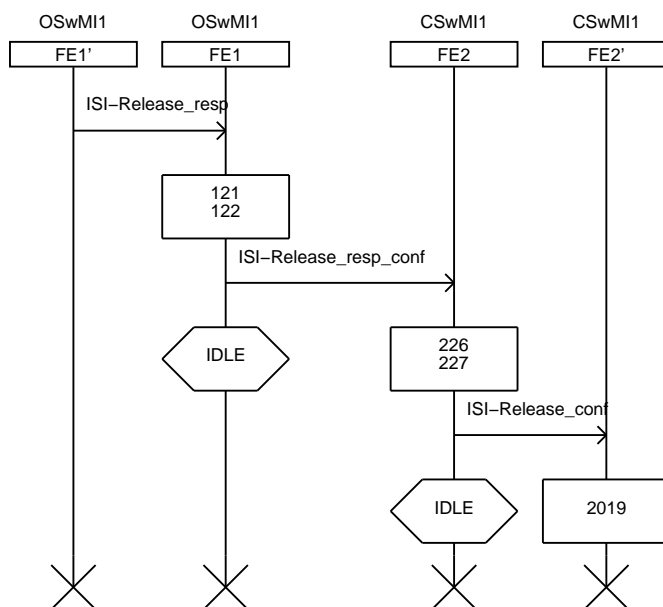


Figure 43: Information flow sequence - controlling SwMI rejects the call (sheet 2 of 2)

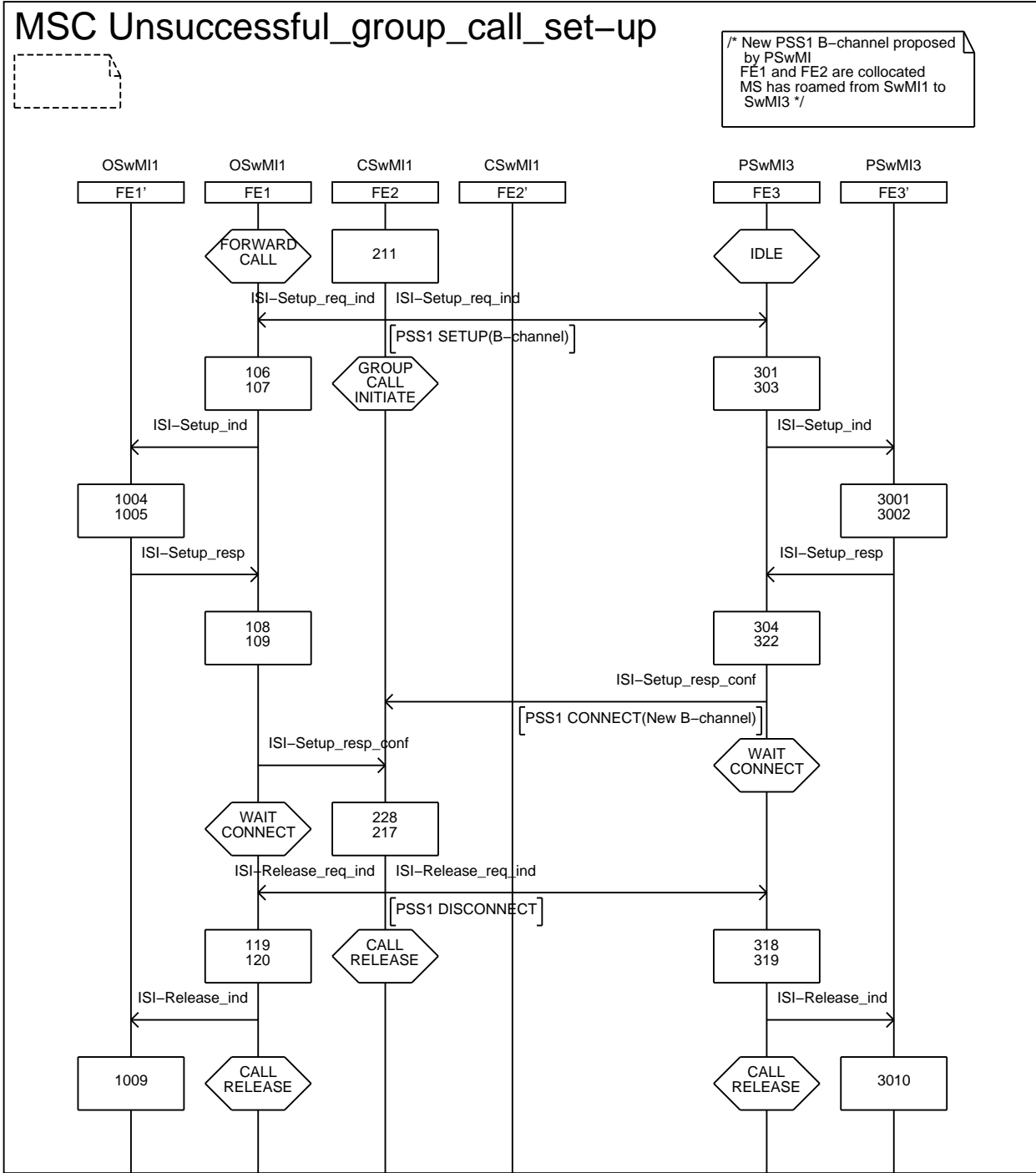


Figure 44: Information flow sequence - new B-channel not accepted (sheet 1 of 2)

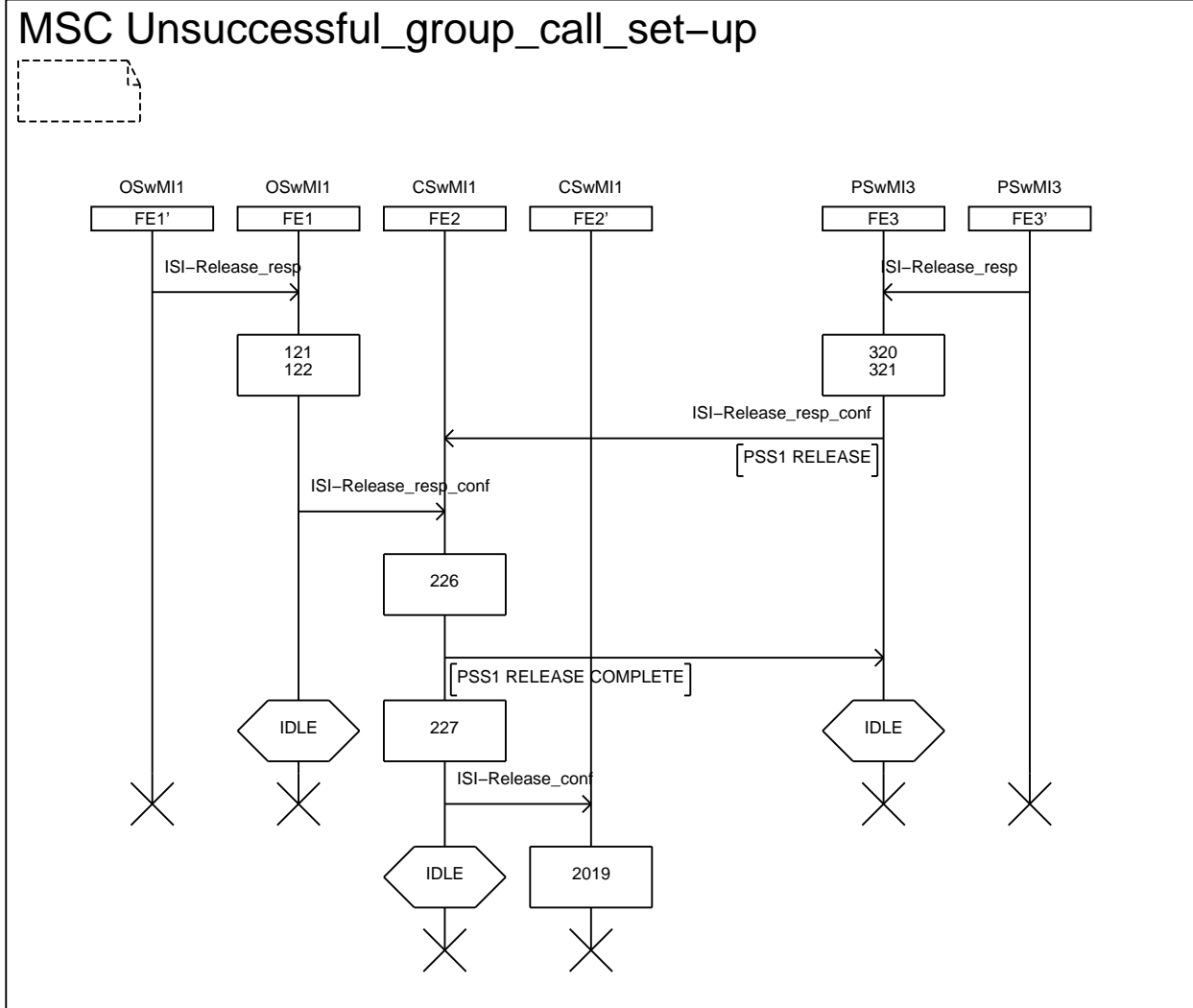


Figure 45: Information flow sequence - new B-channel not accepted (sheet 2 of 2)

5.2.1.7 Call Maintenance procedures - Request to transmit

Figures 46 to 54 show the information flow sequence for a request to transmit from a TETRA user in a participating SwMI and the possible request and granting responses from the controlling SwMI. All participating SwMIs involved in the call shall receive a group addressed ISI\_TX\_GRANTED PDU when transmission has been granted to a user.

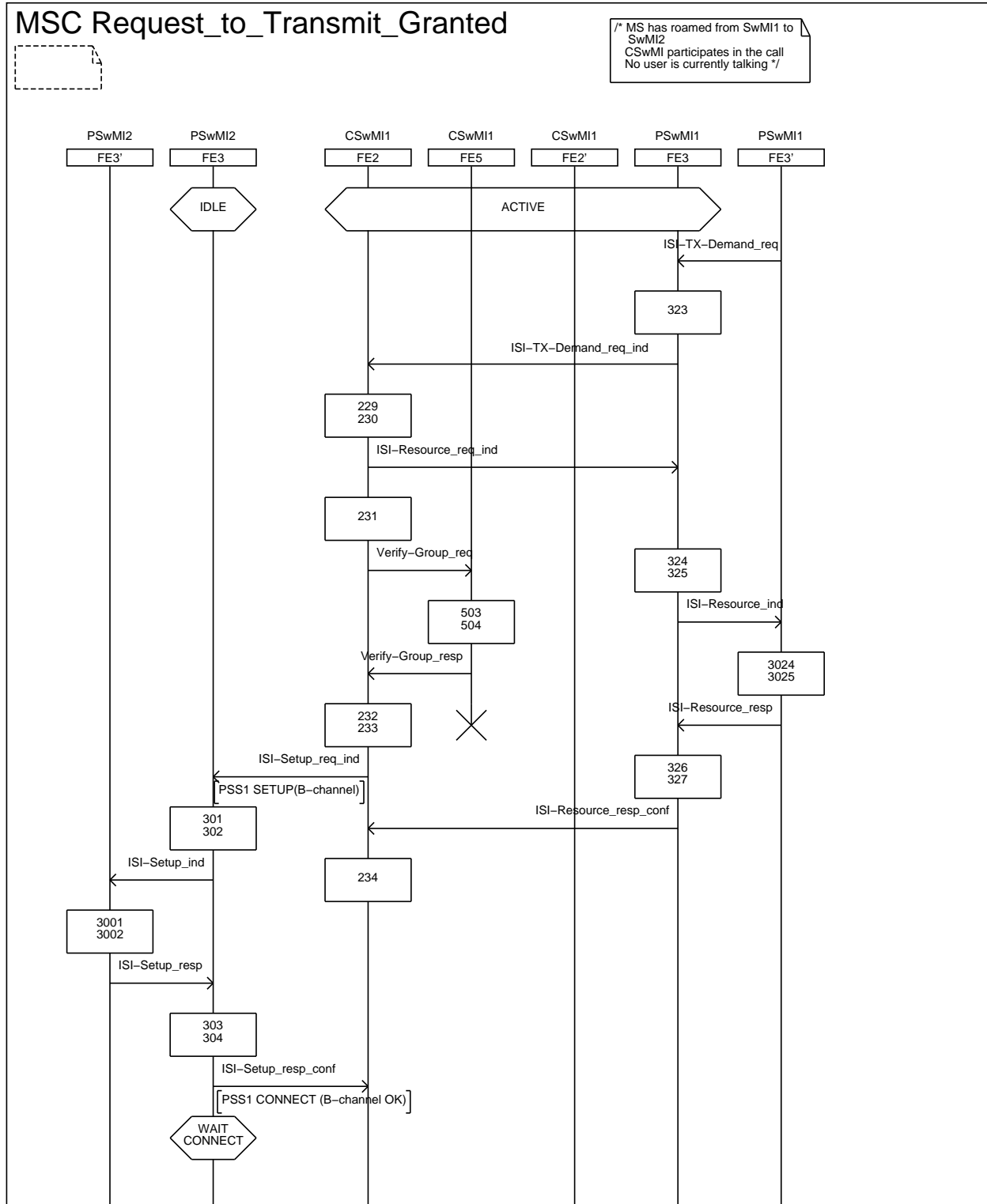


Figure 46: Information flow sequence - Request to transmit from participating SwMI (sheet 1 of 2)

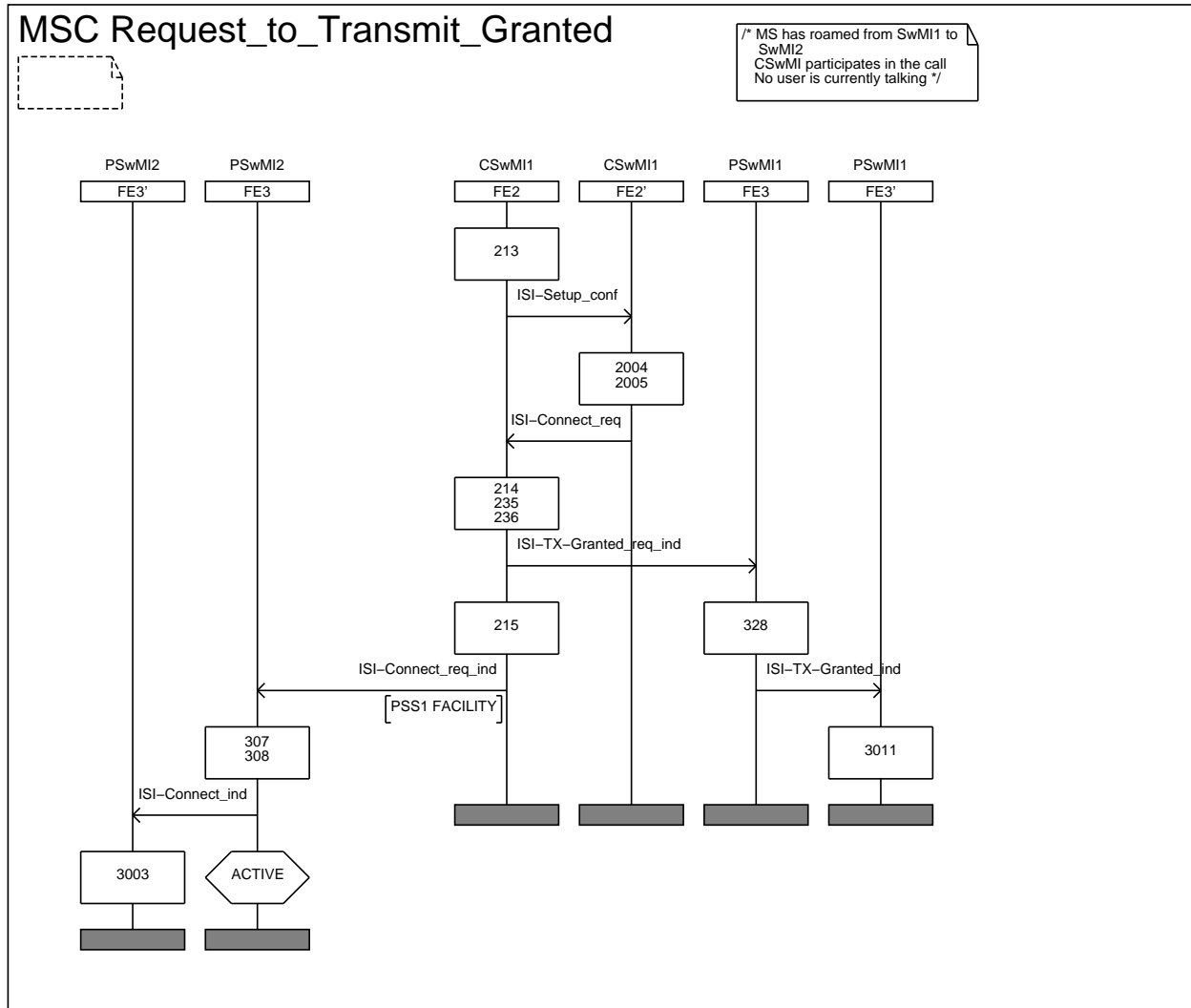


Figure 47: Information flow sequence - Request to transmit from participating SwMI (sheet 2 of 2)



Figure 48 shows the information flow sequence for a request to transmit from a TETRA user in a participating SwMI. The transmission request is queued by the controlling SwMI.

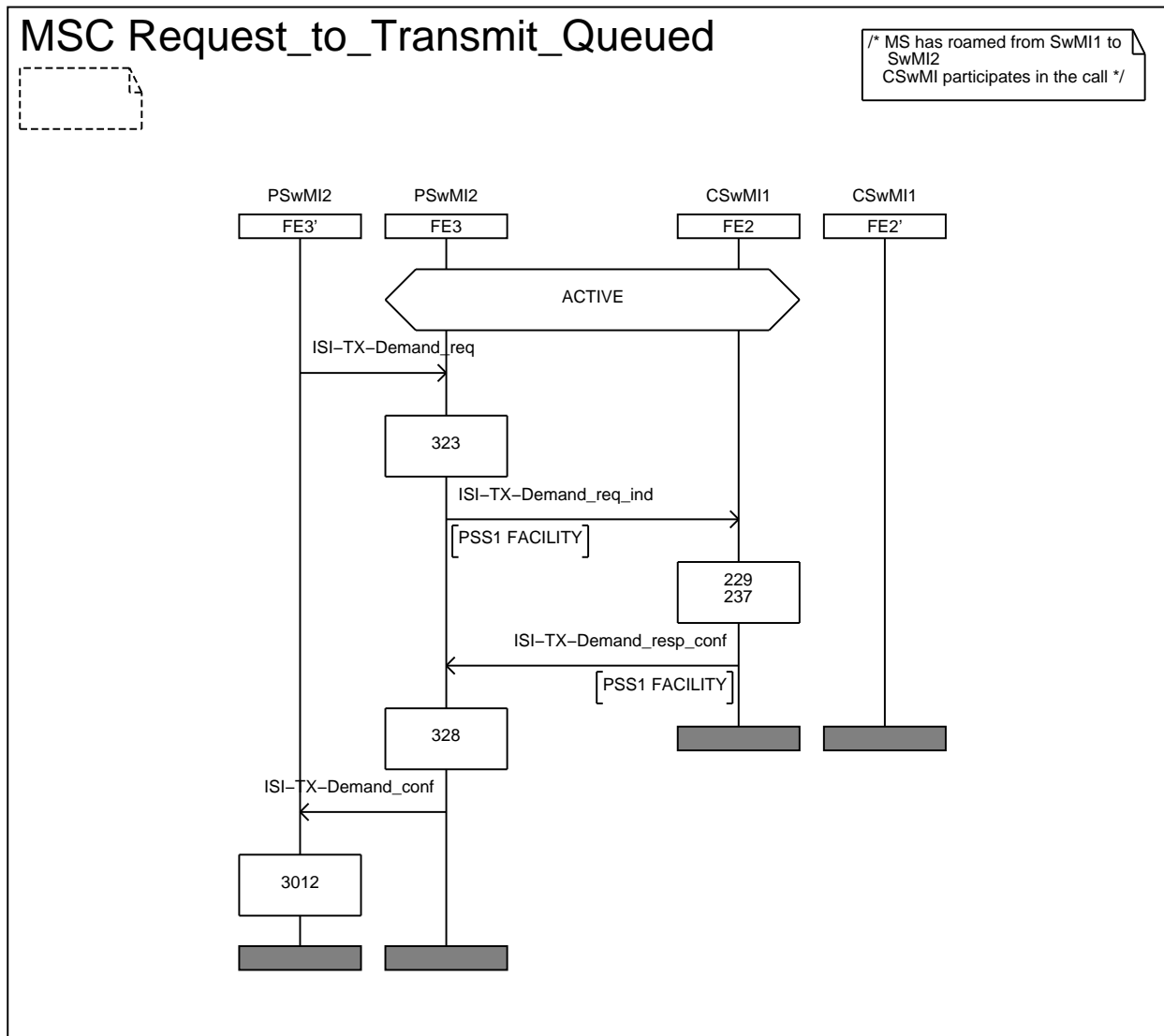


Figure 48: Information flow sequence - Request to transmit queued

Figures 49 to 51 show the information flow sequence for a request to transmit from a TETRA user in a participating SwMI. The transmission request is delayed due to lack of resources.

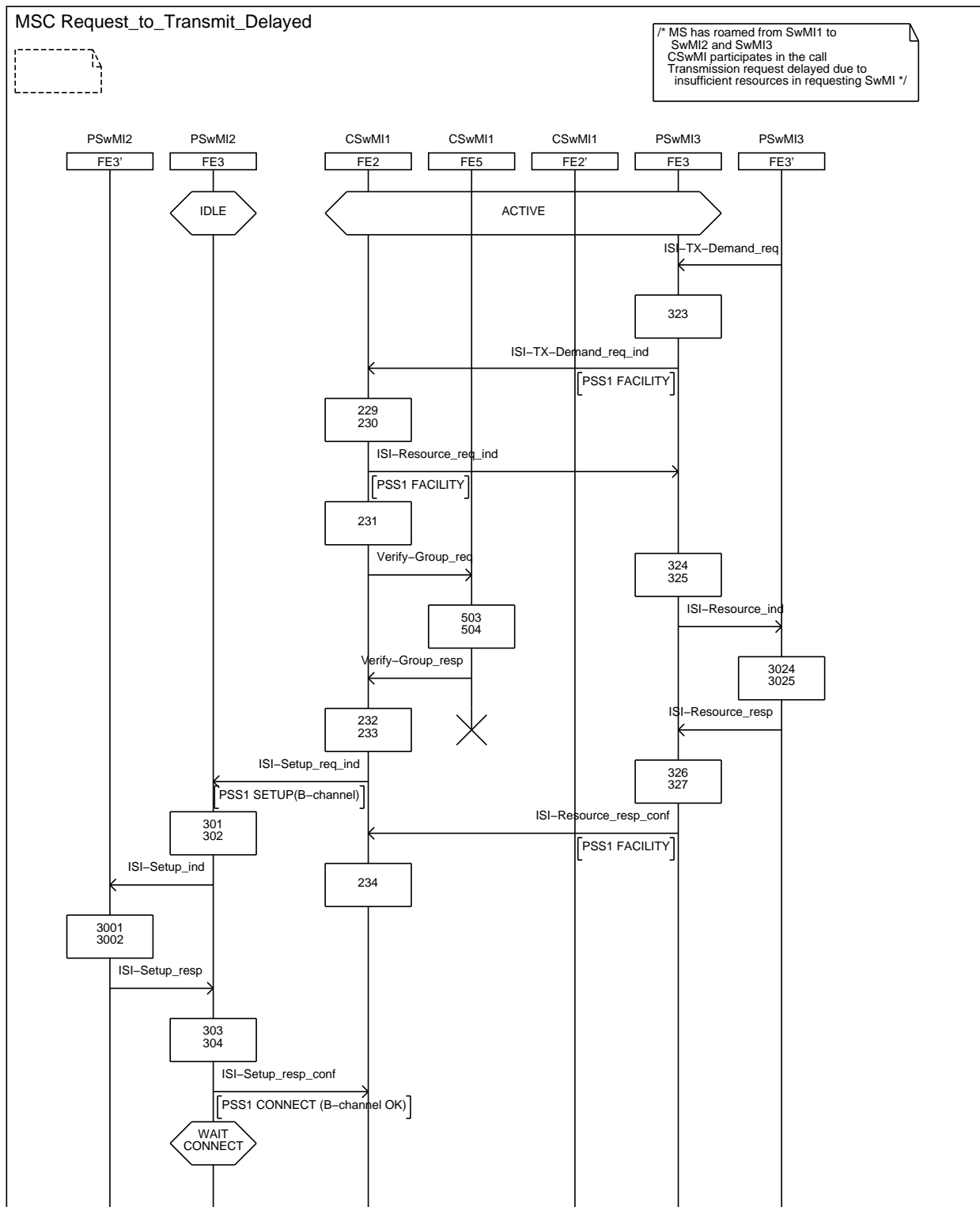


Figure 49: Information flow sequence - Request to transmit delayed (sheet 1 of 3)

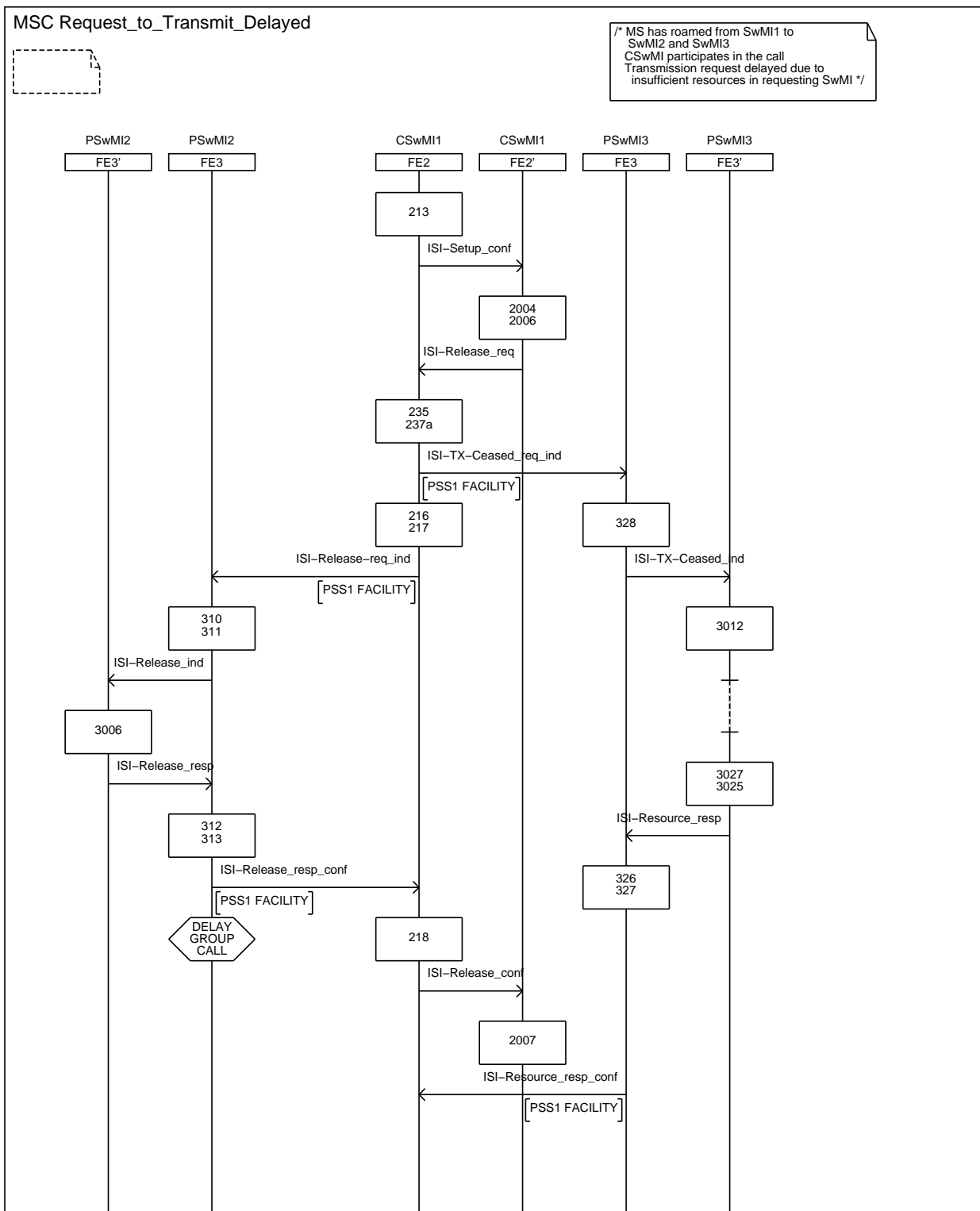


Figure 50: Information flow sequence - Request to transmit delayed (sheet 2 of 3)

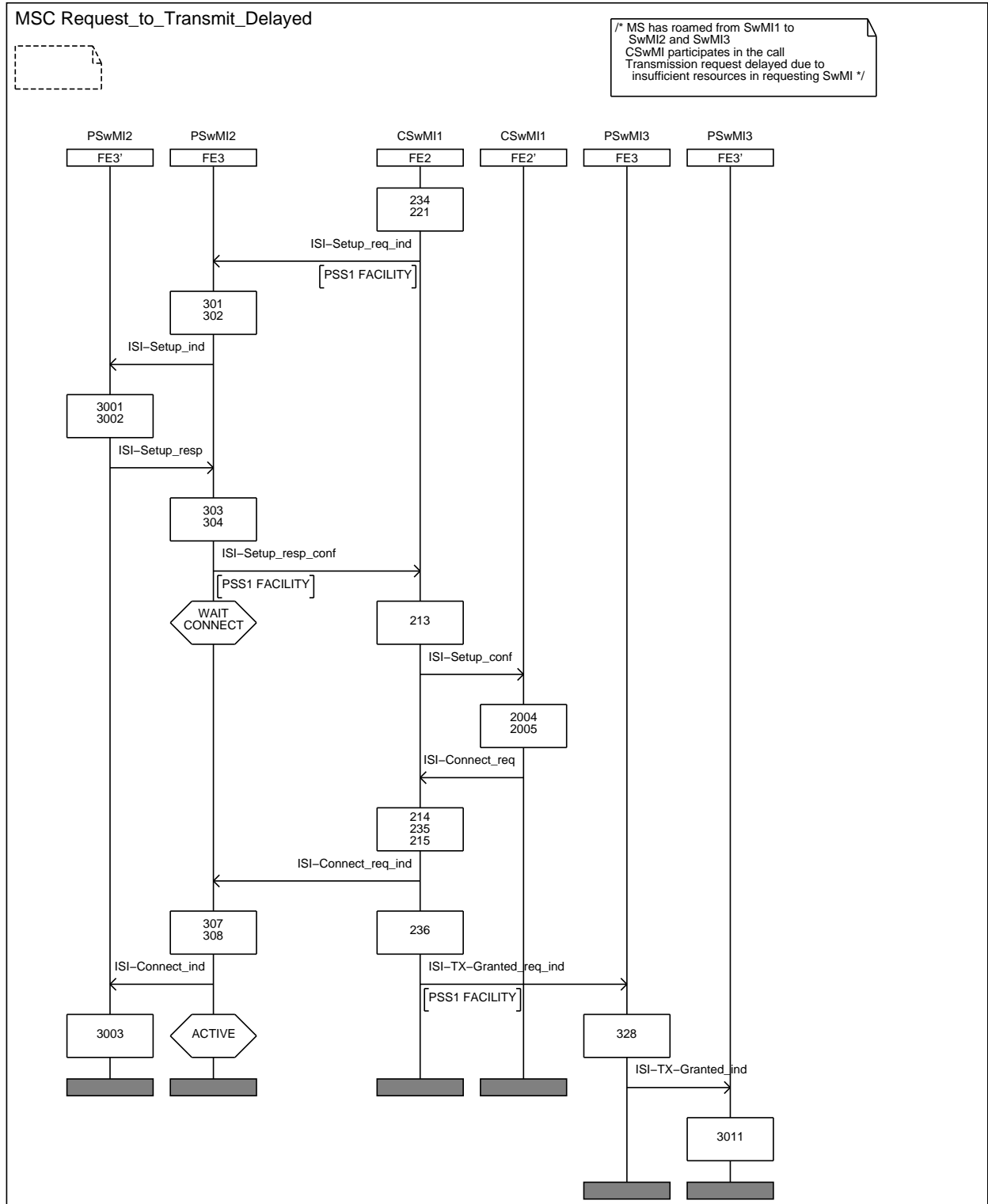


Figure 51: Information flow sequence - Request to transmit delayed (sheet 3 of 3)

Figure 52 shows the information flow sequence for a request to transmit from a TETRA user in a participating SwMI. The transmission request is rejected by the controlling SwMI. No queuing mechanism exists in controlling SwMI.

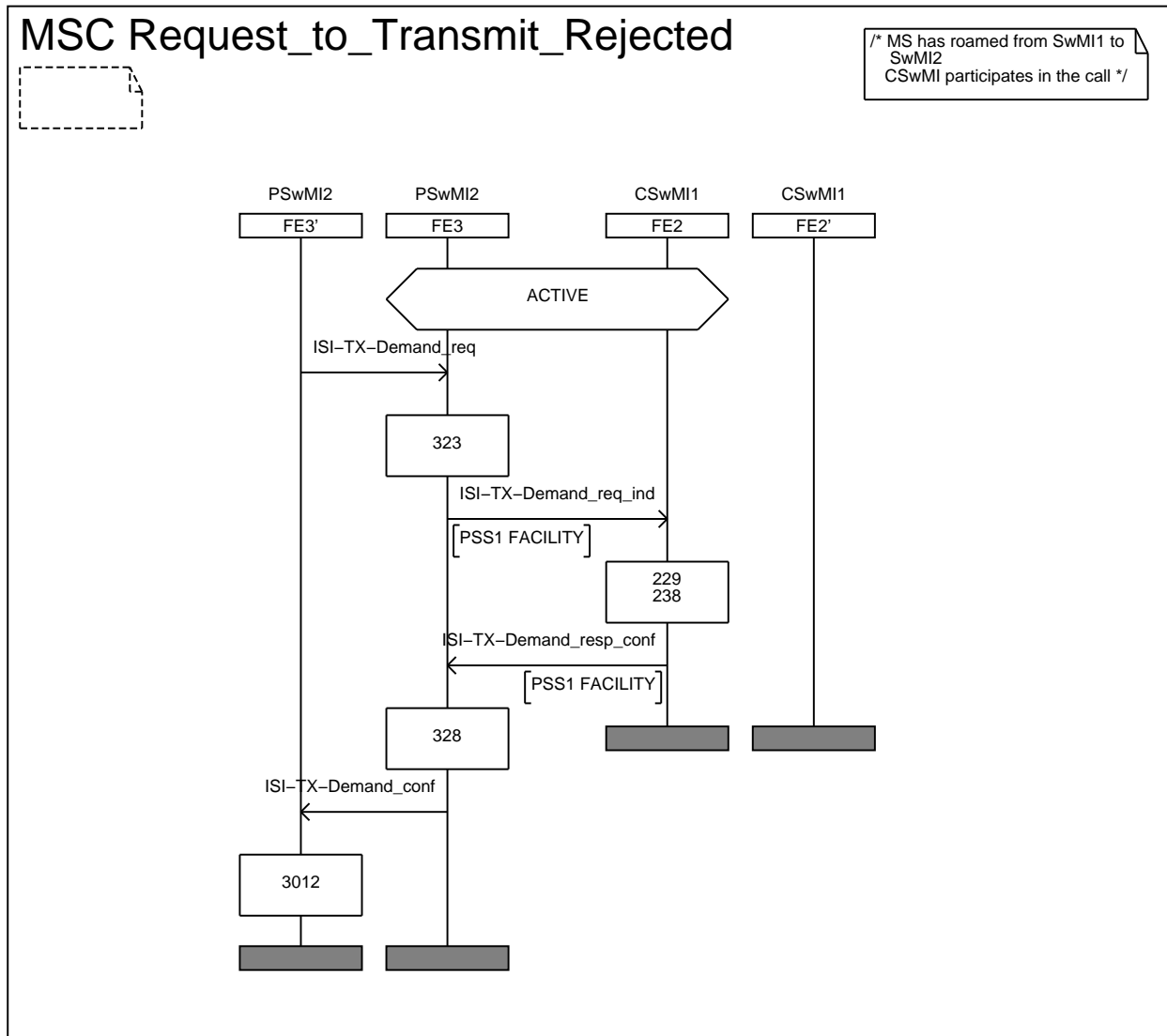
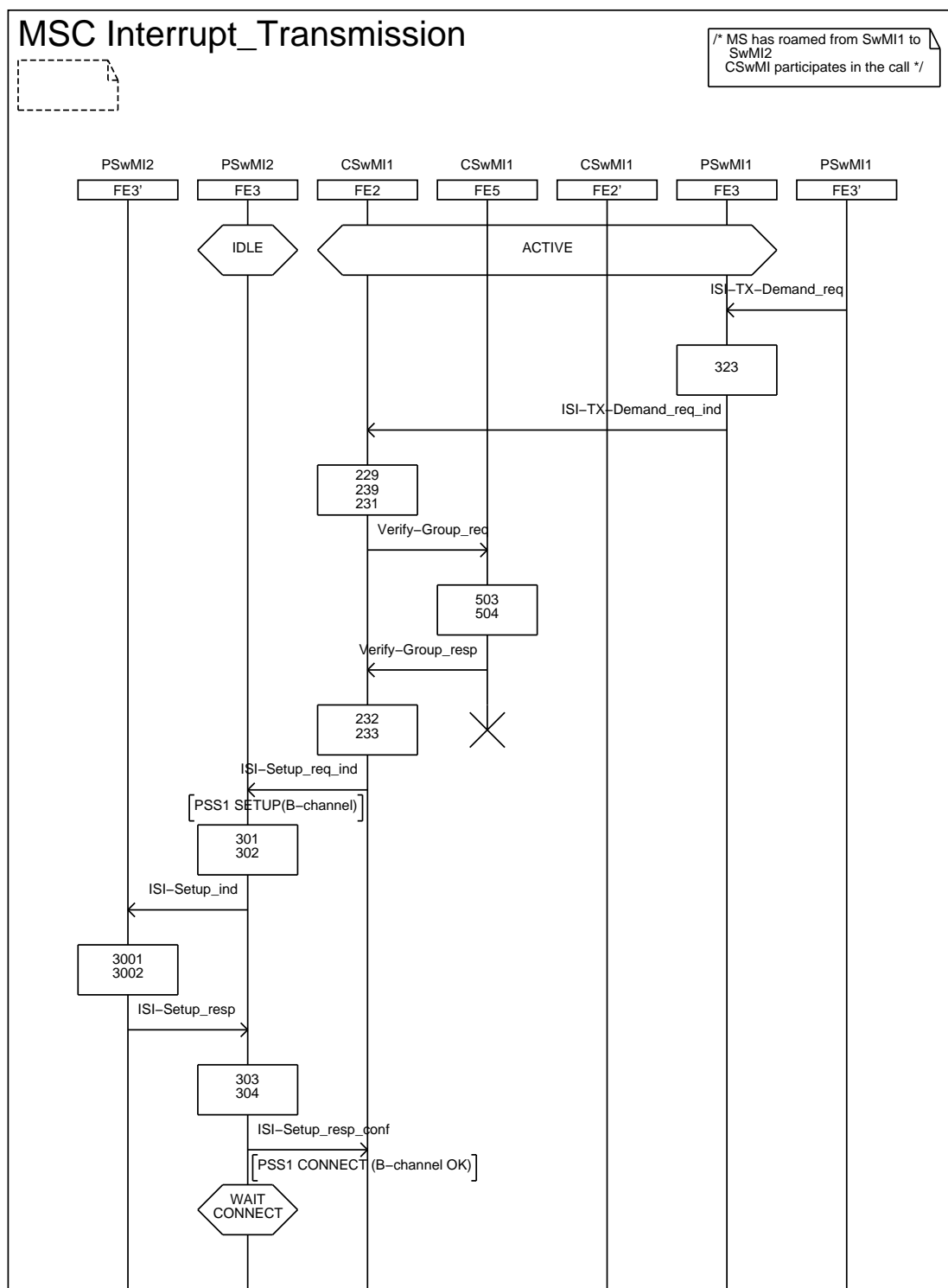


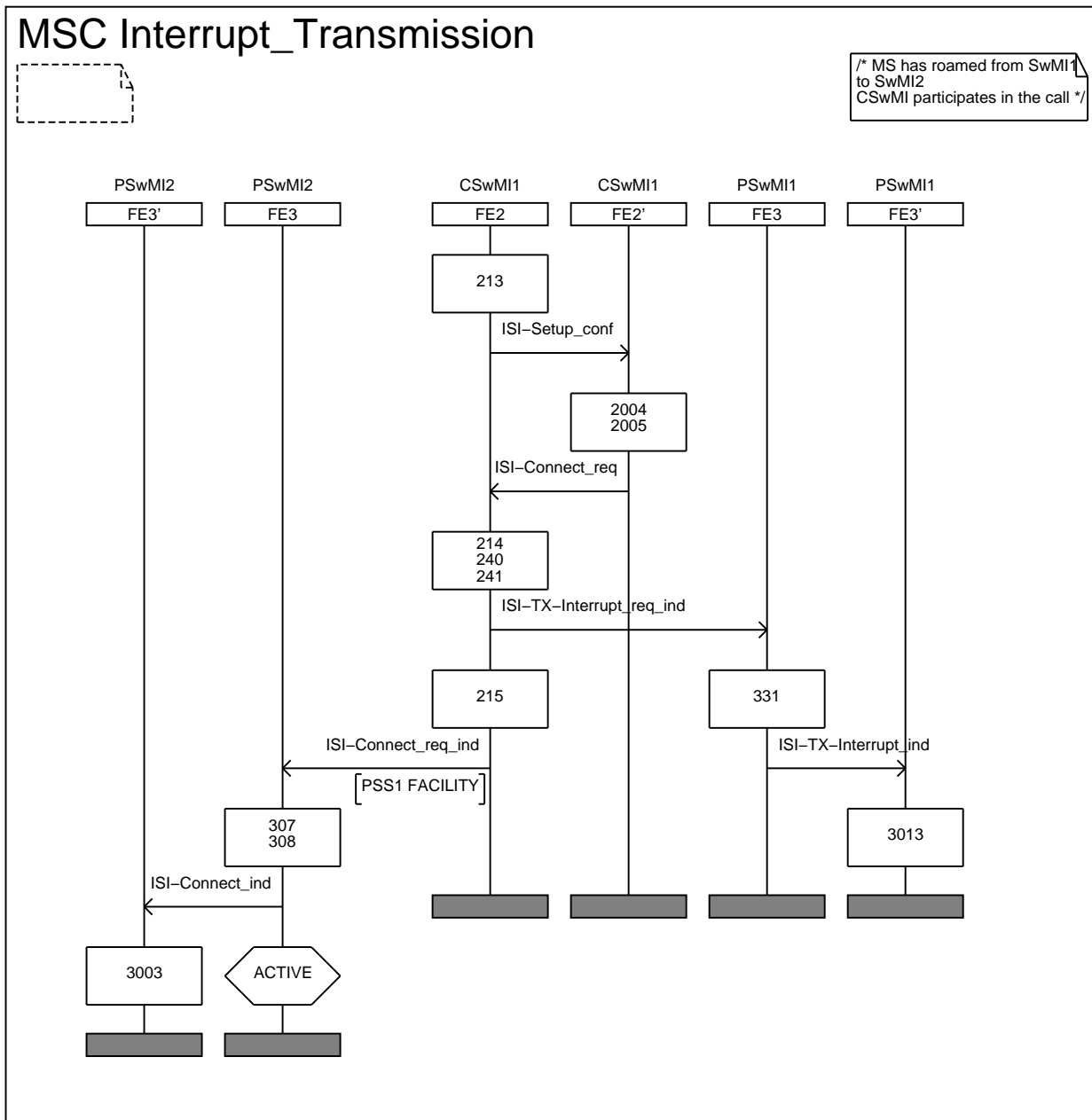
Figure 52: Information flow sequence - Request to transmit rejected

Figures 53 and 54 show the information flow sequence for a pre-emptive request to transmit from a TETRA user in a participating SwMI. Transmission is already granted to another user. The transmitting user is interrupt by an ISI\_TX\_INTERRUPT PDU sent from the controlling SwMI. The ISI\_TX\_INTERRUPT PDU shall be group addressed. The participating SwMI call control application shall upon reception of an ISI\_TX\_INTERRUPT ind. inform the transmitting user of interruption and inform the requesting user of granted transmission.

NOTE: All participating SwMIs who are listening to the call should receive information about the new granted user in a group addressed ISI\_TX\_INTERRUPT PDU as shown in figures 53 and 54.



**Figure 53: Information flow sequence - Request to transmit interrupting current transmission (sheet 1 of 2)**



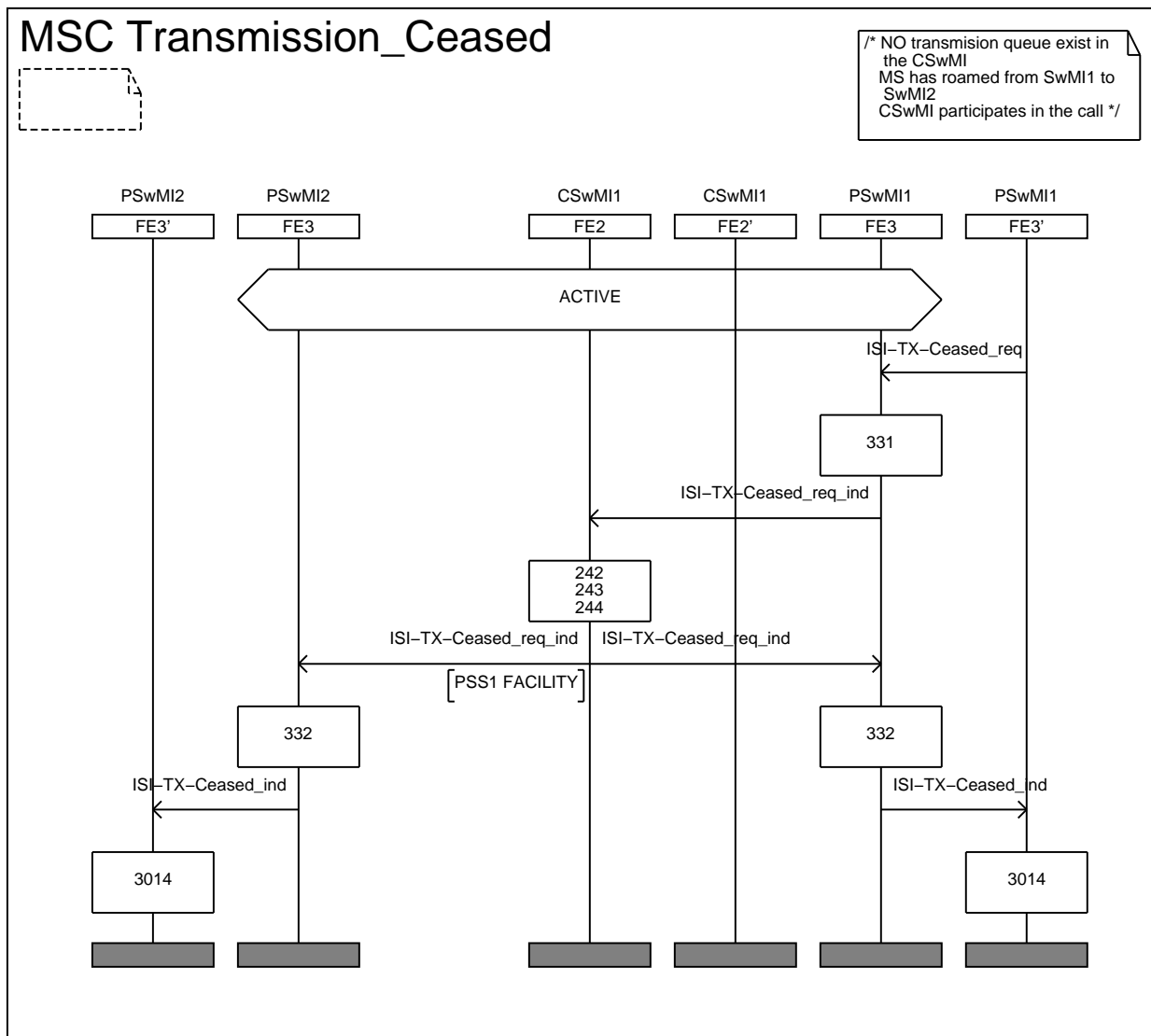
NOTE: If the parameter value, transmission grant in the ISI\_TX\_INTERRUPT PDU, is set to "transmission not granted", then an ISI\_RESOURCE PDU shall be sent to all participating SwMI(s) to check if resources are still available before an ISI\_TX\_GRANTED PDU is sent from the controlling SwMI. See figures 46 and 47 for an ISI\_RESOURCE PDU sequence.

**Figure 54: Information flow sequence -  
Request to transmit interrupting current transmission (sheet 2 of 2)**

5.2.1.8 Call maintenance procedures - Cease transmission

Figures 55 to 58 show the information flow sequence for cease of transmission from a TETRA user in a participating SwMI and the possible responses from the controlling SwMI.

NOTE: All participating SwMIs who are listening to the call should receive information about the cease of transmission with a group addressed ISI\_TX\_CEASED PDU as shown in figure 55.



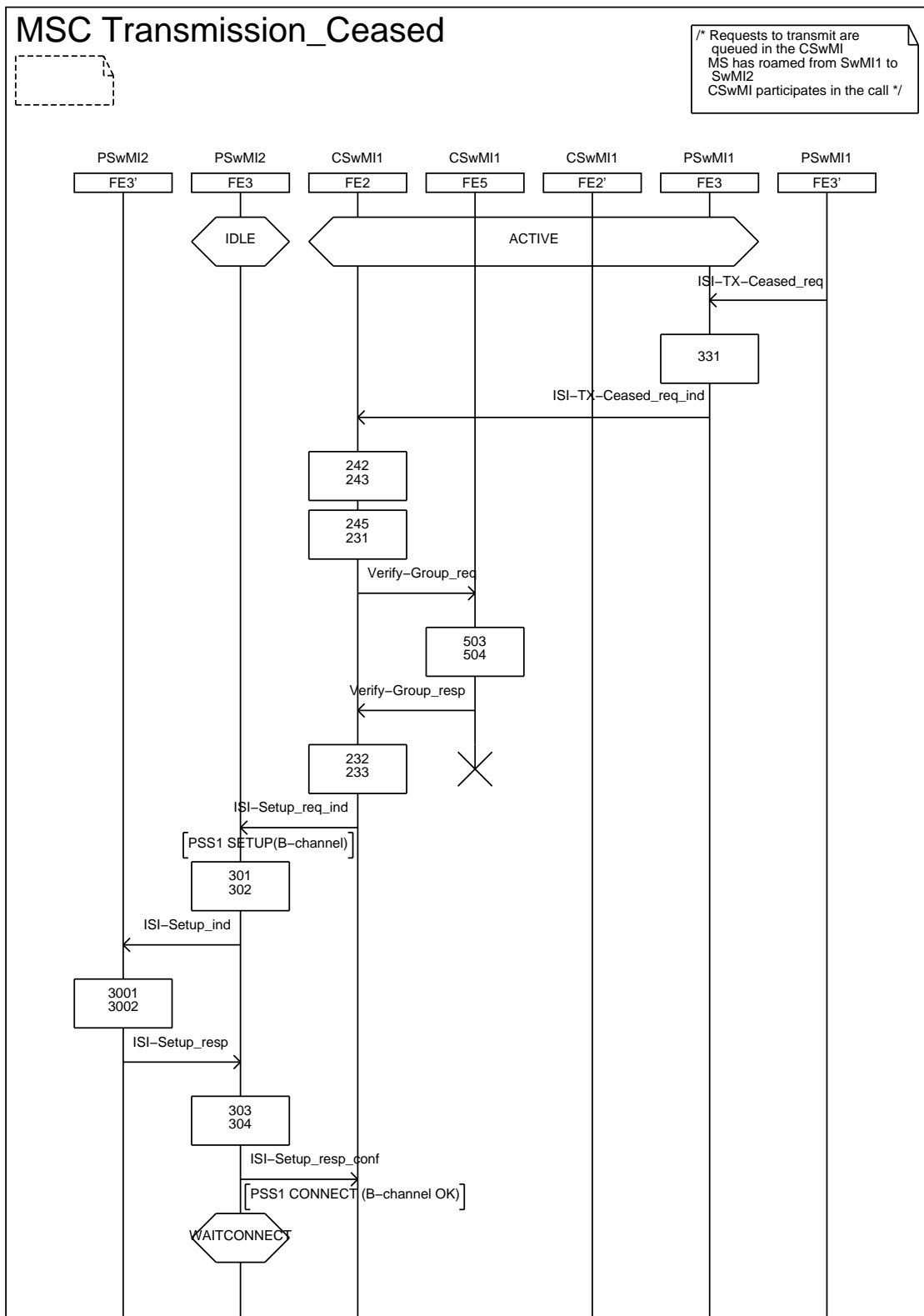
NOTE: No request has been queued by the controlling SwMI.

**Figure 55: Information flow sequence - Request by participating SwMI to cease current transmission**

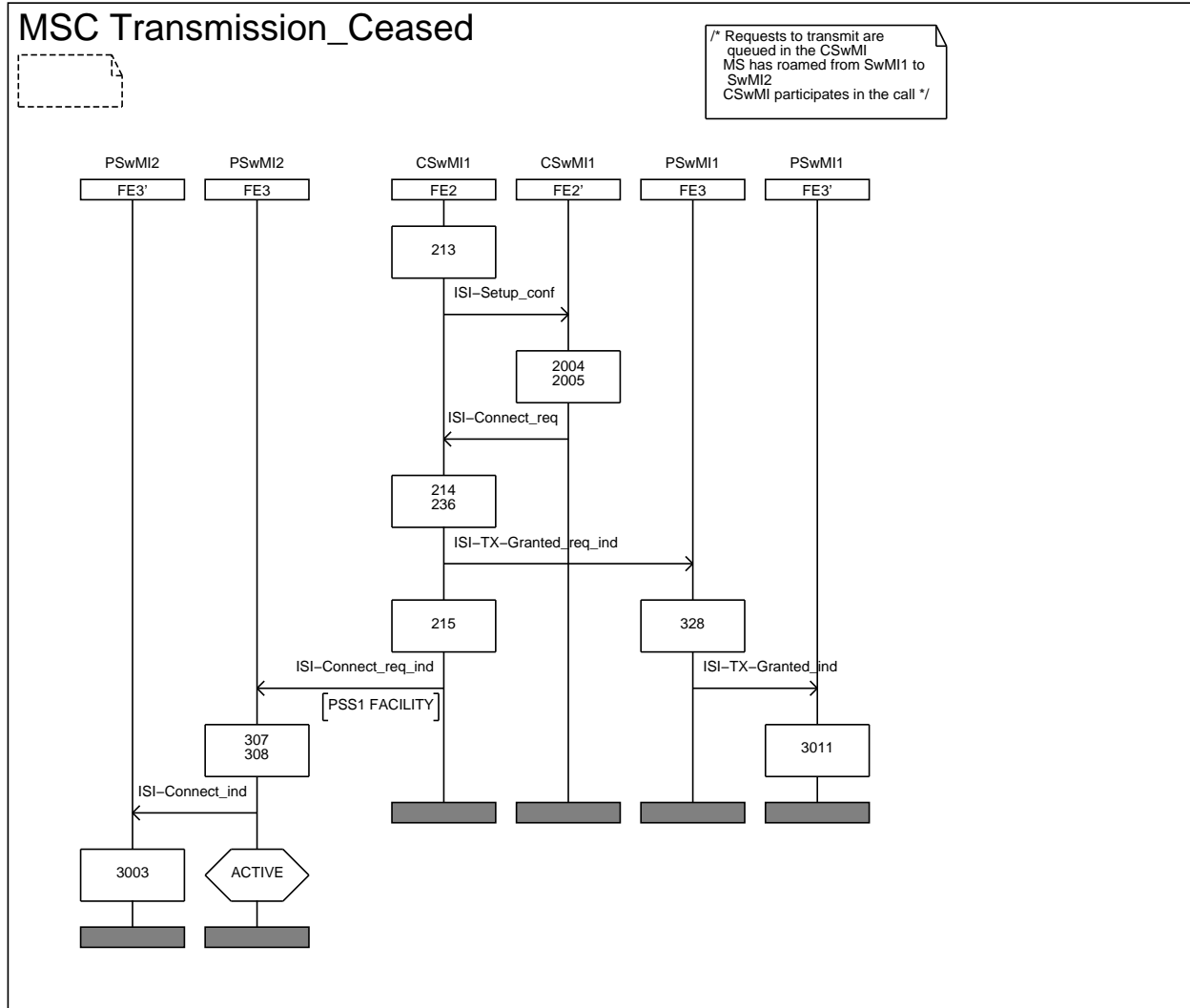


Figures 56 and 57 show the information flow sequence for cease of transmission from a TETRA user in a participating SwMI. Requests to transmit have been queued in the controlling SwMI. Permission to transmit granted to first in queue.

All participating SwMIs who are listening to the call should receive information about the new grant of transmission by a group addressed ISI\_TX\_GRANTED PDU as shown in figures 56 and 57. An ISI\_TX\_CEASED PDU shall not be sent out to the active group.

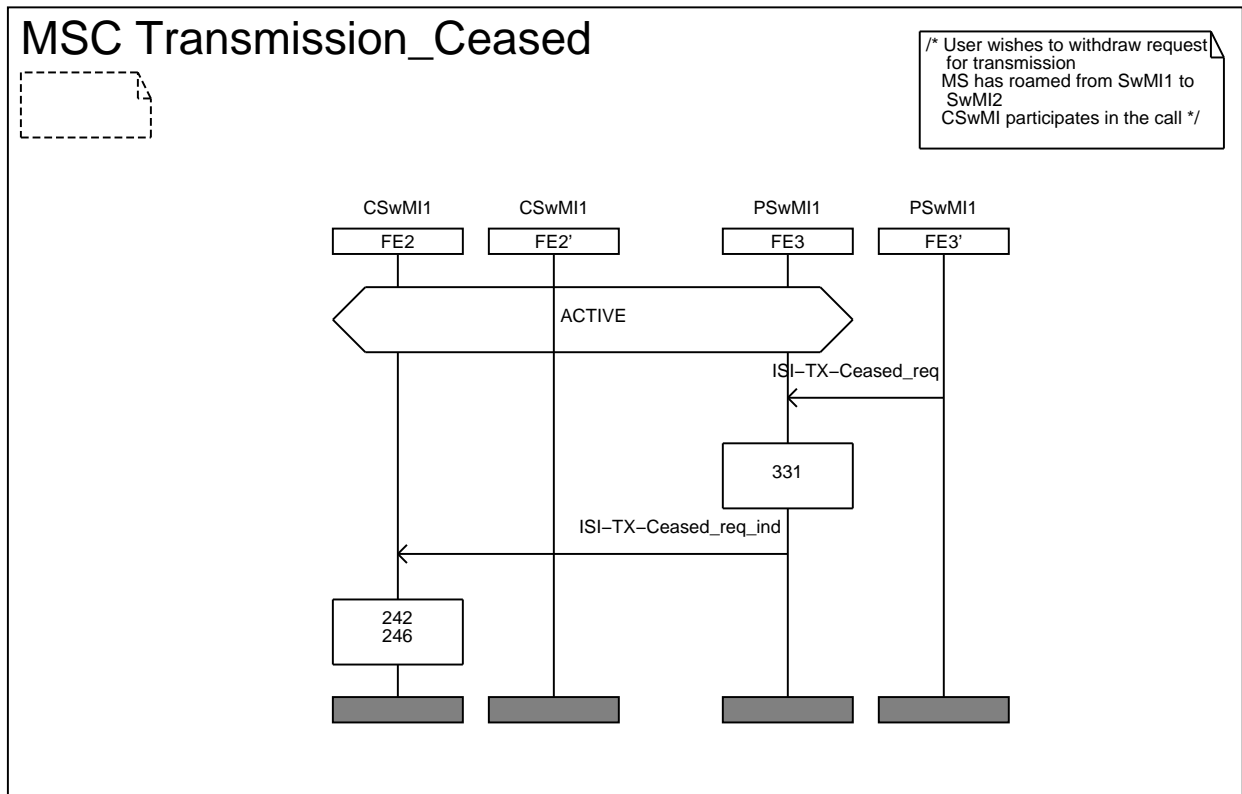


**Figure 56: Information flow sequence - Permission to transmit following a cease transmission sequence (sheet 1 of 2)**



**Figure 57: Information flow sequence -  
 Permission to transmit following a cease transmission sequence (sheet 2 of 2)**

Figure 58 shows the information flow sequence for a request, to withdraw a non-granted transmission request, from a TETRA user in a participating SwMI.

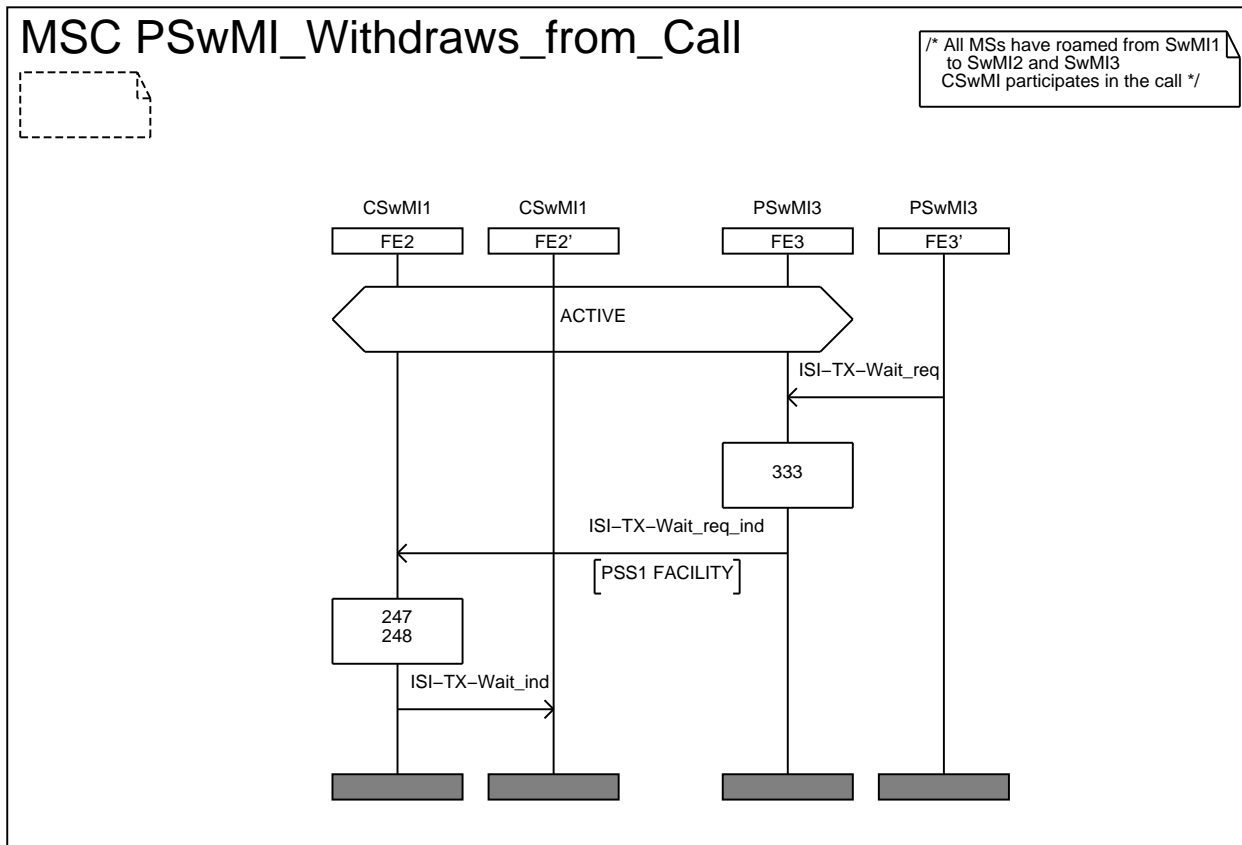


**Figure 58: Information flow sequence - Request by participating SwMI to withdraw a transmission request**

### 5.2.1.9 Call Maintenance procedures - Withdraw/Continue from an active group call

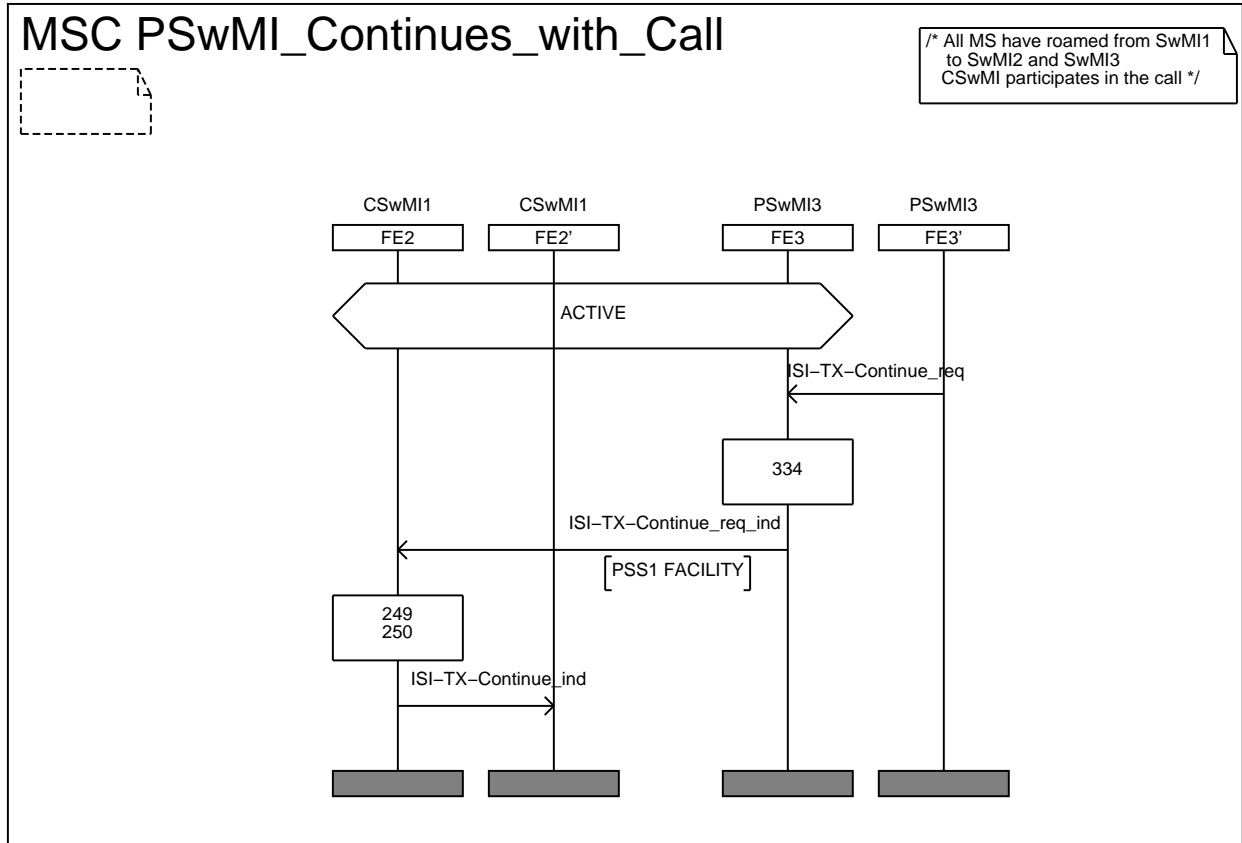
Figures 59 to 60 show the information flow sequence for a request, sent from a participating SwMI, to withdraw or continue from an active group call.

A participating SwMI may decide to interrupt transmission when resources are required for another call or when the SwMI requires that the call should temporarily pause. The controlling SwMI shall be informed of withdrawal.



**Figure 59: Information flow sequence - Request by participating SwMI to withdraw from the active call**

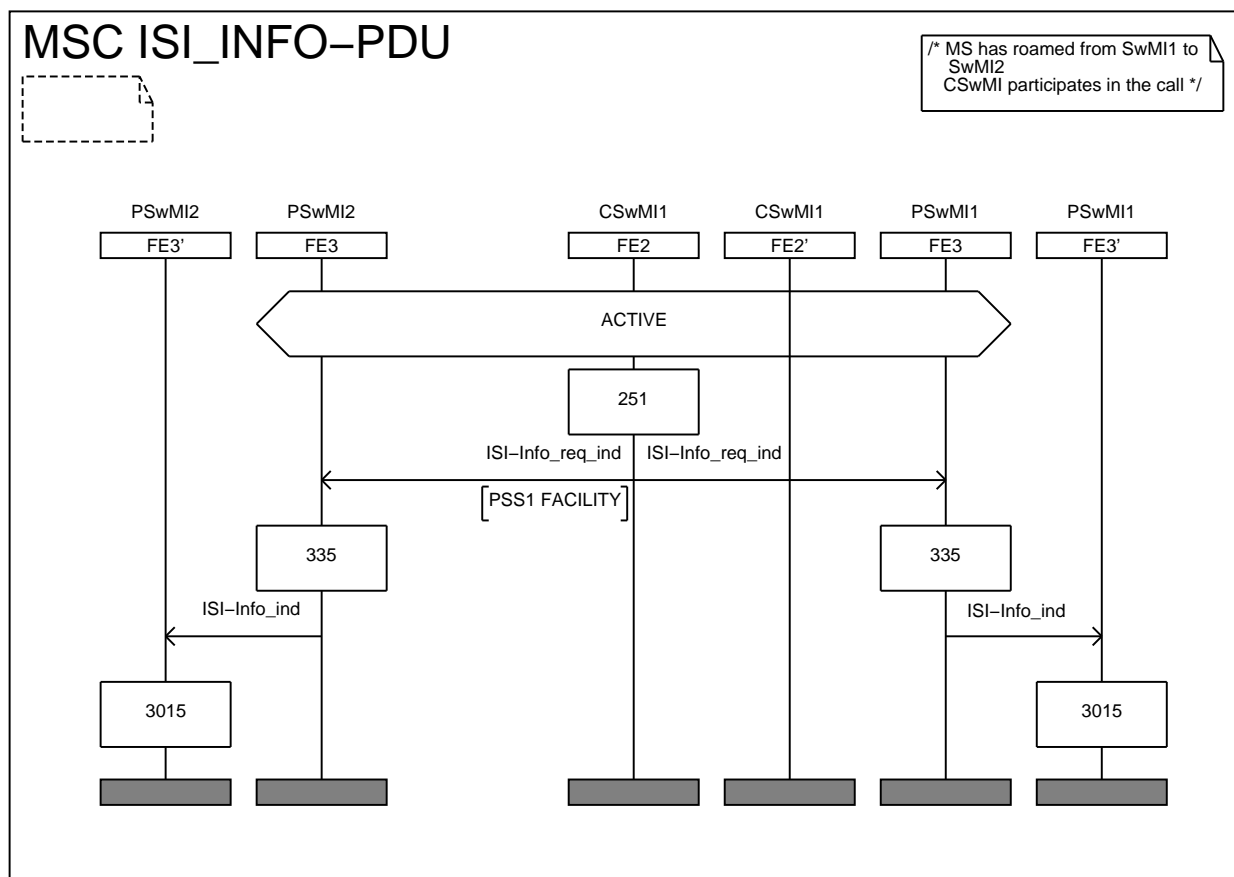
When a withdrawn SwMI wishes to continue with an active call an ISI\_TX\_CONTINUE PDU should be sent to the controlling SwMI. If a user located in the withdrawn SwMI was transmitting at the time of withdrawal, permission to transmit shall not automatically be given to this user upon continuation in the active call. Users located in the withdrawn participating SwMI may request permission to transmit. However, if a queuing mechanism is not implemented in the controlling SwMI for transmission control, all transmission request sent from a withdrawn SwMI shall be rejected.



**Figure 60: Information flow sequence -  
Request by participating SwMI to continue with the active call**

### 5.2.1.10 Call Maintenance procedures - Information flow to participating SwMI(s)

The controlling and participating SwMI(s) may at any time during the maintenance phase of the group call send extra information to one another. The information shall be contained within the information flow ISI\_INFO req.ind.



**Figure 61: Information flow sequence - Information flow sent by the controlling SwMI**

### 5.2.1.11 Call Maintenance procedures - Group call restoration over ISI using ANF-ISIGC

Figures 62 to 66 show the information flow sequence for call restoration. The text and figures cover the three cases described in clause 4.2.2.3.7 plus the following two cases:

- Case 4; a linking controlling SwMI exist and the migrating users home SwMI does not coincide with the linking controlling SwMI. This case also applies when the migrated user is participating in a group call to which he is not a member;
- Case 5 the call already exists at the participating SwMI when call restoration is requested by the migrated user.

For the **case 1 scenario** the user has migrated to a new FE3 where the group call does not exist. The call control application determines that the group call is to be extended to the new SwMI upon transmission granting before the user request for call restoration. The same information flows as shown in figures 46 and 47 apply.

For the **case 2 scenario** the user has migrated to a new FE3 where the group call does not already exist. The group call is extended over ISI upon call restoration request from the migrated user. Figures 62 and 63 show the interaction between the new FE3 and FE2.

For the **case 3 scenario** the user has migrated to a new FE3. The user was the last group member attached to the old FE3. Figure 64 shows how the group call and ISI-path is released from the old FE3.

For the **case 4 scenario** the user has migrated to a new FE3 where the group call does not already exist. The migrated MS has no knowledge of group linking and therefore does not send the call restoration request to the linking controlling SwMI. The new FE3 is told to re-route the call restoration request. Figure 65 shows call restoration with re-routing.

For the **case 5 scenario** the call already existed at the new participating SwMI, the controlling SwMI shall send an ISI-CALL RESTORATION resp.conf. to the participating SwMI without initiating the call set-up sequence. Figure 66 shows how this is performed.

NOTE: When a call restoration request cannot be accepted by the controlling SwMI, an ISI-CALL RESTORATION reject response will be returned to the participating SwMI.

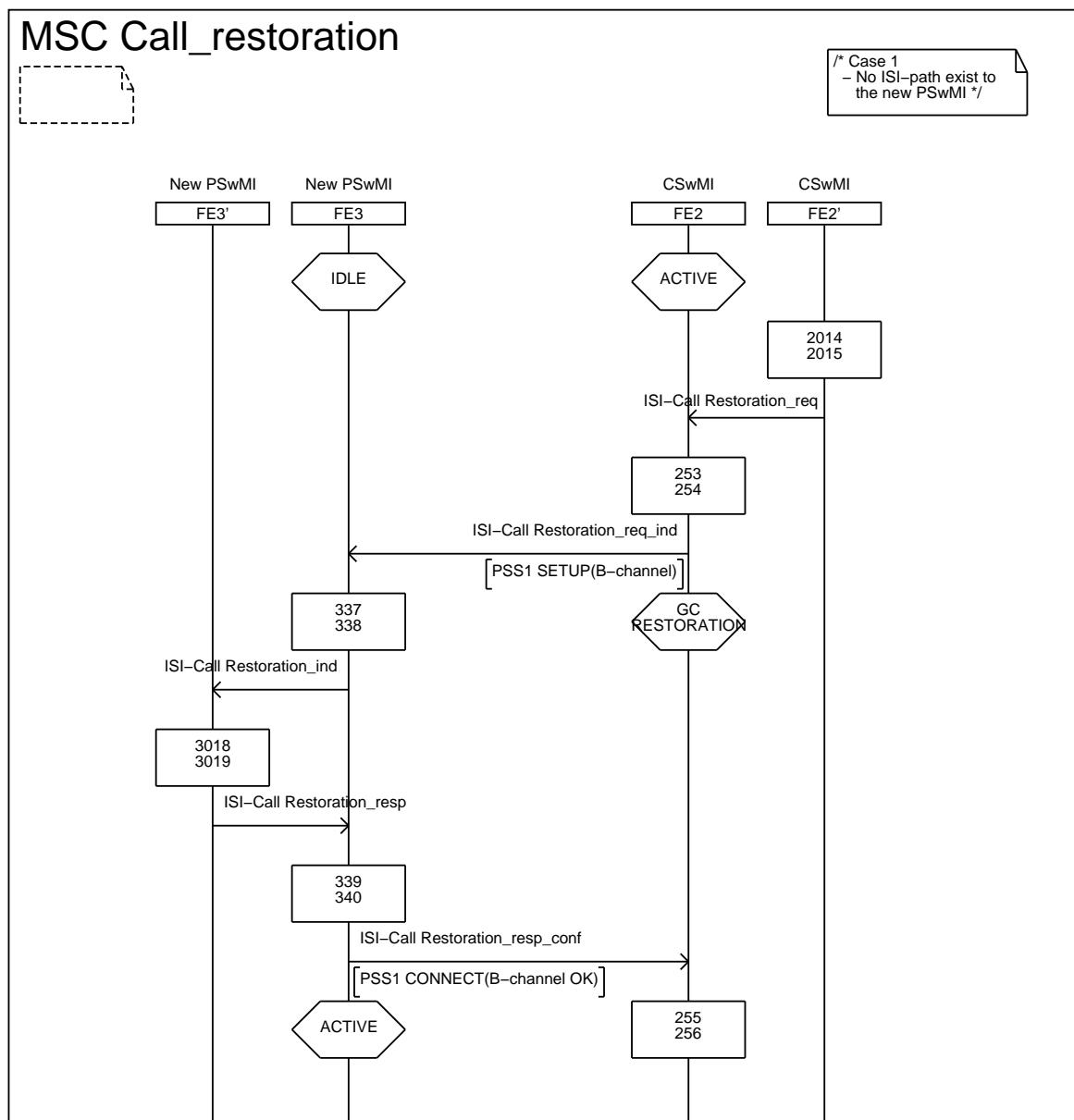


Figure 62: Information flow sequence - Group call restoration, case 2 (sheet 1 of 2)

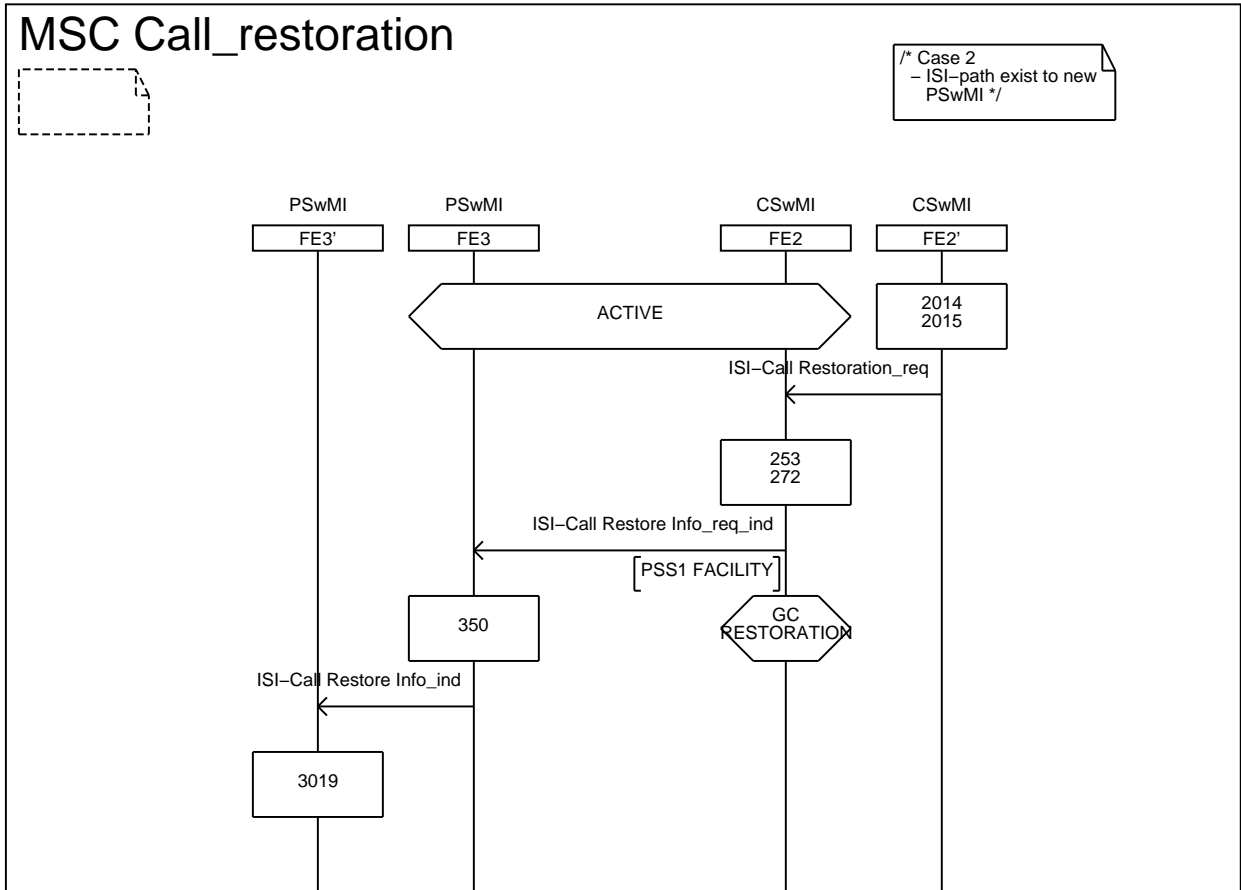


Figure 63: Information flow sequence - Group call restoration, case 2 (sheet 2 of 2)



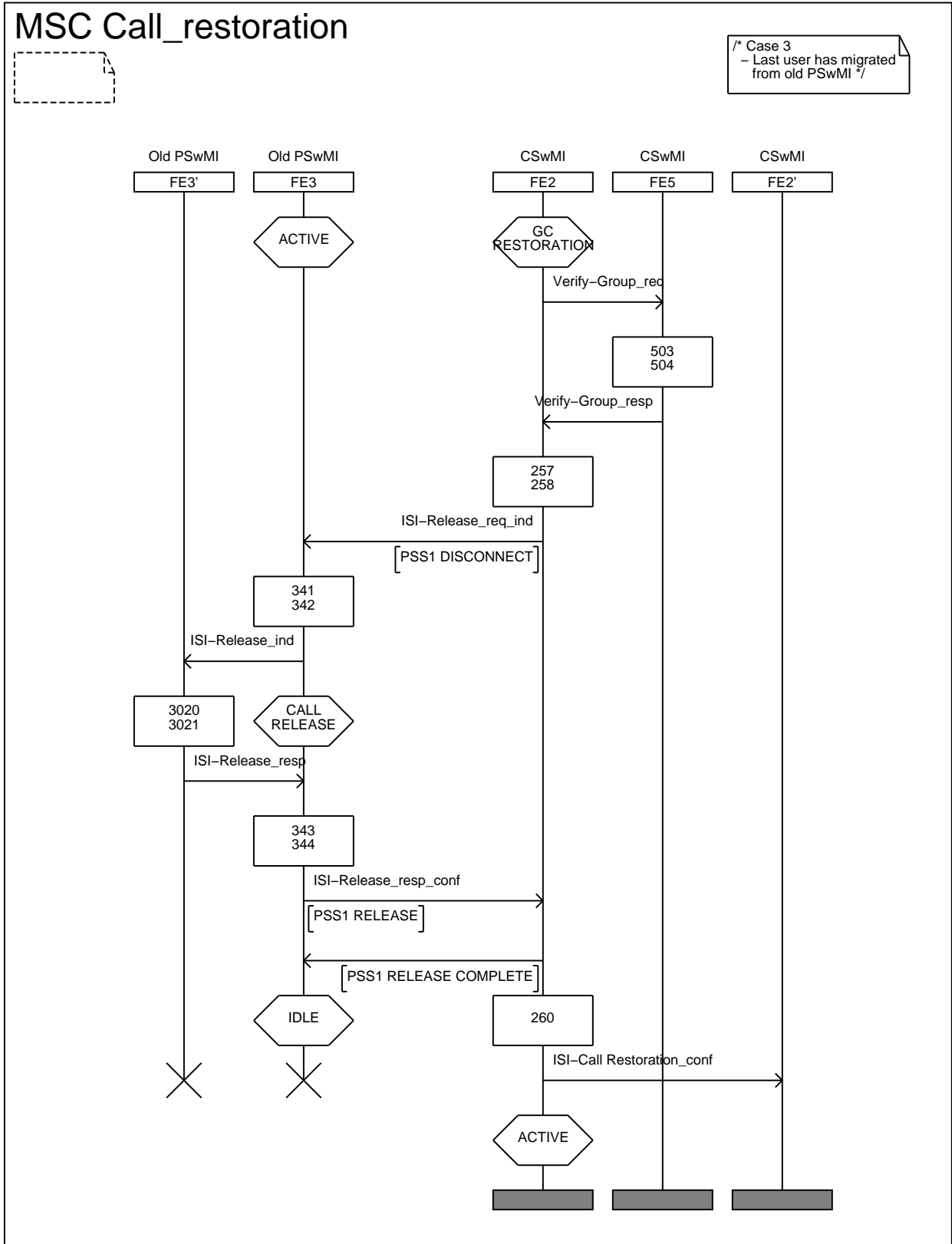


Figure 64: Information flow sequence - Group call restoration, case 3

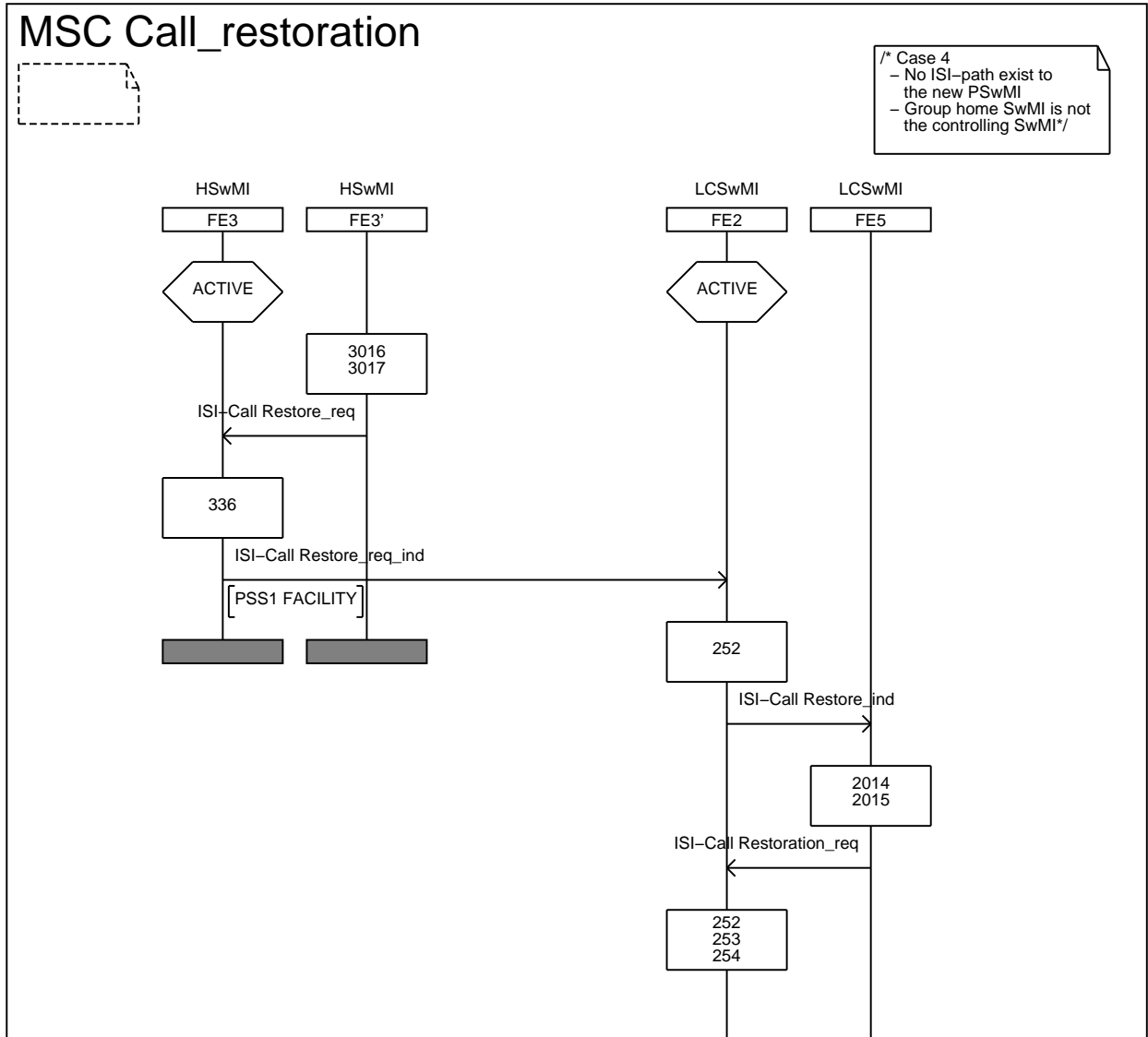


Figure 65: Information flow sequence - Group call restoration, case 4

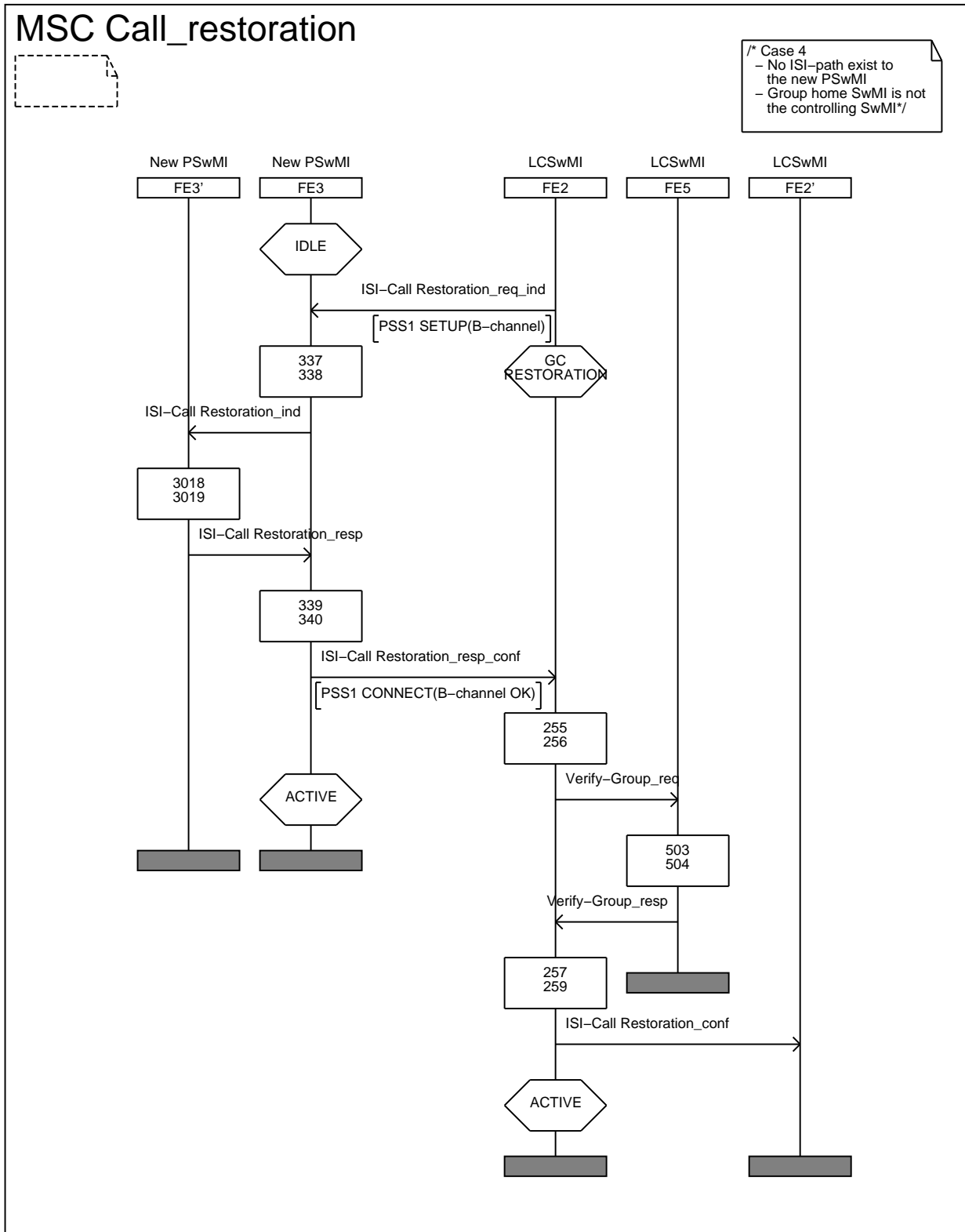


Figure 66: Information flow sequence - Group call restoration, case 5

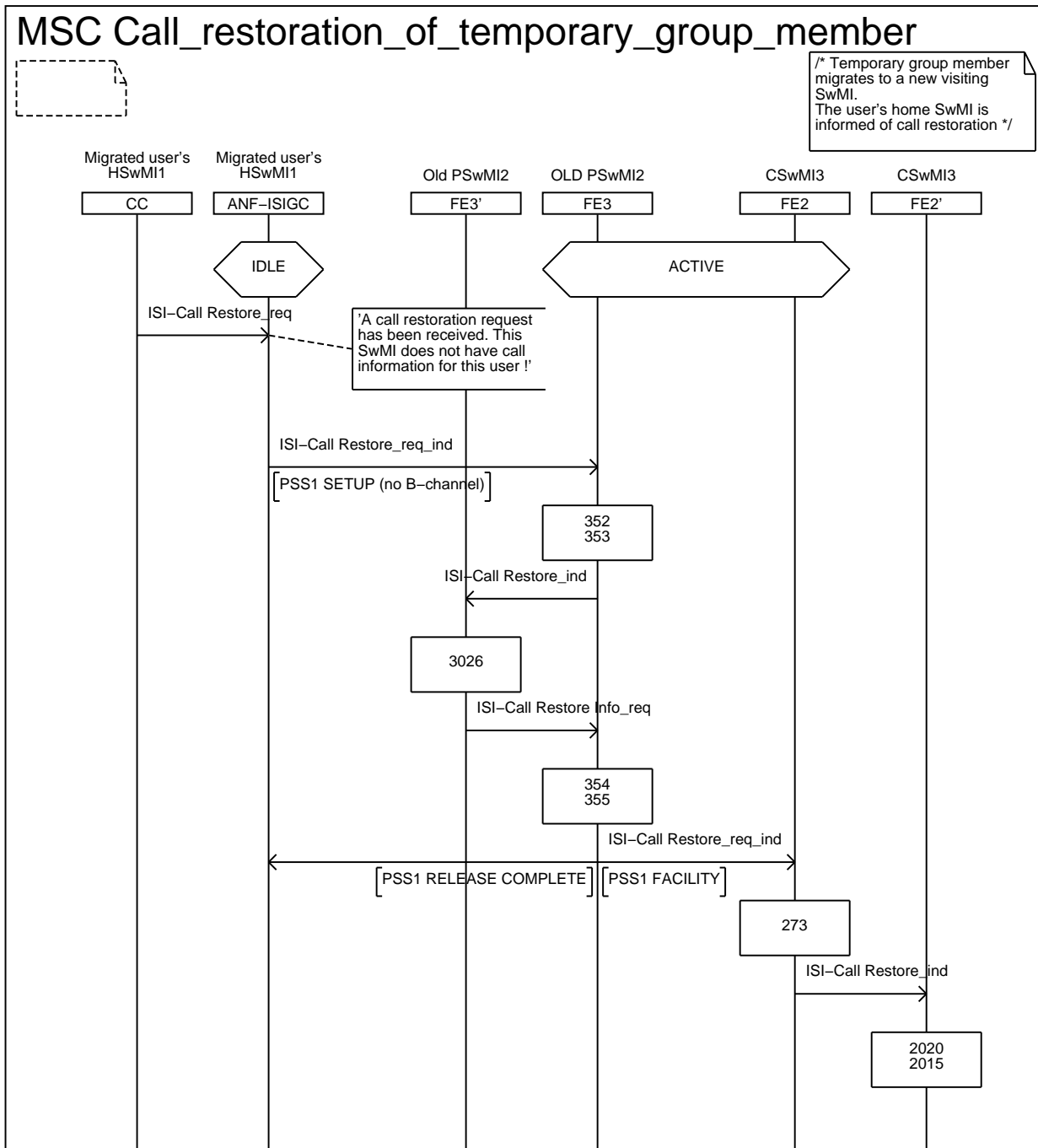


Figure 66a

### 5.2.1.12 Call Disconnection procedures - Controlling SwMI disconnects the call

Figure 67 shows the information flow sequence for disconnection of a group call initiated by the controlling SwMI. When a controlling SwMI disconnects a group call the entire group call shall be disconnected, i.e. all SwMIs involved in the call shall disconnect the call.

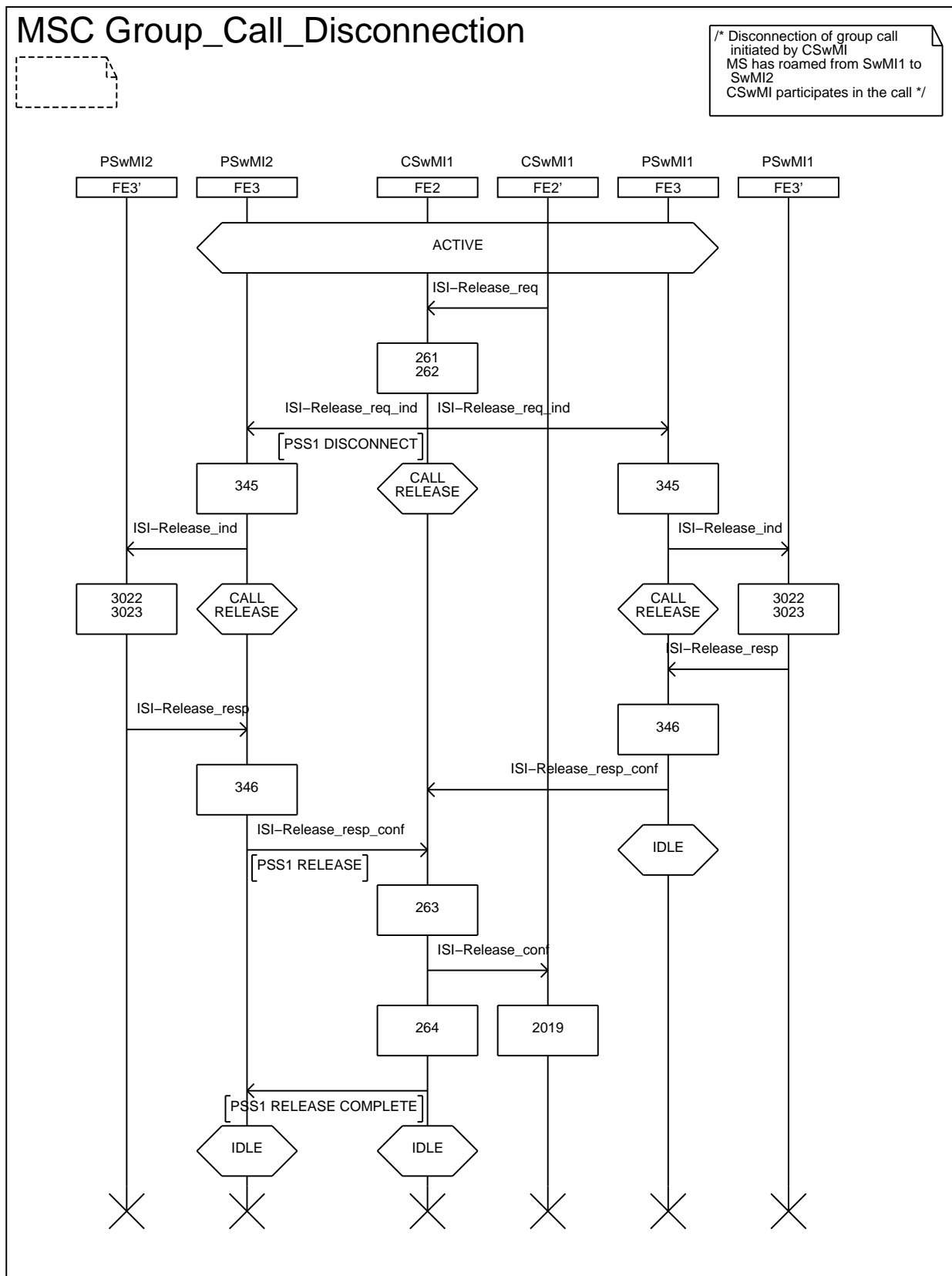


Figure 67: Information flow sequence - Group call disconnection by controlling SwMI

5.2.1.13 Call Disconnection procedures - Participating SwMI disconnects from the call

Figures 68 and 69 show the information flow sequence for partial disconnection of a group call initiated by a participating SwMI. When a participating SwMI wishes to disconnect from a group call, the controlling SwMI shall be informed. The controlling SwMI shall always evaluate if the group call shall continue or if the call is to be released. If the controlling SwMI chooses not to release the call, the group call shall continue without the disconnected SwMI.

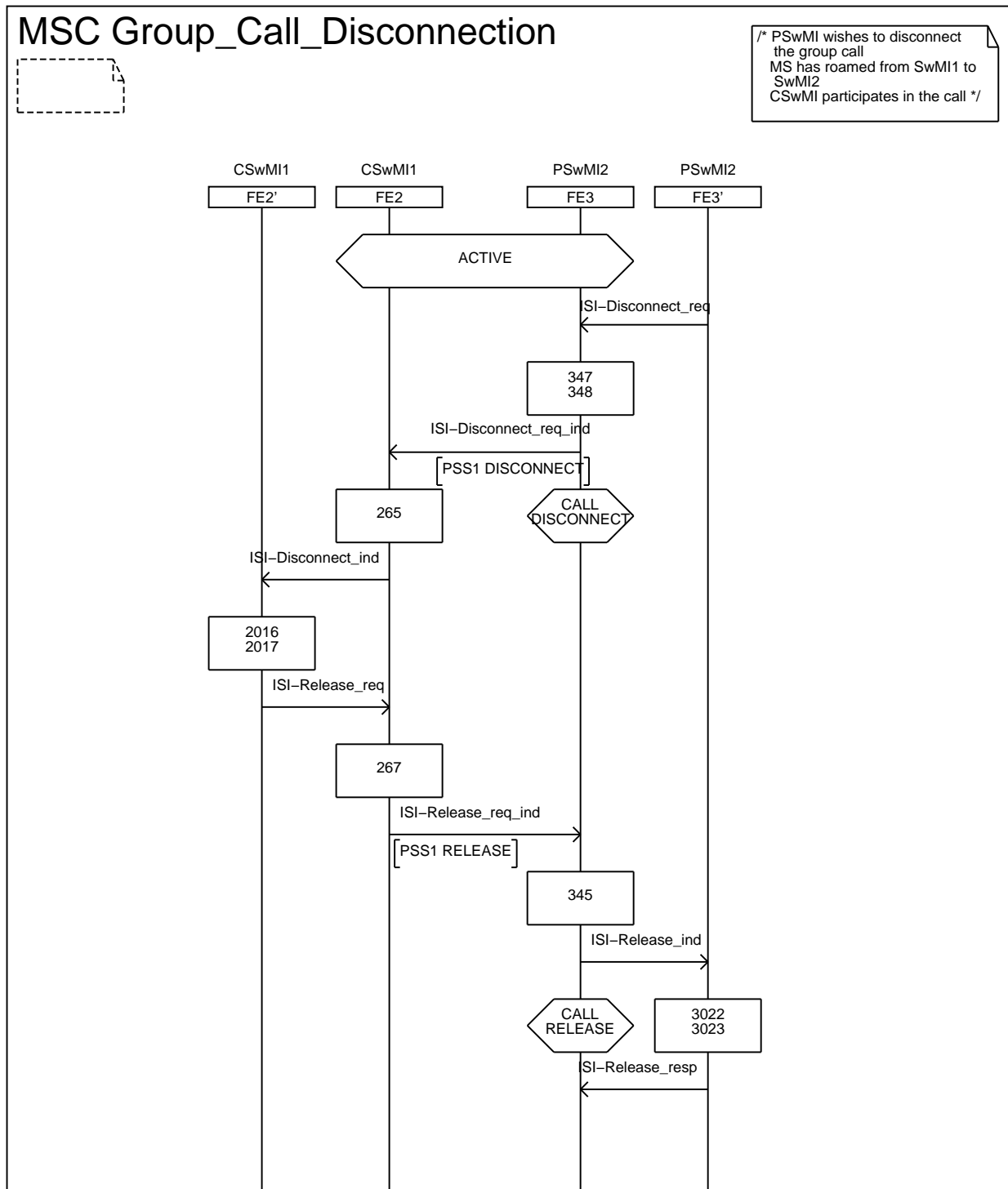
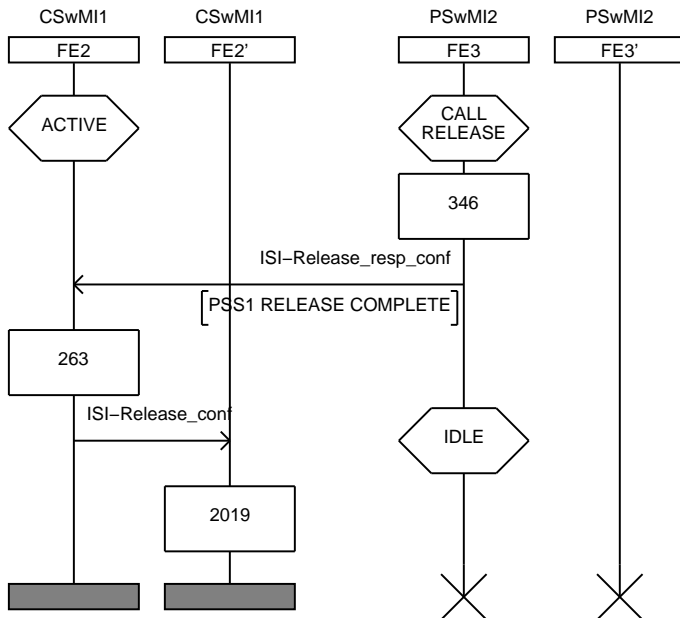


Figure 68: Information flow sequence - Partial Group call disconnection (sheet 1 of 2)

# MSC Group\_Call\_Disconnection



/\* PSwMI wishes to disconnect the group call  
MS has roamed from SwMI1 to SwMI2  
CSwMI participates in the call \*/



NOTE: If required, FE3 may acquire additional information from FE5 when disconnecting.

**Figure 69: Information flow sequence - Partial Group call disconnection (sheet 2 of 2)**

5.2.1.14 Call Disconnection procedures - Call Owner disconnects the whole call

Figures 70 and 71 show the information flow sequence for disconnection of a group call, initiated by the call owner, when the call owner is located in a participating SwMI. When the call owner wishes to disconnect a group call the controlling SwMI shall always release the whole group call. The controlling SwMI shall always be informed of a disconnection request, regardless of whether the disconnection request has been initiated by the call owner or not.

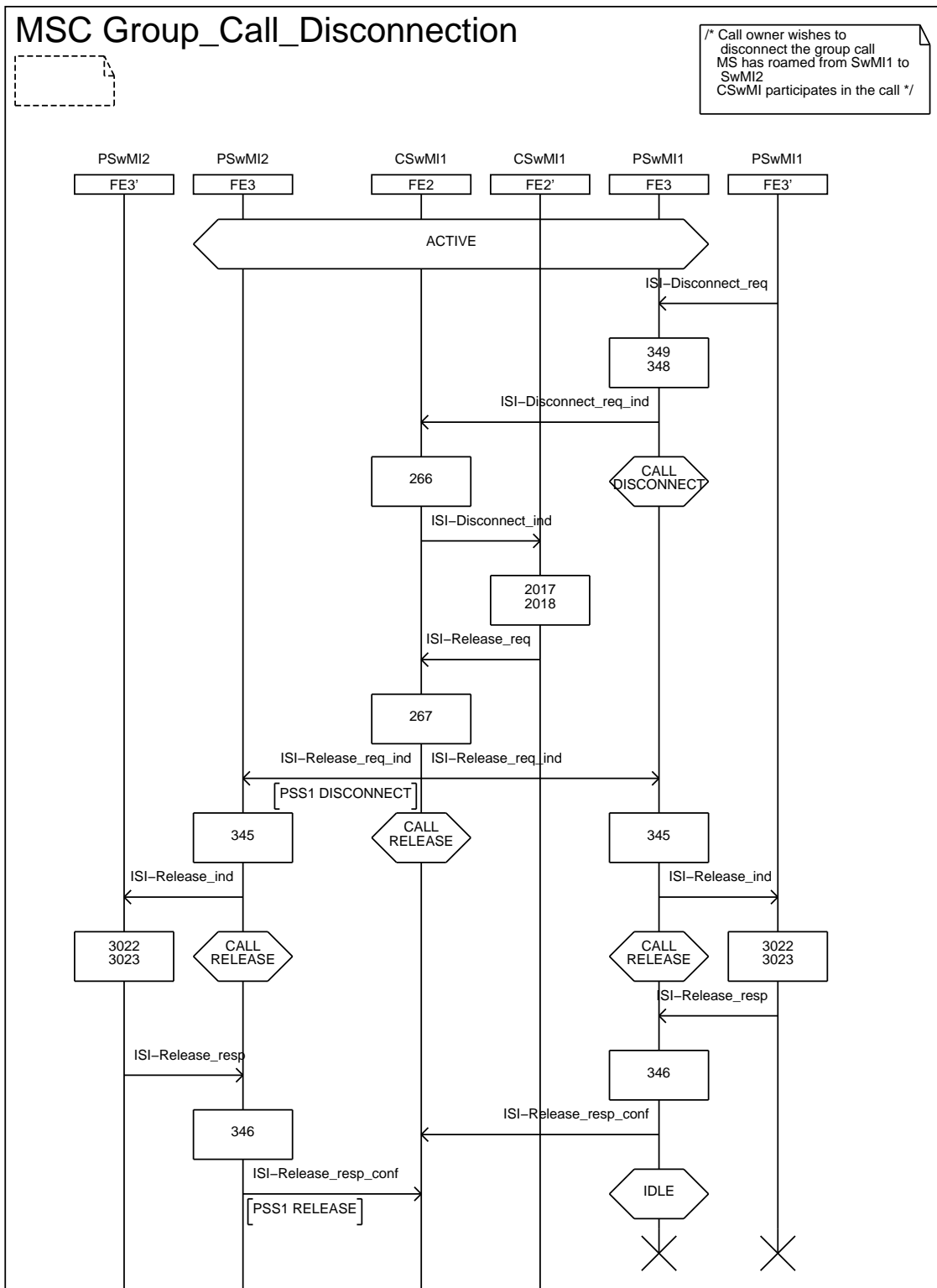
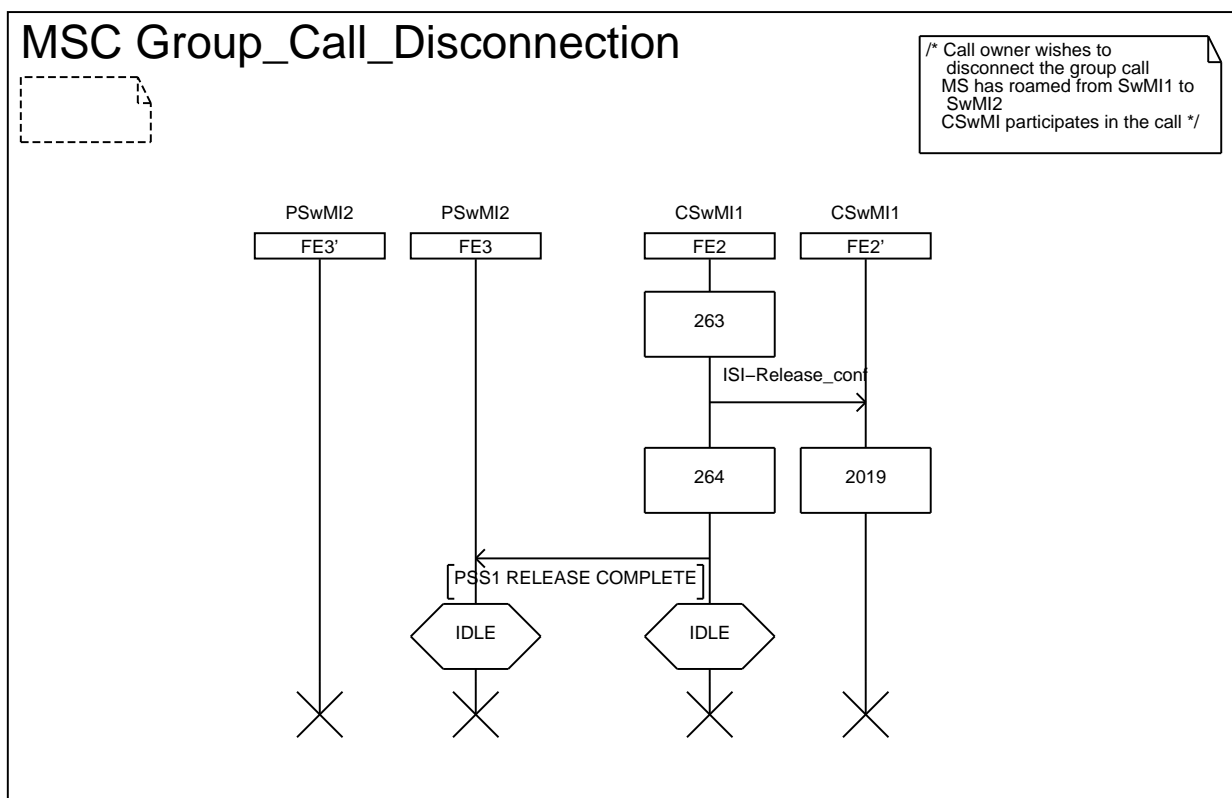


Figure 70: Information flow sequence - Group call disconnection by call owner (sheet 1 of 2)





NOTE: If required, FE3 may acquire additional information from FE5 when disconnecting.

**Figure 71: Information flow sequence - Group call disconnection by call owner (sheet 2 of 2)**

## 5.2.2 Definitions of information flows

Tables 3 to 23 list the service elements in the information flows show in clause 5.2.1. The columns headed "Request" indicates which of these service elements are Mandatory (M) and which are Optional (O) in a request/indication information flow. The columns headed "Confirm" indicates which of these service elements are Mandatory (M) and which are Optional (O) in a response/confirmation information flow.

### 5.2.2.1 ISI\_CALL RESTORATION

ISI\_CALL RESTORATION is a confirmed information flow:

- across relationship rg from FE3' to FE3;
- across relationship rf from FE3 to FE2; and
- across relationship rd from FE2 to FE2'.

ISI\_CALL RESTORATION request/indication information flow shall be sent from a participating SwMI to the controlling SwMI to confirm call restoration and to extend an active group call over ANF-ISIGC to the participating SwMI when this SwMI is not already participating in the group call.

ISI\_CALL RESTORATION response/confirm information flow shall be sent from the controlling SwMI to the participating SwMI as a response that call restoration may be accepted or not towards the migrated user.

Table 3 lists the service elements within the ISI\_CALL RESTORATION information flow.

**Table 3: Content of ISI\_CALL RESTORATION**

Service element	Request	Confirm
New SwMI MNI	M (see note 1)	-
Previous SwMI MNI	M	-
Previous SwMI call identifier	M	M (see note 3)
New SwMI call identifier	-	M (see note 4)
Restoring subscriber number	M	M
SS-CLIR invoked for restoring party	M	-
Request to transmit/send data	M (see note 2)	-
Group number	M	-
Temporary group member indication	-	M (see note 5)
Temporary group basic migration profile	-	C (see note 6)
SS migration profile	-	C (see note 7)
Transmission grant	-	M
Transmission request permission	-	M
Notification indicator	-	O
DM-MS address	O	-
Proprietary	O	O
NOTE 1: New participating SwMI for a group call. NOTE 2: This information is defined in the standard, EN 300 392-2 [3]. NOTE 3: Previous SwMI call identifier is the call ID received from the MS in the U-RESTORE. NOTE 4: New SwMI call identifier is the call identifier received in the ISI-SETUP RESPONSE from the participating SwMI. NOTE 5: This information element indicates if the restoring user is a temporary group member. NOTE 6: Depending on the value of 'temporary group member indication'. The profile is a group profile that is only valid for the duration of the group call. The profile shall reflect the restored call. NOTE 7: Depending on the value of 'temporary group member indication'. The contents of S-ISI-PROFILE shall be defined, if applicable, for the supplementary service in each supplementary service sub-part of EN/ETS 300 392-12 [9] when valid at this point in the call.		

### 5.2.2.2 ISI\_CALL RESTORATION Reject

The following table shows the call restoration reject response that may be received from the controlling SwMI in response to an ISI\_CALL RESTORATION request information flow.

Table 4 lists the service elements within the ISI\_CALL RESTORATION reject information flow.

**Table 4: Content of ISI\_CALL RESTORATION reject**

Service element	Request	Confirm
New SwMI MNI	M (see note 1)	-
Previous SwMI MNI	M	-
Previous SwMI call identifier	M	M (see note 3)
Fail Cause	-	M
Restoring subscriber number	M	M
SS-CLIR invoked for restoring party	M	-
Request to transmit/send data	M (see note 2)	-
Group number	M	-
Notification indicator	-	O
DM-MS address	O	-
Proprietary	O	O
NOTE 1: New participating SwMI for a group call. NOTE 2: This information is defined in the standard, EN 300 392-2 [3]. NOTE 3: Previous SwMI call identifier is the call ID received from the MS in the U-RESTORE.		

### 5.2.2.3 ISI\_CONNECT

ISI\_CONNECT is an unconfirmed information flow:

- across relationship rd from FE2' to FE2;
- across relationship rf from FE2 to FE3;
- across relationship rg from FE3 to FE3';
- across relationship rc from FE2 to FE1; and
- across relationship ra from FE1 to FE1'.

ISI\_CONNECT request/indication information flow shall be sent to the originating SwMI and participating SwMI(s) to inform them to through connect.

Table 5 lists the service elements within the ISI\_CONNECT information flow.

**Table 5: Content of ISI\_CONNECT**

Service element	Request
Set-up type (full, partial)	M
Basic service information	M
Security level at air interface	M
Call priority (emergency, priority 1-14)	M
Call ownership	M
Calling party information present	M
Calling user identity	C (see note)
Transmission grant	M
Transmission request permission	M
Call diverted to a dispatcher	M
Notification indicator	O
Proprietary	O
NOTE: Conditional on the calling party information present.	

### 5.2.2.4 ISI\_DISCONNECT

ISI\_DISCONNECT is an unconfirmed information flow:

- across relationship rg from FE3' to FE3;
- across relationship rf from FE3 to FE2;
- across relationship ra from FE1' to FE1;
- across relationship rc from FE1 to FE2; and
- across relationship rd from FE2' to FE2.

ISI\_DISCONNECT request/indication information flow shall be used to clear the call at the originating SwMI or a participating SwMI. The ISI\_DISCONNECT request/indication information flow shall only be sent when a SwMI wishes to be released from a group call or when the SwMI forwards a call release request made by the call owning user, when this user is located in the SwMI.

Table 6 lists the service elements within the ISI\_DISCONNECT information flow.

**Table 6: Content of ISI\_DISCONNECT**

Service element	Request
Call owner request	M
Disconnect cause	M
Proprietary	O

### 5.2.2.5 ISI\_ORIGINATING SETUP

ISI\_ORIGINATING SETUP is an unconfirmed information flow:

- across relationship rc from FE1 to FE2; and
- across relationship rd from FE2 to FE2'.

ISI\_ORIGINATING SETUP request/indication information flow shall be sent when a group call set-up request has been made in a SwMI other than the group home SwMI or linking group home SwMI.

Table 7 lists the service elements within the ISI\_ORIGINATING SETUP information flow.

**Table 7: Content of ISI\_ORIGINATING SETUP**

Service element	Request
Originating SwMI MNI	M
Calling group identity	O
Selected area number	M
Basic service information:	
Circuit mode service	M
Communication type	M
Data call capacity	C (see note 1)
Data service	C (see note 1)
Encryption flag	M
Speech service	C (see note 1)
Security level at calling user air Interface	M
Speech service requested	C (see note 2)
Call priority (emergency, priority 1 to 14)	M
SS-CLIR invoked for calling party	M
Called party identity	M
Calling party identity	M
Request to transmit/send data	M
Group attachment indicator	M (see note 4)
Speech services supported	O (see note 5)
Proprietary	O
NOTE 1: Depending on the value of circuit mode service.	
NOTE 2: May be sent if the service requested is a speech service.	
NOTE 3: Void.	
NOTE 4: This information element shall indicate whether the calling user is attached to the called group in the visited SwMI.	
NOTE 5: This element enables future additions to the TETRA air interface CODEC. This information element is not supported in the first edition of the present document.	

### 5.2.2.6 ISI\_INFO

ISI\_INFO is an unconfirmed information flow:

- across relationship rd from FE2' to FE2 or FE2 to FE2';
- across relationship rc from FE2 to FE1;
- across relationship ra from FE1 to FE1';
- across relationship rf from FE2 to FE3 or FE3 to FE2; and
- across relationship rg from FE3 to FE3' or FE3' to FE3.

ISI\_INFO request/indication information flow shall be sent as a general information message from the controlling SwMI to participating SwMI(s) and/or originating SwMI or from a participating SwMI to the controlling SwMI.

Table 8 lists the service elements within the ISI\_INFO information flow.

**Table 8: Content of ISI\_INFO**

Service element	Request
Reset call time-out timer (T310)	M
Old Call Identifier	O
New Call Identifier	O
Call time-out	O
Call time-out, set-up phase	O
Basic service information:	
Circuit mode service	O
Communication type	O
Data call capacity	C (see note 1)
Data service	C (see note 1)
Encryption flag	O
Speech service	C (see note 1)
Call ownership	O
Call status	O
Poll result identifier	O (see note 2)
Poll response percentage	C (see note 3)
Poll response number	C (see note 3)
DTMF digits	O
Group information	O
Critical called party identity	C (see note 4)
Notification indicator	O (see note 5)
Proprietary	O
NOTE 1: Depending on the value of circuit mode service.	
NOTE 2: Shall be valid for acknowledge group calls only. For other types of calls it shall be set to 0.	
NOTE 3: Depending on the value of poll result identifier.	
NOTE 4: Conditional on the information element "Group information".	
NOTE 5: Element used by the SwMI for SS's to inform members of the group call of various events.	

### 5.2.2.7 ISI\_INTERACT

ISI\_INTERACT is an unconfirmed information flow:

- from one FE2 to another FE2.

ISI\_INTERACT request/indication information flow shall be sent from one entity to another when a call set-up request is to be merged with an active group call.

Table 9 lists the service elements within the ISI\_INTERACT information flow.

**Table 9: Content of ISI\_INTERACT**

Service element	Request
Controlling call identifier	M
Originating SwMI MNI	M
Notification indicator	M
Proprietary	M

### 5.2.2.8 ISI\_POLL

ISI\_POLL is a confirmed information flow:

- across relationship rd from FE2' to FE2;
- across relationship rf from FE2 to FE3; and

- across relationship rg from FE3 to FE3'.

ISI\_POLL request/indication information flow shall be sent when the controlling SwMI wishes to poll members of the group. ISI\_POLL response/confirm information flow shall be used as a poll response sent from participating SwMI(s). The poll response shall indicate the actual status of group members located in the participating SwMI(s). Used for acknowledge group calls only.

Table 10 lists the service elements within the ISI\_POLL information flow.

**Table 10: Content of ISI\_POLL**

Service element	Request	Confirm
Poll request type	M	M
Poll response number	-	C (see note)
Poll response percentage	-	C (see note)
Poll response addresses	-	C (see note)
Proprietary	O	O
NOTE: Depending on the value of the poll request type.		

### 5.2.2.9 ISI\_REJECT

ISI\_REJECT is an unconfirmed information flow:

- across relationship rd from FE2' to FE2 or FE2 to FE2';
- across relationship rc from FE2 to FE1 or FE1 to FE2;
- across relationship ra from FE1 to FE1' or FE1' to FE1;
- across relationship rf from FE2 to FE3 or FE3 to FE2; and
- across relationship rg from FE3 to FE3' or FE3' to FE3.

ISI\_REJECT request/indication information flow shall be sent when a forward request cannot be served by the group home SwMI or the linking controlling SwMI or when a set-up request cannot be served by an invoked SwMI (this can either be the originating SwMI or a participating SwMI).

Table 11 lists the service elements within the ISI\_REJECT information flow.

**Table 11: Content of ISI\_REJECT**

Service element	Request
Reject cause	M
Notification indicator	O (see note)
Proprietary	O
NOTE: Element used by the SwMI for SS's to inform members of the group call of various events.	

### 5.2.2.10 ISI\_RELEASE

ISI\_RELEASE is a confirmed information flow:

- across relationship rd from FE2' to FE2;
- across relationship rc from FE2 to FE1;
- across relationship ra from FE1 to FE1';
- across relationship rf from FE2 to FE3; and
- across relationship rg from FE3 to FE3'.

ISI\_RELEASE request/indication information flow shall be sent to clear the call at the originating SwMI or participating SwMI(s). The ISI\_RELEASE request/indication information flow shall only be sent to a served SwMI after that SwMI has accepted a set-up request. ISI\_RELEASE response/confirm information flow shall be sent as a response from the served SwMI CC application to the served SwMI ANF-ISIGC entity that the call has been cleared.

Table 12 lists the service elements within the ISI\_RELEASE information flow.

**Table 12: Content of ISI\_RELEASE**

Service element	Request	Confirm
Disconnect type (full, partial, delay)	M	M
Disconnect cause	M	M
Notification indicator	O	-
Proprietary	O	O

### 5.2.2.11 ISI\_REROUTE

ISI\_REROUTE is an unconfirmed information flow:

- across relationship rd from FE2' to FE2;
- across relationship rc from FE2 to FE1; and
- across relationship rf from FE2 to FE3.

ISI\_REROUTE request/indication information flow shall be sent by the group home SwMI when a linking controlling SwMI exist. The originating SwMI shall re-route the call to the indicated SwMI.

The ISI\_REROUTE request/indication information flow shall also be sent during call restoration when a call restore request has been sent to the incorrect SwMI either due to group linking or due to the fact that the migrated user is participating in a call to a group that it is not a member of.

Table 13 lists the service elements within the ISI\_REROUTE information flow.

**Table 13: Content of ISI\_REROUTE**

Service element	Request
Controlling SwMI MNI	M
Notification indicator	O
Proprietary	O

### 5.2.2.12 ISI\_RESOURCE

ISI\_RESOURCE is a confirmed information flow:

- across relationship rd from FE2' to FE2;
- across relationship rf from FE2 to FE3; and
- across relationship rg from FE3 to FE3'.

ISI\_RESOURCE request/indication information flow shall be sent to all participating SwMIs with temporary allocation of resources to evaluate if resources are available for transmission when a user has request to transmit. The ISI\_RESOURCE response/confirm information flow is sent by participating SwMI(s) after evaluating if resources are available for transmission.

Table 14 lists the service elements within the ISI\_RESOURCE information flow.

**Table 14: Content of ISI\_RESOURCE**

Service element	Request	Confirm
Resource indicator	-	M
Notification indicator	O	-
Proprietary	O	O

### 5.2.2.13 ISI\_SETUP

ISI\_SETUP is a confirmed information flow:

- across relationship rd from FE2' to FE2;
- across relationship rc from FE2 to FE1;
- across relationship rf from FE2 to FE3;
- across relationship ra from FE1 to FE1'; and
- across relationship rg from FE3 to FE3'.

The ISI\_SETUP request/indication information flow enables the TETRA call to be set-up by the controlling SwMI to all SwMIs were members of the group call exist. The ISI\_SETUP response/confirm information flow is sent by invoked SwMI(s) after evaluating if resources are available for set-up of a group call.

Table 15 lists the service elements within the ISI\_SETUP information flows.

**Table 15: Content of ISI\_SETUP**

Service element	Request	Confirm
Controlling SwMI MNI	M	-
Originating SwMI MNI	M	-
Participating SwMI MNI	M	-
Call identifier	-	M
Linking group identity	O	-
Basic service information:		
Circuit mode service	M	M
Communication type	M	M
Data call capacity	C (see note 1)	C (see note 1)
Data service	C (see note 1)	C (see note 1)
Encryption flag	M	M
Speech service	C (see note 1)	C (see note 1)
Speech services chosen	C (see note 2)	-
Security level at air interface	M	M
Call priority	M	-
Call ownership	M	-
Call time-out	M	-
SS-CLIR invoked for calling party	M	-
SS-CLIR invoked for the connected group	M	-
Called/Connected party identity	M	-
Critical called party identity	O	-
Calling party identity	M (see note 3)	-
Temporary group member indication	M (see note 4)	-
Temporary group basic migration profile	C (see note 5)	-
SS-migration profile	C (see note 6)	
Resource allocation	-	M
Transmission request permission	M	-
Dispatcher acceptance	M	-
Setup response time-out	M	-
Critical user list	O	-
Notification indicator	O	-
Proprietary	O	O



Service element	Request	Confirm
NOTE 1: Depending on the value of circuit mode service.		
NOTE 2: May be sent if the service requested is a speech service.		
NOTE 3: The calling party identity is used by the originating SwMI to identify the calling user.		
NOTE 4: Indication to the originating SwMI that the calling user is temporarily a member of the called group.		
NOTE 5: Depending on the value of temporary group member indication. The profile shall reflect the actual call being connected.		
NOTE 6: Depending on the value of temporary group member indication. The contents of SS-ISI PROFILE shall be as defined, if applicable, for the supplementary service in each supplementary service sub-part of EN/ETS 300 392-12 [9].		

#### 5.2.2.14 ISI\_TX-CEASED

ISI\_TX-CEASED is an unconfirmed information flow:

- across relationship rg from FE3' to FE3 or FE3 to FE3'; and
- across relationship rf from FE3 to FE2 or FE2 to FE3.

ISI\_TX-CEASED request/indication information flow shall be sent from a participating when a user wishes to cease transmission. ISI\_TX-CEASED request/indication information flow shall be sent from the controlling SwMI to all participating SwMI(s) to indicate that the transmitting user has ceased transmission.

Table 16 lists the service elements within the ISI\_TX-CEASED information flow.

**Table 16: Content of ISI\_TX-CEASED**

Service element	Request
Requesting user identifier	M
Transmission ceased	M
Transmission request permission	C (see note)
Notification indicator	O
Proprietary	O
NOTE: Shall only be valid when this PDU has been sent from the controlling SwMI.	

#### 5.2.2.15 ISI\_TX-CONTINUE

ISI\_TX-CONTINUE is an unconfirmed information flow:

- across relationship rg from FE3' to FE3;
- across relationship rf from FE3 to FE2; and
- across relationship rd from FE2 to FE2'.

ISI\_TX-CONTINUE request/indication information flow shall be sent from a participating SwMI when it wishes to continue with a withdrawn group call.

Table 17 lists the service elements within the ISI\_TX-CONTINUE information flow.

**Table 17: Content of ISI\_TX-CONTINUE**

Service element	Request
Participating SwMI MNI	M
Proprietary	O

### 5.2.2.16 ISI\_TX-DEMAND

ISI\_TX-DEMAND is a confirmed information flow:

- across relationship rg from FE3' to FE3; and
- across relationship rf from FE3 to FE2.

ISI\_TX-DEMAND request/indication information flow shall be sent from a participating, when a member of the active group call wishes to transmit. ISI\_TX-DEMAND response/confirm information flow shall be sent from the controlling SwMI when the transmission request is either queued or rejected.

Table 18 lists the service elements within the ISI\_TX-DEMAND information flow.

**Table 18: Content of ISI\_TX-DEMAND**

Service element	Request	Confirm
Requesting party identifier	M	M
SS-CLIR invoked for requesting party	M	-
TX demand priority	M	-
Encryption control	M	-
Transmission grant	-	M
Notification indicator	M	-
Proprietary	O	O

### 5.2.2.17 ISI\_TX-GRANTED

ISI\_TX-GRANTED is an unconfirmed information flow:

- across relationship rf from FE2 to FE3; and
- across relationship rg from FE3 to FE3'.

ISI\_TX-GRANTED request/indication information flow shall be sent to the participating SwMI(s) to indicate that permission to transmit has been granted to a member of the active group call.

Table 19 lists the service elements within the ISI\_TX-GRANTED information flow.

**Table 19: Content of ISI\_TX-GRANTED**

Service element	Request
SS-CLIR invoked for transmitting party	M (see note)
Transmission request permission	M
Transmission grant	M
Encryption control	M
Transmitting party identifier	O
Notification indicator	O
Proprietary	O
NOTE: Talking party identification shall be presented.	

### 5.2.2.18 ISI\_TX-INTERRUPT

ISI\_TX-INTERRUPT is an unconfirmed information flow:

- across relationship rf from FE2 to FE3; and
- across relationship rg from FE3 to FE3'.

ISI\_TX-INTERRUPT request/indication information flow shall be sent to the participating SwMI(s) to indicate that transmission has been interrupted and granted to another user.

Table 20 lists the service elements within the ISI\_TX-INTERRUPT information flow.

**Table 20: Content of ISI\_TX-INTERRUPT**

Service element	Request
SS-CLIR invoked for transmitting party	M (see note)
Transmission request permission	M
Transmission grant	M
Encryption control	M
Transmitting party identifier	M
Notification indicator	O
Proprietary	O
NOTE: Talking party identification shall be presented.	

### 5.2.2.19 ISI\_TX-WAIT

ISI\_TX-WAIT is an unconfirmed information flow:

- across relationship rg from FE3' to FE3;
- across relationship rf from FE3 to FE2; and
- across relationship rd from FE2 to FE2'.

ISI\_TX-WAIT request/indication information flow shall be sent from a participating SwMI when it wishes to withdraw from an active group call.

Table 21 lists the service elements within the ISI\_TX-WAIT information flow.

**Table 21: Content of ISI\_TX-WAIT**

Service element	Request
Participating SwMI MNI	M
Proprietary	O

### 5.2.2.20 VERIFY\_GROUP

VERIFY\_GROUP is a confirmed information flow:

- across relationship re from FE2 to FE5.

The VERIFY\_GROUP request information flow shall be sent by FE2 when routing and linking information is requested. The VERIFY\_GROUP response information flow shall be used to return the requested information to FE2.

Table 22 lists the service elements within the VERIFY\_GROUP information flow.

**Table 22: Content of VERIFY\_GROUP**

Service element	Request	Confirm
Requesting Network (MCC+MNI)	M	M
Requested information indicator	M	M
GTSI	-	M
Location Information	-	O (see note)
Group linking information	-	O (see note)
NOTE: Depending on the value of requested information indicator.		

### 5.2.2.21 VERIFY\_INDIV

VERIFY\_INDIV is a confirmed information flow:

- across relationship rb from FE1 to FE4.

The VERIFY\_INDIV request information flow shall be sent by FE1 when service information is required for the calling user. The VERIFY\_INDIV response information flow shall be used to return the requested information to FE2.

Table 23 lists the service elements within the VERIFY\_INDIV information flow.

**Table 23: Content of VERIFY\_INDIV**

Service element	Request	Confirm
Requesting Network (MCC+MNI)	M	M
Requested information indicator	M	M
ITSI	-	M
Individual profile information	-	O (see note)
Individual SS-profile information	-	O (see note)
NOTE: Depending on the value of requested information indicator.		

## 5.3 Functional Entity Actions (FEAs)

The following FE actions shall occur at the points indicated in figures in clause 5.2.1.

### 5.3.1 FEA of FE1

- 101 Detect an outgoing ISI group call request send from an originating SwMI CC application (FE1').
- 102 Send a VERIFY\_INDIV req. to FE4 requesting the services profile of the calling MS and wait for a response.
- 103 Retrieve the service profile of the calling MS from FE4 and evaluate if the calling MS is a member of the group.
- 104 Obtain the routeing information to the controlling SwMI, FE1. Send ISI\_ORIGINATING SETUP req.ind. over the ISI to FE2 for further processing.
- 105 FE1 and FE2 are not collocated. Inform the originating SwMI FE1', that the call has been forwarded to the controlling SwMI, FE2, for further processing. A delay may occur.
- 106 Receive an ISI\_SETUP req.ind. from FE2 requesting that a group call is to be set-up in this SwMI to all MSs attached to the called GTSI.
- 107 Forward the request to FE1' for evaluation.
- 108 Receive an ISI\_SETUP resp. form FE1'.
- 109 Send an ISI\_SETUP resp.conf. to FE2 confirming that the SwMI is able to participate in the call and ready for the through connection of the call. Wait for a response from FE2 on the through connection request.
- 110 Receive an ISI\_CONNECT req.ind. from FE2 indicating that the group call is about to be through connected.
- 111 Inform FE1' to connect the calling user using the reserved resources. Initiate a FE3.
- 112 The group call set-up is to be delayed.
- 113 Inform FE1' of the delayed call with an ISI\_RELEASE ind.
- 114 The reserved resources have been released. Call set-up has now been delayed.
- 115 Inform FE2 that call set-up has been delayed.
- 116 FE1 shall now be considered as a participating SwMI, FE3.
- 117 The group call request has been rejected by the group home SwMI.
- 118 Inform FE1' of the rejected group call request.
- 119 The group call set-up has been rejected. The call will be released.

- 120 Inform FE1' of the rejected call set-up with an ISI\_RELEASE ind.
- 121 The reserved resources have been released. Release the ISI-path.
- 122 Inform FE2 that the ISI-path and group call has been released.
- 123 The group call request is merged to an active call.
- 124 An ISI\_INFO req.ind. has been received from the controlling SwMI. Forward this information to FE1'.

### 5.3.2 FEA of FE1'

- 1001 Detect an outgoing group call request sent over the air interface. Analyse the calling MS's profiles and the called group identity (GTSI). Evaluate if the MS is allowed to initiate an ISI group call and whether or not the MS is allowed to use the requested tele or bearer service across the ISI.
- 1002 Forward the group call request to the originating FE1.
- 1003 Call control has been forwarded to the called groups home SwMI. Wait for a call set-up request.
- 1004 Evaluate if the necessary resources are available for a group call. If a group call can be performed in the originating SwMI(s), the necessary resources should be reserved.
- 1005 Send an ISI\_SETUP resp. to FE1 confirming that the SwMI is able to participate in the call and ready for the through connection of the call. Wait for the through connection request.
- 1006 Connect calling user.
- 1007 The group call set-up is delayed. Release reserved resources. The ISI-path shall be maintained.
- 1008 The call set-up request has been rejected by the group home SwMI.
- 1009 The group call set-up is rejected. Release the reserved resources and the ISI-path.
- 1010 Evaluate the received call data (basic service information).
- 1011 An ISI\_INFO PDU has been sent from the controlling SwMI. Inform the calling user.

### 5.3.3 FEA of FE2

- 201 Receive forwarded information as an ISI\_ORIGINATING SETUP req.ind. from FE1 convey this information to FE2' to be evaluated.
- 202 Convey information to FE2' to be evaluated.
- 203 The called group has been evaluated by the group home or linking controlling SwMI. Set-up the group call to all indicated SwMIs.
- 204 Send a VERIFY\_GROUP req. to FE5 requesting the called groups routeing information.
- 205 Retrieve the routeing information of the called group from FE5. Check if the called group is linked.
- 206 The called group is linked and the group home SwMI is not the linking controlling SwMI. FE1 and FE2 are not collocated. Inform the originating SwMI, FE1, to re-route the ISI-ORIGINATING SETUP req.ind. to the linking controlling SwMI. An ISI-REROUTE req.ind. is sent to the originating SwMI.
- 207 Inform the originating SwMI of the call time out for the set-up phase and of call status.
- 208 The called user group is linked and the group home SwMI is not the linking controlling SwMI. Analyse the called group number and obtain the routeing information to the linking controlling SwMI. Send ISI\_ORIGINATING SETUP req.ind. over the ISI to the new FE2 for further processing.
- 209 Inform the group home SwMI FE2', that the call has been forwarded to the linking controlling SwMI, new FE2, for further processing. A delay may occur.

- 210 Release the PISN connection oriented, call independent call between the linking controlling SwMI (new FE2) and the group home SwMI (FE2). The group home SwMI shall now be considered a participating SwMI, FE3.
- 211 If an ISI\_ORIGINATING SETUP PDU has been received, then evaluate the set-up information received in the PDU. If services cannot be supported by the controlling SwMI, then the services shall be changed to supported values.
- Send an ISI\_SETUP req.ind. over the ISI to the SwMI(s) indicated by the routing information. The ISI\_SETUP req.ind. shall also be sent to the originating SwMI. Wait for an ISI\_SETUP resp.conf. from important or all invoked participating SwMIs (FE3s) and the originating SwMI.
- 212 Send an ISI\_REJECT req.ind. over the ISI to the originating FE1. Release the PISN connection oriented, call related connection between the group home SwMI (FE2) and the originating SwMI (FE1).
- 213 Receive all ISI\_SETUP resp.conf. and ISI\_REJECT req.ind. from FE3s or FE1. Collect all responses and forward them to FE2'.
- 214 Receive an ISI\_CONNECT req. from FE2'. Connect the group call to the FE3s and FE1 indicated in the ISI\_CONNECT req.
- 215 Send an ISI\_CONNECT req.ind. to the indicated SwMI(s).
- 216 Receive an ISI\_RELEASE req. from a FE2'. Release the SwMIs (FE3s and FE1) indicated in the ISI\_RELEASE req. If the call set-up is to be delayed the ISI-path shall be maintained.
- 217 Send the ISI\_RELEASE req.ind. to the indicated SwMIs.
- 218 Inform FE2' that the group call is now delayed.
- 219 Receive an ISI\_SETUP resp.conf. from the delaying FE3 confirming that the participating SwMI is able to set-up the call and requesting that the call is through connected.
- 220 Forward the ISI\_SETUP conf. to FE2'.
- 221 Send an ISI\_SETUP req.ind. to the delayed FE3s informing them that the group call set-up shall continue.
- 222 Receive an ISI\_SETUP resp.conf. from all delayed SwMIs each of them confirming that the participating SwMI is able to set-up the call and requesting that the call is through connected.
- 223 An acknowledged group call is to be performed. The calling user has received permission to transmit before the polling request. However, permission to transmit can also be granted to the calling user during and after the polling request.
- 224 Send an ISI\_POLL req.ind. to the FE3s informing that group members are to be polled.
- 225 Convey all received polling responses from FE3s back to FE2'.
- 226 The group call has been released. Complete the release of the ISI-path.
- 227 The ISI-path is released. Inform FE2' that the release is complete.
- 228 The new B-channel received in the PSS1 CONNECT message is unacceptable. The call shall be released.
- 229 AN ISI\_TX\_DEMAND req.ind. has been received from a participating SwMI. Evaluate if the transmission request conflicts with any currently granted transmission. Only one participating SwMI is awarded the right to transmit while other transmission requests shall be queued or rejected.
- 230 Send an ISI\_RESOURCE req.ind. over the ISI to all participating FE3s with temporary resources.
- 231 Send a VERIFY\_GROUP req. to FE5 requesting routing information.
- 232 Retrieve the routing information of the called group from FE5. Check FE5 if any new SwMIs (SwMIs not participating in the active group call) with group members are registered in the controlling SwMI.
- 233 Send an ISI\_SETUP req.ind. over the ISI to the newly registered FE3s. Wait for ISI\_SETUP resp.conf. from important or all FE3s.

- 234 Receive all ISI\_SETUP resp.conf. and ISI\_RESOURCE resp.conf. from FE3s. Collect all responses. Wait for an ISI\_CONNECT or ISI\_RELEASE PDU from FE2' if new SwMI(s) is/are being connected to the active call.
- 235 Evaluate if transmission can be granted to the requesting user.
- 236 Permission to transmit has been granted. Inform the granted user of the permission to transmit with an ISI\_TX\_GRANTED PDU. The parameter value, transmission grant, is set to 'transmission granted'. The other users involved in the call are also informed of the granted transmission by an ISI\_TX\_GRANTED PDU. The parameter value, transmission grant, is set to 'transmission granted to another user'. The ISI\_TX\_GRANTED PDU is group addressed, but it shall contain an individual address as to who has received transmission permission.
- 237 The transmission request has been queued. The requested user is informed of the queued request by setting the 'transmission request queued' parameter value in the ISI\_TX\_DEMAND resp.conf.
- 237a Permission to transmit has been delayed. Inform the SwMIs with temporary resources of the transmission delay with an ISI\_TX\_CEASED PDU. The parameter value, transmission ceased, is set to "Delay transmission request". The ISI\_TX\_CEASED PDU is group addressed, but it shall contain an individual address as to who requested transmission permission.
- 238 The transmission request has been rejected. The requested user is informed of the queued request by setting the "transmission not granted" parameter value in the ISI\_TX\_DEMAND resp.conf.
- 239 A pre-emptive priority request has been received. Check if a user currently has transmission rights.
- 240 The transmitting user is interrupted by sending an ISI\_TX\_INTERRUPT req.ind. The parameter value, transmission grant, is set to 'transmission granted to another user'.
- 241 The other users involved in the call are informed of the interrupted transmission by sending an ISI\_TX\_INTERRUPT req.ind. The parameter value, transmission grant, is set to 'transmission granted to another user'. The ISI\_TX\_INTERRUPT PDU is group addressed, but it shall contain an individual address as to who has received transmission permission.
- 242 An ISI\_TX\_CEASED req.ind. has been received from a participating SwMI. Check if the PDU has been sent from the user that currently has transmission rights.
- 243 Transmission has seized. Check if requests to transmit have been queued in the controlling SwMI.
- 244 No request to transmit has been queued in the controlling SwMI. Inform all users participating in the group call that transmission has ended.
- 245 Requests to transmit are queued in the controlling SwMI. Grant permission to transmit to the first user in queue with the highest priority transmission request.
- 246 A user wishes to withdraw a request to transmit in the controlling SwMI. Remove request. No response is sent back to the user.
- 247 AN ISI\_TX\_WAIT req.ind. has been received from a participating SwMI. Evaluate if the group call shall continue or be released.
- 248 The active group call is to continue without the withdrawn participating SwMI. No response is sent back to the withdrawn SwMI.
- 249 A withdrawn SwMI wishes to continue with the active group call. If a user located in the withdrawn SwMI was transmitting at the time of withdrawal, permission to transmit shall not automatically be given to this user upon continuation in the active call. Users located in the withdrawn participating SwMI may request permission to transmit during withdrawal. However, if a queuing mechanism is not implemented in the controlling SwMI for transmission control, all transmission request sent from a withdrawn SwMI shall be rejected. Transmission permission shall not be granted to a user in a withdrawn SwMI.
- 250 The withdrawn participating SwMI has rejoined the active group call. No response is sent back to the SwMI.
- 251 The controlling SwMI wishes to send information out to the participating SwMI(s).
- 252 A request is received from, the group home or linking controlling SwMI to perform call restoration.

- 253 Inform FE2' of the call restoration request.
- 253a Re-route call restoration request to the indicated SwMI.
- 254 Call Restoration has been accepted. Check if ISI-path exists to the participating SwMI.
- 254a ISI-path does not exist to the new participating SwMI. Extend the call to the new participating SwMI.
- 255a The call set-up has been accepted by the new participating SwMI. Send an ISI\_CONNECT req.ind. to the new participating SwMI.
- 256 ISI-path exists at the new participating SwMI. Check in the group database, FE5, if the migrated user was the last member of the group at the old SwMI.
- 257 Check if the last user has migrated from the old participating SwMI.
- 258 The last user has migrated. Release the ISI-path to the old participating SwMI.
- 259 The last user has not migrated from the old participating SwMI. Call restoration is now complete.
- 260 The old participating SwMI has been released.
- 261 The controlling SwMI wishes to terminate the group call, e.g. resources are required for another call, failed service modification or the call time out timer has timed out.
- 262 The controlling SwMI shall inform all participating SwMI(s) of the call disconnection in an ISI\_RELEASE req.ind. Reason for disconnection shall be sent along in the PDU.
- 263 Collect all responses and forward them to FE2'.
- 264 Release the PISN connection oriented call related call, between the controlling SwMI (FE2) and all participating SwMI(s) (FE3).
- 265 A participating SwMI wishes to be released from the group call. Inform the FE2' for evaluation.
- 266 The call owner has initiated disconnection of the group call. Inform FE2' of the disconnection.
- 267 The controlling SwMI shall inform the release requesting SwMI of the call disconnection in an ISI\_RELEASE req.ind. Reason for disconnection shall be sent along in the PDU.
- 268 This ANF-ISIGC entity is to interact with an active ANF-ISIGC entity.
- 269 A user who is not participating in the group call wishes to join the active group call.
- 270 Inform the originating SwMI that the group call request is to be merged with an active call. The calling user (merged user) will be indicated in the ISI-SETUP req.ind. The calling party information element shall indicate the current transmitting party.
- 272 An ISI path already exists to the SwMI. Inform the SwMI of which call the migrated user may restore and if the migrated user is a temporarily a member of the called group.
- 273 Forward call restoration information to the call control application (FE2').

#### 5.3.4 Functional entity actions of FE2'

- 2001 Receive forwarded information as an ISI\_ORIGINATING SETUP ind. from FE2 requesting that a group call be made to all MSs attached to the called GTSI. Evaluate if the group call can be performed. If the group call has been initiated by a user which is not a member of the group, then the group home SwMI shall evaluate the user profile of the called group. The group profile shall indicate that a group call, made by a foreign user, can be initiated.
- 2002 Request FE2 to set-up the group call to all MSs attached to the called GTSI.
- 2003 The call set-up request is re-routed to the linking controlling SwMI.



- 2004 Receive an ISI\_SETUP conf. from FE2 where all received set-up responses are collected. Evaluate the received responses. FE2' may at any time choose to proceed with the set-up towards the active phase although not all participating SwMIs have responded or participating SwMIs wish to delay the call.
- 2005 Send an ISI\_CONNECT req. to FE2 requesting that the group call be through connected.
- 2006 The group call is to be delayed. Request FE2 to release the indicated SwMIs.
- 2007 No further actions are taken for this call. Wait for a response from the delaying SwMI(s).
- 2008 A partial group call is to be set-up. Send an ISI\_CONNECT req. to FE2 requesting that the group call be through connected.
- 2009 Request FE2 to interact with an active ANF-ISIGC. An individual who is not a member of the group is to join the active group call.
- 2010 Resolve status on the existing call.
- 2011 Merge the calling user into the call.
- 2012 A group call cannot be made to the called group. Request FE2 to reject the group call request.
- 2013 A group call cannot be made to the called group. Request FE2 to release the group call request.
- 2014 Evaluate call restoration request.
- 2015 Inform FE2 that the call restoration has been accepted.
- 2016 A participating SwMI wishes to be released from the group call. Evaluate if the group call should continue without the participating SwMI or if the call should be released.
- 2017 The call is to continue without the release requesting SwMI. Inform the SwMI that it shall release from the call.
- 2018 The call owner has initiated disconnection of the group call. Inform FE2 to send an ISI\_RELEASE req.ind. to all indicated participating SwMI(s).
- 2019 Release is complete.
- 2020 Call restoration information has been received from the migrated user's old visiting SwMI.

### 5.3.5 FEA of FE3

- 301 Receive an ISI\_SETUP req.ind. from FE2 requesting that a group call is to be set-up in this SwMI to all MSs attached to the called GTSI.
- 302 Forward the request to FE3' for evaluation.
- 303 Receive an ISI\_SETUP resp. form FE3'.
- 304 Send an ISI\_SETUP resp.conf. to FE2 confirming that the SwMI is able to participate in the call and ready for the through connection of the call. Wait for a response from FE2 on the through connection request.
- 305 Receive an ISI\_REJECT req. from FE3'.
- 306 Forward the rejected call set-up to FE2. Wait for a response from FE2.
- 307 Receive an ISI\_CONNECT req.ind. from FE2 indicating that the group call is about to be through connected.
- 308 Inform FE3' to connect members of the group call using reserved resources.
- 309 FE3 should co-ordinate the call identity with FE1 and then connect non active group members of the group call using reserved resources.
- 310 The group call set-up is to be delayed.
- 311 Inform FE3' of the delayed call with an ISI\_RELEASE ind.

- 312 The reserved resources have been released. Call set-up has now been delayed.
- 313 Inform FE2 that call set-up has been delayed.
- 314 Receive an ISI\_POLL req.ind. from FE2 indicating that group members shall be polled.
- 315 Request the participating SwMI CC application to poll group members in the active call.
- 316 Result of polling request received.
- 317 Inform FE2 of the polling result in an ISI\_POLL resp.conf. PDU.
- 318 The group call set-up is to be released.
- 319 Inform FE3' of call release with an ISI\_RELEASE ind.
- 320 The reserved resources have been released. Release the ISI-path.
- 321 Inform FE2 that the ISI-path has been released.
- 322 The indicated B-channel is not available. A new B-channel is reserved by the participating SwMI.
- 323 A user wishes to transmit. The request to transmit is forwarded to the controlling SwMI for evaluation.
- 324 Receive an ISI\_RESOURCE req.ind. from FE2 requesting the SwMI to evaluate if resources are available for transmission.
- 325 Forward the request to FE3' for evaluation.
- 326 Receive an ISI\_RESOURCE resp. form FE3'.
- 327 Send an ISI\_RESOURCE resp.conf. to FE2 confirming that the SwMI is able to participate. Wait for a transmission grant from FE2.
- 328 An ISI\_TX\_GRANTED, ISI\_TX\_CEASED or an ISI\_TX\_DEMAND PDU has been received from the controlling SwMI. Inform FE3' of the transmission request result.
- 329 An ISI\_TX\_INTERRUPT req.ind. has been received. Interrupt transmission.
- 330 An ISI\_TX\_INTERRUPT req.ind. has been received from the controlling SwMI. Inform the users participating in the group call that transmission has been interrupted and granted to another user.
- 331 A user has ended transmission or wishes to withdraw a request for transmission. The controlling SwMI is informed with an ISI\_TX\_CEASED req.ind.
- 332 Transmission has seized. No user has currently received permission to transmit.
- 333 A participating SwMI wishes to withdraw from the active call. The controlling SwMI is informed of the withdrawal.
- 334 A participating SwMI wishes to continue with an active group call. The controlling SwMI is informed with an ISI\_TX\_CONTINUE req.ind.
- 335 An ISI\_INFO req.ind. has been received from the controlling SwMI. Forward this information to FE3'.
- 336 Inform the linking controlling SwMI to perform call restoration.
- 337 Send ISI\_CALL RESTORATION req.ind. to FE2.
- 338 Re-route ISI\_CALL RESTORATION req.ind.
- 339 Call restoration has been accepted. Inform FE3' of acceptance.
- 340 Send an ISI\_CALL RESTORATION resp.conf. to FE2.
- 341 Receive an indication to remove the active ISI-path and group call connections.
- 342 Forward this information to the CC application of the SwMI, FE3'.

- 343 The group call has been released. Release the ISI-path.
- 344 Inform FE2 that the ISI-path has been released.
- 345 An ISI-RELEASE req.ind. has been received. Inform the participating SwMI call control application that the call is to be disconnected immediately.
- 346 Inform the controlling SwMI that the call has been disconnected in the participating SwMI.
- 347 The participating SwMI wishes to be released from the group call, e.g. resources are required for another call or the call time out timer has timed out.
- 348 The participating SwMI shall inform the controlling SwMI(s) of the call disconnection in an ISI\_DISCONNECT req.ind. Reason for disconnection shall be sent along in the PDU.
- 349 The call owner has initiated a disconnect of the entire group call.
- 350 Call restoration information is received for the migrated user. Inform FE3'.
- 351 Call restoration has been performed towards the migrated user.
- 352 The group call is to be restored to the migrated user in the new visiting SwMI.
- 353 Fetch call information.
- 354 Forward the call information necessary for call restoration in the group home SwMI.
- 355 Release the PISN connection oriented, call independent connection between the migrated user's home SwMI and the old visiting SwMI.
- 356 Receive an ISI\_DELAY req. from FE3'.
- 357 Forward the delay request to FE2. Wait for a response from FE2.

### 5.3.6 Functional entity actions of FE3'

- 3001 Evaluate if the necessary resources are available and that group members exist in the participating SwMI. If a group call can be performed in the participating SwMI, the necessary resources should be reserved.
- 3002 Send an ISI\_SETUP resp. to FE3 confirming that the SwMI is able to participate in the call and ready for the through connection of the call. Wait for through connection request.
- 3003 Connect group members using reserved resources.
- 3004 Send an ISI\_DELAY req. to FE3 indicating that the SwMI wishes the call set-up to be delayed.
- 3005 Send an ISI\_REJECT req. to FE3 indicating that the SwMI cannot support the group call set-up.
- 3006 The group call set-up is delayed. Release reserved resources. The ISI-path shall be maintained.
- 3007 The delaying SwMI now wishes to continue with call set-up. Inform the controlling SwMI that FE3 can now participate in the call.
- 3008 The participating SwMI CC application (FE3') is requested to poll all indicated users.
- 3009 The result of polling is sent back to FE3.
- 3010 The group call set-up to be released. Release the reserved resources and the ISI-path.
- 3011 Transmission is granted to the requesting user. Inform the requesting user and members of the group call of granted transmission.
- 3012 The transmission request has either been queued or rejected. May inform the requesting user of transmission request result.
- 3013 The current transmission is interrupted. Inform the transmitting user and the members of the group call of the interruption. Inform the requesting user that transmission is granted.

- 3014 Inform group members that transmission has seized.
- 3015 An ISI\_INFO PDU has been sent from the controlling SwMI. Inform members of the group call.
- 3016 The group home SwMI Mobility Management application has requested the Call Control (CC) application to perform call restoration.
- 3017 The group is linked to another group and this SwMI is not the linking controlling SwMI. The linking controlling SwMI shall perform call restoration.
- 3018 The migrated user has request group call restoration.
- 3019 Request controlling SwMI to confirm call restoration.
- 3019a Inform migrated user of call restoration acceptance.
- 3020 Release all used and reserved resources in the group call.
- 3021 Inform FE3 that the group call has been released.
- 3022 The group call is to be disconnected. Release all used and reserved resources. Inform the members of the group call of the disconnection.
- 3023 The members of the group call have been disconnected and all resources are released.
- 3024 Evaluate if the necessary resources are available and that group members exist in the participating SwMI. If transmission can be performed in the participating SwMI(s), the necessary resources should be reserved.
- 3025 Send an ISI\_RESOURCE resp. to FE3 confirming that the SwMI is able to participate. Wait for transmission granted.
- 3026 Fetch call information for the migrated user.
- 3027 Resources are now available for transmission.

### 5.3.7 Functional entity actions of FE4

- 401 Receive a VERIFY\_INDIV req. from FE1' indicating a query for service profile and attributes of an individual MS. Retrieve the requested information from the database.
- 402 Send a VERIFY\_INDIV ind. Back to the FE1' with the result of the service profile query, i.e. either the detailed individual MS information or a rejection of the VERIFY\_INDIV req.ind.

### 5.3.8 Functional entity actions of FE5

- 501 Receive a VERIFY\_GROUP req. from FE2 indicating a query for the user profile and the routing information of the called group. Retrieve the requested information from the database.
- 502 Send a VERIFY\_GROUP ind. To FE2 containing the user profile and routing information of the called group including, if appropriate, the assigned VGSSI or GSSI for the participating SwMI.
- 503 Receive a VERIFY\_GROUP req. from FE2 indicating a query for migration information of the called group. Retrieve the requested information from the database.
- 504 Send a VERIFY\_GROUP ind. To FE2 containing the migration information of the called group.

---

## 6 ANF-ISIGC stage 3 specification

### 6.1 ANF-ISIGC description

See clause 4.

### 6.2 ANF-ISIGC operational requirements

The requirements specific for each type of SwMI are stated below. In addition, each SwMI shall comply with the requirements stated in:

- annex ZA of ISO/IEC 11572 [11], for the support of the PSS1 message segmentation/re-assembly procedures; and
- clause 8.4 of EN 300 392-3-1 [4], for the support of the ROSE protocol.

#### 6.2.1 PISN connection oriented call related connection

##### 6.2.1.1 Requirements on the originating SwMI

###### 6.2.1.1.1 PSS1 SETUP message

The originating SwMI shall invoke an ANF-ISIGC entity to support a connection oriented call related connection used for sending a forward group call set-up request. The invoked ANF-ISIGC entity shall support call related establishment and clearing procedures as for an originating PINX, as specified in ISO/IEC 11572 [11] (clause 10.5). In addition, the following rules shall apply for the information elements of the PSS1 SETUP message:

- the sending complete information element shall be included because the called party number is always complete;

NOTE 1: For calls originating from an incoming gateway, the gateway application in the originating SwMI sends send the called party identity en-bloc.

- the bearer capability information element shall be encoded with information transfer capability code equal to unrestricted digital information, and an information transfer rate code equal to 64 kbit/s;
- no progress indicator information element shall be included;
- the calling party number information element shall be included. The corresponding number shall be a PISN number identifying the originating SwMI, or one of its entities. Thus its numbering plan identification shall be equal to either private numbering plan or unknown. No presentation or screening indicators shall be included (i.e. the calling party information element shall not include octet 3a);

NOTE 2: The type of number associated to the calling party number information element is defined as shown in table 26 of ISO/IEC 11572 [11].

NOTE 3: The calling party identity (identity identifying the calling user) is part of the complementary TETRA forward information (see table 24).

- no calling party subaddress information element shall be included;
- the number included in the called party number information element shall be a PISN number identifying the called group's home SwMI or the controlling SwMI or one of its entities. The PISN number for the controlling SwMI shall be used when the call has been re-routed. Thus its numbering plan identification shall be equal to either private numbering plan or unknown;

NOTE 4: The type of number associated to the called party number information element is defined as shown in table 26 of ISO/IEC 11572 [11].

- no called party subaddress information element shall be included;
- no lower layer or high layer compatibility information elements shall be included; and
- the transit counter information element, defined in EN 300 172 [1], may be included.

Generic procedures for call related signalling of supplementary services to and from an End PINX, specified in ISO/IEC 11582 [13], shall apply for sending or receiving TETRA specific messages or TETRA information complementary to PSS1 basic call messages. Such messages or complementary information shall be encoded as ROSE operation Invoke APDUs in facility information elements. Notably, the encoded APDUs shall be sent in facility information elements in the PSS1 SETUP message.

## 6.2.1.2 Requirements on the group home SwMI

### 6.2.1.2.1 PSS1 DISCONNECT or PSS1 RELEASE COMPLETE message

The group home SwMI shall release the call related connection to the originating when the group home SwMI is not the controlling SwMI and the call is to be re-routed or if the group home SwMI cannot accept the incoming group call. A PSS1 RELEASE COMPLETE message shall be sent to the originating SwMI when no PSS1 message previously has been sent in response to the PSS1 SETUP message. Otherwise a PSS1 DISCONNECT message is sent. The following rules shall apply for the cause information element of the PSS1 DISCONNECT or PSS1 RELEASE COMPLETE message:

- the location area shall be set to private network serving the local user;
- the cause value shall be set to normal, unspecified when the call is to be re-routed.

## 6.2.1.3 Requirements on the controlling SwMI

### 6.2.1.3.1 PSS1 DISCONNECT or PSS1 RELEASE COMPLETE message

The controlling SwMI shall release the call related connection to the originating SwMI when the controlling SwMI cannot accept the incoming group call. A PSS1 RELEASE COMPLETE message shall be sent to the originating SwMI when no PSS1 message previously has been sent in response to the PSS1 SETUP message. Otherwise a PSS1 DISCONNECT message is sent. The following rules shall apply for the cause information element of the PSS1 DISCONNECT or PSS1 RELEASE COMPLETE message:

- the location area shall be set to private network serving the local user.

### 6.2.1.3.2 PSS1 SETUP message

The controlling SwMI shall use the invoke ANF-ISIGC entity (see clause 6.2.1.3.3) to support call establishment and call clearing procedures as for an Originating PINX, as specified in ISO/IEC 11572 [11]. In addition, the following rules shall apply for the information elements of the PSS1 SETUP message:

- the sending complete information element shall always be included. The complete called number shall always be received from the originating SwMI in the forward group call set-up request;
- the bearer capability information element shall be encoded with information transfer capability equal to unrestricted digital information, and an information transfer rate equal to 64 kbit/s;
- no progress indicator information element shall be included;
- the calling party number information element shall be included. The corresponding number shall be a PISN number identifying the participating SwMI or one of its entities. Thus its numbering plan identification shall be equal to either private numbering plan or unknown. No presentation or screening indicators shall be included (i.e. the calling party information element shall not include octet 3a);

NOTE 1: The type of number associated to the calling party number information element is defined as shown in table 26 of ISO/IEC 11572 [11].

- no calling party subaddress information element shall be included;

- the number included in the called party number information element shall be a PISN number identifying the controlling SwMI or one of its entities. Thus its numbering plan identification shall be equal to either private numbering plan or unknown;

NOTE 2: The type of number associated to the called party number information element is defined as shown in table 26 of ISO/IEC 11572 [11].

- no called party subaddress information element shall be included;
- no lower layer or high layer compatibility information elements shall be included; and
- the transit counter information element, defined in EN 300 172 [1], may be included.

Generic procedures for the call related control of supplementary services, specified in ISO/IEC 11582 [13] for an End PINX, shall apply for sending or receiving TETRA specific messages or TETRA information complementary to PSS1 basic call messages. Such messages or complementary information shall be encoded as ROSE operation Invoke APDUs in facility information elements. Notably, the encoded APDUs shall be sent in facility information element in the PSS1 SETUP message.

### 6.2.1.3.3 PSS1 CONNECT message

The controlling SwMI shall invoke an ANF-ISIGC entity to support call establishment and call clearing procedures as for a terminating PINX, as specified in ISO/IEC 11572 [11], when a call set-up request is received from the originating SwMI. When the controlling SwMI has accepted the call set-up request, a PSS1 CONNECT message shall be sent to the originating SwMI as a response to the PSS1 SETUP message. The following rules shall apply for the contents of the connected number and connected subaddress information elements in the PSS1 CONNECT message:

- the connected number information element shall be included. The connected number shall correspond to the controlling SwMI or one of its entities. Thus its numbering plan identification shall be equal to either private numbering plan or unknown. No presentation or screening indicators shall be included (i.e. the connected information element shall not include octet 3a);
- no connected party subaddress information element shall be included;
- no progress indicator should be included, since no tones or announcements are sent, and it shall not be considered that an interworking situation occurs for inter-TETRA group calls. For the same reason, no PSS1 PROGRESS message should be sent;
- the channel indication information element may indicate a new information channel as described in clause 10.1.2 of ISO/IEC 11572 [11].

Generic procedures for the call related control of supplementary services, specified in ISO/IEC 11582 [13] for an End PINX, shall apply for receiving or sending TETRA specific messages or TETRA information complementary to PSS1 basic call messages. Such messages or complementary information shall be encoded as ROSE operation Invoke APDUs in facility information elements. Notably, the encoded APDUs shall be sent in facility information elements in the PSS1 CONNECT messages.

### 6.2.1.4 Requirements on the participating SwMI

#### 6.2.1.4.1 PSS1 DISCONNECT or PSS1 RELEASE COMPLETE message

The participating SwMI shall release the call related connection to the controlling SwMI when the participating SwMI cannot accept the incoming group call. A PSS1 RELEASE COMPLETE message shall be sent to the controlling SwMI when no PSS1 message previously has been sent in response to the PSS1 SETUP message. Otherwise a PSS1 DISCONNECT message is sent. The following rules shall apply for the cause information element of the PSS1 DISCONNECT or PSS1 RELEASE COMPLETE message:

- the location area shall be set to private network serving the local user.

#### 6.2.1.4.2 PSS1 CONNECT message

The participating SwMI shall invoke an ANF-ISIGC entity to support call establishment and call clearing procedures as for a terminating PINX, as specified in ISO/IEC 11572 [11]. When the participating SwMI is aware that the called group can be connected, a PSS1 CONNECT message shall be sent to the controlling SwMI as a response to the PSS1 SETUP message. The following rules shall apply for the contents of the connected number and connected subaddress information elements in the PSS1 CONNECT message:

- the connected number information element shall be included. The connected number shall correspond to the connected number received in the PSS1 SETUP message. The connected numbering plan identification shall be equal to either private numbering plan or unknown. No presentation or screening indicators shall be included (i.e. the connected information element shall not include octet 3a);
- no connected party subaddress information element shall be included;
- no progress indicator should be included, since no tones or announcements are sent, and it shall not be considered that an interworking situation occurs for inter-TETRA group calls. For the same reason, no PSS1 PROGRESS message should be sent;
- the channel indication information element may indicate a new information channel as described in clause 10.1.2 of ISO/IEC 11572 [11].

Generic procedures for the call related control of supplementary services, specified in ISO/IEC 11582 [13] for an End PINX, shall apply for receiving or sending TETRA specific messages or TETRA information complementary to PSS1 basic call messages. Such messages or complementary information shall be encoded as ROSE operation Invoke APDUs in facility information elements. Notably, the encoded APDUs shall be sent in facility information elements in the PSS1 CONNECT messages.

#### 6.2.1.5 Requirements on the originating SwMI with PSTN/ISDN/PISN incoming gateway

##### 6.2.1.5.1 PSS1 SETUP message

The originating SwMI shall invoke an ANF-ISIGC entity to support call establishment and call clearing procedures as for an incoming gateway PINX, as specified in ISO/IEC 11572 [11]. In addition, the following rules shall apply for the information elements of the PSS1 SETUP message:

- the sending complete information element shall be included. The complete called number shall always be sent from the originating SwMI in the forward group call set-up request;
- the bearer capability information element shall be encoded with information transfer capability equal to unrestricted digital information, and an information transfer rate equal to 64 kbit/s;
- one, two or three progress indicator information elements shall be included, depending on network sending the SETUP message. The following rules shall apply for the progress indicator numbers for the different networks:
  - for a PSTN call the following progress description numbers shall be used:
    - a ITU-T progress description number 1 "call is not end-to-end ISDN, further call progress information may be available in-band";
    - an ISO/IEC progress description number 16 "interworking with a public network"; and
    - if the PSTN access line interface used at the gateway cannot deliver a release signal (e.g. standard PSTN extension line - with no battery reversal signal), an ISO/IEC progress description number 17 "interworking with a network unable to supply a release signal" (or an ISO/IEC progress description number 18 or 19, depending on whether it can supply a release signal after answer, but not before, or before answer, but not after);
  - for a public ISDN call an ISO/IEC progress description number 16 "interworking with a public ISDN" shall be used; and



- for a PISN call an ECMA progress description number 20 "interworking with a another private network" shall be used;
- the calling party number information element shall be included. The corresponding number shall be a PISN number identifying the gateway SwMI or one of its entities. Thus its numbering plan identification shall be equal to either private numbering plan or unknown. No presentation or screening indicators shall be included (i.e. the calling party information element shall not include octet 3a);

NOTE 1: The type of number associated to the calling party number information element is defined as shown in table 26 of ISO/IEC 11572 [11].

NOTE 2: The calling party identity (identity identifying the calling user) is part of the complementary TETRA forward information (see table 24).

- no calling party subaddress information element shall be included;
- the number included in the called party number information element shall be a PISN number received from a PSTN, public ISDN or PISN network identifying the called group's home SwMI or the controlling SwMI or one of its entities. The PISN number for the controlling SwMI shall be used when the call has been re-routed. Thus its numbering plan identification shall be equal to either private numbering plan or unknown;

NOTE 3: The type of number associated to the called party number information element is defined as shown in table 26 of ISO/IEC 11572 [11].

- no called party subaddress information element shall be included;
- no lower layer or high layer compatibility information elements shall be included; and
- the transit counter information element, defined in EN 300 172 [1], may be included.

Generic procedures for the call related control of supplementary services, specified in ISO/IEC 11582 [13] for an originating PINX, shall apply for sending or receiving TETRA specific messages or TETRA information complementary to PSS1 basic call messages. Such messages or complementary information shall be encoded as ROSE operation Invoke APDUs in facility information elements. Notably, the encoded APDUs shall be sent in facility information element in the PSS1 SETUP message.

## 6.2.2 PISN connection oriented, call independent connection

A PISN connection oriented, call independent connection shall be used when a call restoration request is received from a participating SwMI. The PISN connection may be a connection that is already established or a new PISN connection.

When the call independent connection is a new PISN connection, the controlling SwMI shall then invoke an ANF-ISIGC entity to support the connection oriented call unrelated connection. The invoked ANF-ISIGC entity shall support call unrelated establishment and clearing procedures as for an originating PINX, as specified in ISO/IEC 11582 [13] (clause 7.3.1). In addition, the following rules shall apply for the information elements of the PSS1 SETUP message:

- the sending complete information element shall be included when the called party number is complete;

NOTE 1: Although it is expected that the called party number be sent en-bloc, the use of (PISN) overlap sending (see clauses 10.1.1, 10.1.3 and 10.1.4 of ISO/IEC 11572 [11] for the corresponding descriptions) is not prevented by the present document.

- no progress indicator information element shall be included;
- the calling party number information element shall be included. The corresponding number shall be a PISN number identifying either the migrated user's home SwMI, the old visiting SwMI or the group home SwMI, or one of its entities. Thus its numbering plan identification shall be equal to either private numbering plan or unknown. No presentation or screening indicators shall be included (i.e. the calling party information element shall not include octet 3a);

NOTE 2: The type of number associated to the calling party number information element is defined as shown in table 26 of ISO/IEC 11572 [11].

NOTE 3: The restoring party identity (identity identifying the migrated user) is part of the complementary TETRA restore information (see table 49).

- no calling party subaddress information element shall be included;
- the number included in the called party number information element shall be a PISN number identifying either the old visiting SwMI or the controlling SwMI, or one of its entities. Thus its numbering plan identification shall be equal to either private numbering plan or unknown;

NOTE 4: The type of number associated to the called party number information element is defined as shown in table 26 of ISO/IEC 11572 [11].

- no called party subaddress information element shall be included;
- no lower layer or high layer compatibility information elements shall be included;
- and the transit counter information element, defined in EN 300 172 [1], may be included.

Generic procedures for call independent signalling of supplementary services to and from an End PINX, specified in ISO/IEC 11582 [13], shall apply for sending or receiving TETRA specific messages or TETRA information complementary to PSS1 basic call messages. Such messages or complementary information shall be encoded as ROSE operation Invoke APDUs in facility information elements. Notably, the encoded APDUs shall be sent in facility information elements in the PSS1 SETUP message.

## 6.3 ANF-ISIGC coding requirements

TETRA specific messages or TETRA information complementary to PSS1 basic call messages shall be sent using an Invoke APDU of the ROSE operation tetraIsiMessage defined in table 10 of EN 300 392-3-1 [4]. This table has been reproduced in the informative annex D.

More precisely:

- the TETRA specific messages or TETRA information complementary to PSS1 basic call messages shall be the TETRA PDUs defined in clause 6.3.1; and
- those PDUs shall be included in the tetraMessage data element of the ROSE operation tetraIsiMessage.

The resulting ROSE APDU shall be sent in a facility information element in the relevant PSS1 message (see ISO/IEC 11582 [13] clause 10).

### 6.3.1 TETRA ANF-ISIGC PDUs

The information contained in the following PDU descriptions shall be encoded using the same rule as defined in clause 14.7 of EN 300 392-2 [3] (for TETRA air interface PDUs).

NOTE: Even when only one TETRA PDU type has been defined for inclusion in a given PSS1 message (e.g. in the CONNECT ACK message), the information element PDU type has been included in this TETRA PDU. The reason for this, is to allow the possibility of defining other TETRA PDU types in the same PSS1 message in the future. Additionally it might ease the processing of these PDUs by the destination SwMI call control application.

The definitions of all possible TETRA PDUs, in the various PSS1 messages, are given in clauses 6.3.1.1 and 6.3.1.2.

### 6.3.1.1 PISN connection oriented call related connection

#### 6.3.1.1.1 TETRA PDU giving complementary information in the PSS1 SETUP, PSS1 CONNECT or PSS1 FACILITY message

##### 6.3.1.1.1.1 TETRA PDU sent by the originating SwMI - used to forward a call set-up request

The contents and the encoding of the TETRA PDU giving complementary information in the PSS1 SETUP or PSS1 FACILITY message sent by the originating SwMI shall be as defined in table 24.

The ISI-ORIGINATING-SETUP PDU may be sent at any phase of the call to indicate to the CSwMI that there is a new calling subscriber. A SwMI that sends an ISI-ORIGINATING-SETUP PDU before the call is connected is, or becomes, an OSwMI. A SwMI that is already an OSwMI is not required to send further ISI-ORIGINATING-SETUP PDUs when other calling parties appear, but may send them if it wishes. Once the call setup has started, but the call has not yet been connected a PswMI shall send in an ISI-ORIGINATING-SETUP PDU when a new calling subscriber appears. Once the call has connected, there is no requirement for any PswMI to send any ISI-ORIGINATING-SETUP PDUs, however an implementation may send them if it wishes.

**Table 24: Contents of TETRA PDU in the PSS1 SETUP message sent by the originating SwMI**

Information element	Length	Type	Owner	C/O/M	Remark
PDU type	6	1	CCAp	M	ISI-ORIGINATING SETUP
Selected area number	8	1	ANF	M	
Originating SwMI MNI	24	1	ANF	M	
Calling group type identifier	1	1	ANF	M	
Calling group MNI	24		ANF	C	See note 10
Calling group SSI	24		ANF	C	See note 10
Basic service information	8	1	CCAp	M	
Speech service requested	3		CCAp	C	See note 1
Security level at air interface	2	1	MM	M	
Request to transmit/send data	1	1	CCAp	M	
Call priority	4	1	CCAp	M	
Called party SSI	24	1	CCAp	M	See note 2
Called party extension	24	1	CCAp	M	See note 2
SS-CLIR invoked for calling party	1	1	SS	M	
Group attachment indicator	1	1	CCAp	M	See note 3
Calling party SSI	24	1	CCAp	M	See note 4
Calling party extension	24	1	CCAp	M	See note 4
External subscriber number length	5	1	CCAp	M	See note 5
External subscriber number digits	variable		CCAp	C	See note 6
External subscriber number parameters	12		CCAp	C	See note 7
Speech services supported	5	2	CCAp	O	See note 9
Notification indicator	6	2	SS	O	
Proprietary		3	-	O	
<p>NOTE 1: Conditional on the binary value of the information sub-element 'circuit mode type' in the information element 'basic service information' being equal to 0 (i.e. the call requested is a speech call).</p> <p>NOTE 2: This element shall always indicate the actual called group identity and not a possible linked group identity if the called group is linked.</p> <p>NOTE 3: This information element shall indicate whether the calling user is attached to the called group in the visited SwMI.</p> <p>NOTE 4: In the case of an external incoming call, the calling party SSI and the calling party extension shall be those of the incoming gateway SwMI.</p> <p>NOTE 5: Shall be equal to 00000<sub>2</sub> in the case of inter-TETRA calls, and to N, N being the number of digits of the external calling party number in the case of an external incoming call from PSTN/ISDN/PISN if the calling party identification is delivered by that external network.</p> <p>NOTE 6: The number of digits included in this information element shall be equal to N, the value of the external subscriber number length (see note 5), i.e. this information element shall be conditional on the value of N.</p> <p>NOTE 7: This information element shall be present only when the external subscriber number length value N is not 00000<sub>2</sub>.</p> <p>NOTE 8: Void.</p> <p>NOTE 9: This element enables future additions to the TETRA air interface CODEC. This information element is not supported in the first edition of the present document.</p> <p>NOTE 10: This information element shall be present only when the Calling group type identifier information element is set to 'Calling group GTSI present'.</p>					

NOTE 1: The originating group MNI and SSI has been included in the definition of the TETRA PDU in table 24 to ease the identification of the originating group by the group home SwMI or by the linking controlling SwMI.

NOTE 2: The originating SwMI MNI has been included in the definition of the TETRA PDU in table 24 to ease the identification of the originating SwMI by the group home SwMI or by the linking controlling SwMI.

The SwMI MNI identifications are necessary:

- for enforcing security mechanisms agreed between operators; or
- to identify whether or not a proprietary feature can be used over the ISI.

### 6.3.1.1.1.2 TETRA PDU sent by the controlling SwMI - used for setting up a group call

The contents and the encoding of the TETRA PDU giving complementary information in the PSS1 SETUP, PSS1 CONNECT, PSS1 DISCONNECT or PSS1 FACILITY message sent by the controlling SwMI shall be as defined in table 25.

The ISI-SETUP-INITIATE PDU is sent by a CSwMI during call setup to O/PSwMIs that are part of the call. The ISI-SETUP-INITIATE PDU is sent as a response to the first ISI-ORIGINATING-SETUP PDU received for a call and as the first PDU sent to all of the PSwMIs in the group call. In the first use of ISI-SETUP-INITIATE PDU in a call, the ISI-SETUP-INITIATE PDU is sent to all SwMIs in the call. Subsequent ISI-ORIGINATING-SETUP PDUs on the existing PSS1 connection for the call are not responded to with ISI-SETUP-INITIATE PDU. However, if the ISI-ORIGINATING-SETUP PDUs come in to the CSwMI on a new PSS1 connection an ISI-SETUP-INITIATE PDU is sent in response.

Before the call is connected, a CSwMI may send out further ISI-SETUP-INITIATE PDUs. It does this after the call setup has been delayed, by the CSwMI, and it then decides to try to set the call up again. In this case ISI-SETUP-INITIATE PDU can only be sent to SwMIs that have previously been sent ISI-RELEASE PDU (delay group call setup). SwMIs that are still delaying themselves and have not yet sent in an ISI-SETUP-ACKNOWLEDGE PDU shall not send an ISI-SETUP-INITIATE PDU.

An ISI-SETUP-INITIATE PDU is sent to any OSwMI, not currently in the call, that sends in an ISI-ORIGINATING-SETUP PDU to the existing group, this can occur in any phase of the call.

During the maintenance phase of the call, a CSwMI may use an ISI-SETUP-INITIATE PDU to bring in any new PSwMI into the call. This is "late entry" of a PSwMI into the call.

The ISI-Setup-Initiate can be sent in a PSS1 Disconnect in the case of a new calling party appearing at an OSwMI or a PSwMI. The PSS1 connection being used by the ISI-Originating-Setup sent as a result of the new calling party is being closed down and the PSS1 Connection being used by the existing call is used from now on.

**Table 25: Contents of TETRA PDU in the PSS1 SETUP, PSS1 CONNECT, PSS1 DISCONNECT or PSS1 FACILITY message sent by the controlling SwMI**

Information element	Length	Type	Owner	C/O/M	Remark
PDU type	6	1	CCAp	M	ISI-SETUP INITIATE
Selected area number	8	1	ANF	M	
Controlling SwMI MNI	24	1	ANF	M	
Linking group type identifier	1	1	ANF	M	
Linking group SSI	24		ANF	C	See note 15
Linking group MNI	24		ANF	C	See note 15
Originating SwMI MNI	24	1	ANF	M	
Call time-out	4	1	CCAp	M	
Basic service information	8	1	CCAp	M	
Speech service chosen	3		CCAp	C	See note 1
Security level at air interface	2	1	MM	M	See note 16
Call priority	4	1	CCAp	M	
Call ownership	1	1	CCAp	M	
SS-COLR invoked for connected group	1	1	SS	M	
Connected party SSI	24	1	CCAp	M	
Connected party extension	24	1	CCAp	M	
Number of external group member identities	4	1	CCAp	M	
External group member identity	variable		CCAp	C	See note 3
SS-CLIR invoked for calling party	1	1	SS	M	
Calling party SSI	24	1	CCAp	M	See notes 4 and 5
Calling party extension	24	1	CCAp	M	See notes 4 and 5
External subscriber number length	5	1	CCAp	M	See note 6
External subscriber number digits	variable		CCAp	C	See note 7
External subscriber number parameters	12		CCAp	C	See note 8
Temporary group member indication	1	1	CCAp	M	See note 9
Temporary group basic migration profile	variable		CCAp	C	See note 10
SS-migration profile	variable		SS	C	See note 11
Dispatcher acceptance	1	1	SS	M	See note 12
Call amalgamation	1	1	CCAp	M	

Information element	Length	Type	Owner	C/O/M	Remark
Number of critical users	4	1	CCAp	M	See note 13
Critical user list	variable		CCAp	C	See note 14
Setup response time-out	4	1	CCAp	M	See note 17
Notification indicator	6	2	SS	O	
Proprietary		3	-	O	
<p>NOTE 1: Conditional on the binary value of the information sub-element "circuit mode type" in the information element "basic service information" being equal to 0 (i.e. the call requested is a speech call).</p> <p>NOTE 2: Void.</p> <p>NOTE 3: This information element is repeatable and conditional on the information element 'Number of external group member identities'.</p> <p>NOTE 4: The calling party identity is used by the originating SwMI to identify the calling user.</p> <p>NOTE 5: In the case of an external incoming call, the calling party SSI and the calling party extension shall be those of the incoming gateway SwMI. The calling party extension is conditional on the calling party type identifier.</p> <p>NOTE 6: Shall be equal to 00000<sub>2</sub> in the case of inter-TETRA calls, and to N, N being the number of digits of the external calling party number in the case of an external incoming call from PSTN/ISDN/PISN if the calling party identification is delivered by that external network.</p> <p>NOTE 7: The number of digits included in this information element shall be equal to N, the value of the external subscriber number length (see note 6), i.e. this information element shall be conditional on the value of N.</p> <p>NOTE 8: This information element shall be present only when the external subscriber number length value N is not 00000<sub>2</sub>.</p> <p>NOTE 9: Indication to the originating SwMI that the calling user is temporarily a member of the called group.</p> <p>NOTE 10: Depending on the value of temporary group member indication. The profile shall reflect the actual call being connected.</p> <p>NOTE 11: Depending on the value of temporary group member indication. The contents of SS-ISI PROFILE shall be as defined, if applicable, for the supplementary service in each supplementary service sub-part of EN/ETS 300 392-12 [9].</p> <p>NOTE 12: The information element is set when SS-CAD has been invoked for a call and the dispatcher has accepted the call set-up. The information element is used to prevent subsequent invocations of SS-CAD.</p> <p>NOTE 13: Equal to 0 when no critical users are identified for the group call.</p> <p>NOTE 14: This information element shall be conditional on the information element "Number of critical users" when this value differs from 0. Shall be repeated as a set according to the value of the information element "Number of critical users" when this value is larger than 1.</p> <p>NOTE 15: This information element shall be present as defined by the Linking group type identifier information element is set to "Linking group GTSI present".</p> <p>NOTE 16: Security level requested by the CSwMI.</p> <p>NOTE 17: Refer to clause 4.2.2.3.4.</p>					

NOTE 1: The controlling group SSI has been included in the definition of the TETRA PDU in table 25 to ease the identification of the controlling group by the participating SwMI. The controlling group MNI is the same as the controlling SwMI MNI.

NOTE 2: The originating SwMI MNI has been included in the definition of the TETRA PDU in table 25 to ease the identification of the originating SwMI by the controlling SwMI.

The SwMI MNI identifications are necessary:

- for enforcing security mechanisms agreed between operators; or
- to identify whether or not a proprietary feature can be used over the ISI.

The calling party SSI and extension shall correspond to the transmitting party when call set-up is initiated by the controlling SwMI towards SwMI(s) currently not participating in the active group call.

### 6.3.1.1.2 TETRA PDU giving complementary information in the PSS1 CONNECT or PSS1 FACILITY message

#### 6.3.1.1.2.1 TETRA PDU sent by the controlling SwMI - used to send call information

When a forward group call request has been queued or the controlling SwMI wishes to inform the originating SwMI of call time-out for the set-up phase before group call set-up, the PSS1 CONNECT message shall include a TETRA PDU. The contents and the encoding of this TETRA PDU shall be as defined in table 26.

**Table 26: Contents of TETRA PDU sent in the PSS1 CONNECT message sent by the controlling SwMI**

Information element	Length	Type	Owner	C/O/M	Remark
PDU type	6	1	CCAp	M	ISI-INFO
ISI-INFO type	3	1	CCAp	M	From CSwMI, to OSwMI only
Call time-out, set-up phase	3	2	CCAp	O	
Call status	3	2	CCAp	O	
Notification indicator	6	2	SS	O	
Proprietary		3	-	O	

#### 6.3.1.1.2.2 TETRA PDU sent by the originating or a participating SwMI - used as a call set-up response

To acknowledge the TETRA PDU (ISI-SETUP INITIATE), the originating SwMI and participating SwMI(s) shall send an ISI-SETUP ACKNOWLEDGE PDU. By sending this TETRA PDU the originating and participating SwMI(s) confirms that air interface, mobile and infrastructure resources are available for connecting the called group.

This PDU shall be sent in a PSS1 CONNECT or PSS1 FACILITY message. The contents and the encoding of which shall be as defined in table 27.

The ISI-SETUP-ACKNOWLEDGE PDU is sent from an O/PSwMI when it is ready to receive an ISI-CONNECT PDU from the CSwMI. The reasons used by an O/PSwMI to send in the ISI-SETUP-ACKNOWLEDGE PDU are flexible. The recommended strategy is for the CSwMI to send its ISI-SETUP-ACKNOWLEDGE PDU when it has resources to connect a calling party into the call. The recommended strategy for a PSwMI is for the ISI-SETUP-ACKNOWLEDGE PDU to be sent when it has determined that group party members are present on the SwMI.

The ISI-SETUP-ACKNOWLEDGE PDU is sent by a P/OSwMI in response to an ISI-SETUP-INITIATE PDU. If the receiving SwMI is not immediately able to respond to the ISI-SETUP-INITIATE PDU (because the SwMI is not yet ready to receive an ISI-CONNECT PDU) the SwMI must first have sent an ISI-DELAY PDU to the CSwMI.

An ISI-SETUP-ACKNOWLEDGE PDU may be sent when an ISI-INFO PDU is received, if the receiving SwMI is delaying, the call is connecting and the SwMI want to be connected into the call.

The conditional fields are required to tell the CSwMI details about a calling party that is eligible to be the calling party of the call (and thus be granted talk permission, if it is the calling party of the call on connection). The conditional fields are used by an OSwMI; a PSwMI never uses them.

**Table 27: Contents of TETRA PDU sent in a PSS1 CONNECT or PSS1 FACILITY message**

Information element	Length	Type	Owner	C/O/M	Remark
PDU type	6	1	CCAp	M	ISI-SETUP ACKNOWLEDGE
Basic service information	8	1	CCAp	M	See note 1
Resource allocation	1	1	ANF	M	
Call resource time	3	1	CCAp	M	
Security level at air interface	2	1	CCAp	M	
Group call SwMI type	1	1	CCAp	M	
Speech service requested	3		CCAp	C	See notes 2 and 3
Request to transmit/send data	1		CCAp	C	See note 2
Call priority	4		CCAp	C	See note 2
SS-CLIR invoked for calling party	1		SS	C	See note 2
Group attachment indicator	1		CCAp	C	See notes 2 and 4
Calling party SSI	24		CCAp	C	See notes 2 and 5
Calling party extension	24		CCAp	C	See notes 2 and 5
Calling external subscriber number length	5		CCAp	C	See notes 2 and 6
Calling external subscriber number digits	variable		CCAp	C	See note 7
Calling external subscriber number parameters	12		CCAp	C	See note 8
Speech services supported	5	2	CCAp	O	See note 9
Notification indicator	6	2	SS	O	
Proprietary		3	-	O	
NOTE 1: The binary value of the information sub-element communication type in the information element basic service information may be changed from the value received in either ISI-SETUP INITIATE. The new value shall indicate the communication type supported by the SwMI, if the received value is not supported. All other sub-elements shall be returned unchanged.					
NOTE 2: Conditional on the value of the information sub-element "Group call SwMI type" being equal to "From Originating SwMI".					
NOTE 3: Conditional on the binary value of the information sub-element "circuit mode type" in the information element "basic service information" being equal to 0 (i.e. the call requested is a speech call).					
NOTE 4: This information element shall indicate whether the calling user is attached to the called group in the visited SwMI.					
NOTE 5: In the case of an external incoming call, the calling party SSI and the calling party extension shall be those of the incoming gateway SwMI.					
NOTE 6: Shall be equal to 00000 <sub>2</sub> in the case of inter-TETRA calls, and to N, N being the number of digits of the external calling party number in the case of an external incoming call from PSTN/ISDN/PISN if the calling party identification is delivered by that external network.					
NOTE 7: The number of digits included in this information element shall be equal to N, the value of the external subscriber number length (see note 5), i.e. this information element shall be conditional on the value of N.					
NOTE 8: This information element shall be present only when the external subscriber number length value N is not 00000 <sub>2</sub> .					
NOTE 9: This element enables future additions to the TETRA air interface CODEC and may be present only if the value of the information sub-element "Group call SwMI type" is equal to "From Originating SwMI". This information element is not supported in the first edition of the present document.					

### 6.3.1.1.2.3 TETRA PDU sent by the originating or a participating SwMI - used to delay call set-up

When the originating or a participating SwMI wishes to delay call set-up, the following TETRA PDU shall be returned to the controlling SwMI. The TETRA PDU may be returned in either PSS1 CONNECT PDU or in PSS1 Facility PDU. The contents and the encoding of this TETRA PDU shall be as defined in table 28.

When the originating or a participating SwMI wishes to delay call set-up, the PSS1 CONNECT or PSS1 FACILITY message shall be returned to the controlling SwMI with the following TETRA PDU. The contents and the encoding of this TETRA PDU shall be as defined in table 28.

The ISI-DELAY PDU shall be sent from an O/PSwMI in response to an ISI-SETUP-INITIATE PDU, when it has been determined that an ISI-SETUP-ACKNOWLEDGE PDU cannot be immediately sent (because the SwMI is not yet ready to receive an ISI-CONNECT PDU). If the ISI-SETUP-ACKNOWLEDGE PDU is immediately available to be sent, then it is sent and no ISI-DELAY PDU is used.



**Table 28: Contents of TETRA PDU sent in a PSS1 CONNECT or in a PSS1 FACILITY message sent by the originating or a participating SwMI**

Information element	Length	Type	Owner	C/O/M	Remark
PDU Type	6	1	CCAp	M	ISI-DELAY
Notification indicator	6	2	SS	O	
Proprietary		3	-	O	

### 6.3.1.1.3 TETRA PDU giving complementary information in the PSS1 FACILITY message

#### 6.3.1.1.3.1 TETRA PDU sent by the controlling SwMI - used for connecting the call

The contents and the encoding of the TETRA PDU giving complementary information in the PSS1 FACILITY message sent by the controlling SwMI shall be as defined in table 29.

The ISI-CONNECT PDU is sent, by the CSwMI, to connect the call and take the call into the maintenance phase from the call setup phase. When the ISI-CONNECT PDU is sent to all of the SwMIs in the call this is called a "complete" connect, when it is sent to only some of the SwMIs in the group call this is called a "partial" connect. An ISI-CONNECT PDU can only be sent to a SwMI that last sent in an ISI-SETUP-ACKNOWLEDGE PDU.

The CSwMI determines when the call can be connected based on the evidence available to it, both locally, and from the SwMIs in the call. The actual strategy used by the CSwMI to determine when to connect is flexible and therefore implementation dependent. The recommended strategy is for the CSwMI to connect the call when it has an OSwMI (or local calling party) that has sent in an ISI-SETUP-ACKNOWLEDGE PDU and is thus ready to be connected into the call.

Once the call has been connected, the arrival of an ISI-SETUP-ACKNOWLEDGE PDU at the CSwMI will be responded to by an ISI-CONNECT PDU.

**Table 29: Contents of TETRA PDU in the PSS1 FACILITY message sent by the controlling SwMI**

Information element	Length	Type	Owner	C/O/M	Remark
PDU type	6	1	CCAp	M	ISI-CONNECT
Set-up type	1	1	CCAp	M	
Transmission grant	2	1	ANF	M	
Transmission request permission	1	1	CCAp	M	
Call diverted to dispatcher	1	1	SS	M	See note 1
Security level at air interface	2	1	MM	M	See note 8
Basic service information	8	1	CCAp	M	
Call priority	4	1	CCAp	M	See note 2
Call ownership	1	1	CCAp	M	
Calling party information present	1	1	CCAp	M	
Calling party SSI	24		CCAp	C	See notes 3 and 4
Calling party extension	24		CCAp	C	See notes 3 and 4
Calling external subscriber number length	5		CCAp	C	See notes 3 and 5
Calling external subscriber number digits	Variable		CCAp	C	See note 6
Call external subscriber number parameters	12		CCAp	C	See note 7
SS-CLIR invoked for calling party	1		SS	C	See note 3
Notification indicator	6	2	SS	O	
Proprietary		3	-	O	
<p>NOTE 1: This indication shall be used to indicate direct call set-up to a dispatcher.</p> <p>NOTE 2: The value of the call priority information element may change due to call amalgamation.</p> <p>NOTE 3: Conditional on the value of the "Calling party information present" information element.</p> <p>NOTE 4: In the case of an external incoming call, the calling party SSI and the calling party extension shall be those of the incoming gateway SwMI.</p> <p>NOTE 5: Shall be equal to 00000<sub>2</sub> in the case of inter-TETRA calls, and to N, N being the number of digits of the external calling party number in the case of an external incoming call from PSTN/ISDN/PISN if the calling party identification is delivered by that external network.</p> <p>NOTE 6: Conditional on the information element "External subscriber number digits" &gt; 0. Where present the number of digits is equal to N, the value of the information element "External subscriber number length".</p> <p>NOTE 7: Conditional on the information element "External subscriber number digits" &gt; 0.</p> <p>NOTE 8: Security level required by the CSwMI.</p>					

Upon reception of this TETRA PDU the originating SwMI shall connect the calling user(s) (D\_CONNECT PDU sent over the air interface). The originating SwMI's status shall then change from an originating SwMI to a participating SwMI and the called user(s) shall be connected to the group call (a D-SETUP PDU is sent over the air interface).

The participating SwMI(s) shall connect the called user(s) upon reception of this TETRA PDU (a D-SETUP PDU is sent over the air interface).

When a group call is connected (ISI-CONNECT sent to the originating and participating SwMI(s)), only the calling user, identified in the PDU, shall receive transmission permission. If transmission is not granted to the calling user during call set-up, transmission shall only be granted to another user participating in the group call, upon request for transmission from that user.

When several group calls are amalgamated, more than one calling user shall exist. Therefore, it shall be up to the controlling SwMI to decide which calling user shall receive transmission grant, if any.

When two or more calls are amalgamated call ownership is not given to a calling user. The controlling SwMI shall become the call owner.

### 6.3.1.1.3.2 TETRA PDU sent by the controlling SwMI - used for polling

The contents and the encoding of the TETRA PDU giving complementary information in the PSS1 FACILITY message sent by the controlling SwMI shall be as defined in table 30.

**Table 30: Contents of TETRA PDU sent in the PSS1 FACILITY message sent by the controlling SwMI**

Information element	Length	Type	Owner	C/O/M	Remark
PDU Type	6	1	CCAp	M	ISI-POLL USER
Poll request type	1	1	CCAp	M	
Notification indicator	6	2	SS	O	
Proprietary		3	-	O	

### TETRA PDU sent by a participating SwMI - used as a polling response

The contents and the encoding of the TETRA PDU giving complementary information in the PSS1 FACILITY message sent by a participating SwMI shall be as defined in table 31.

**Table 31: Contents of TETRA PDU sent in the PSS1 FACILITY message sent by a participating SwMI**

Information element	Length	Type	Owner	C/O/M	Remark
PDU Type	6	1	CCAp	M	ISI-POLL RESPONSE
Poll request type	1	1	CCAp	M	
Poll response number	6		CCAp	C	See note
Poll response percentage	6		CCAp	C	See note
Notification indicator	6	2	SS	O	
Poll response addresses		3	CCAp	O	
Proprietary		3	-	O	
NOTE: Conditional on the chosen value of the information element poll request type.					

### 6.3.1.1.3.3 TETRA PDU sent by the controlling SwMI - used to send call information

When the controlling SwMI wishes to inform participating SwMI(s) (and the originating SwMI if it exist) of changed or updated group call information, the PSS1 FACILITY message shall be sent containing a TETRA PDU. The contents and the encoding of this TETRA PDU shall be as defined in table 32.

The ISI-INFO PDU may be sent to a delaying SwMI when the CSwMI connects the call. A delaying SwMI is one that has been sent an ISI-SETUP-INITIATE PDU by the CSwMI, which responded with an ISI-DELAY PDU but has not yet sent an ISI-SETUP-ACKNOWLEDGE PDU. In this case, the only optional part of the PDU present will be the "call status" field, which will be encoded as "Call connected". The receiving SwMI may choose to expedite the return of its ISI-SETUP-ACKNOWLEDGE PDU so that it may be connected into the call.

**Table 32: Contents of TETRA PDU sent in the PSS1 FACILITY message used to send call information**

Information element	Length	Type	Owner	C/O/M	Remark
PDU type	6	1	CCAp	M	ISI-INFO
ISI-INFO type	3	1	CCAp	M	From CSwMI, updated group information
Reset call time-out timer (T310)	1	1	CCAp	M	
Call time-out	4	2	CCAp	O	
Basic service information	8	2	CCAp	O	
Call status	3	2	CCAp	O	
Call ownership	1	2	CCAp	O	
Poll result identifier	1	2	CCAp	O	See note 1
Poll response percentage	6		CCAp	C	See note 2
Poll response number	6		CCAp	C	See note 2
Group information	2	2	CCAp	O	
Critical connected party SSI	24		CCAp	C	See note 3
Critical connected party extension	24		CCAp	C	See note 3
Notification indicator	6	2	SS	O	
DTMF digits		3	CCAp	O	
Proprietary		3	-	O	
NOTE 1: Shall be valid for acknowledge group calls only. For other types of calls it shall be set to 0.					
NOTE 2: Depending on the value of poll result identifier.					
NOTE 3: Conditional on the information element Group information is set to value "Call not established to critical party".					

#### 6.3.1.1.3.4 TETRA PDU sent by a participating SwMI - used to send call information

When a participating SwMI wishes to inform the controlling SwMI of changed call identifier or DTMF digits, the PSS1 FACILITY message shall be sent containing the TETRA PDU below. The contents and the encoding of this TETRA PDU shall be as defined in table 33.

**Table 33: Contents of TETRA PDU sent in the PSS1 FACILITY message used to send call information**

Information element	Length	Type	Owner	C/O/M	Remark
PDU type	6	1	CCAp	M	ISI-INFO
ISI-INFO type	3	1	CCAp	M	From PswMI
Resource allocation	1	1	ANF	O	See note
Notification indicator	6	2	SS	O	
DTMF digits		3	CCAp	O	
Proprietary		3	-	O	
NOTE: Used during call restoration to indicate a change in resource allocation.					

### 6.3.1.1.3.5 TETRA PDU sent by the originating or a participating SwMI - used to request transmission permission

To request transmission permission an ISI-TX DEMAND PDU shall be sent to the controlling SwMI. This PDU shall be sent in a PSS1 FACILITY message. The contents and the encoding of which shall be as defined in table 34.

The ISI-TX DEMAND PDU is sent from a PSwMI to the CSwMI, once the call is in its maintenance phase. It is an indication that the party recorded in the PDU wishes to speak.

**Table 34: Contents of TETRA PDU sent in a PSS1 FACILITY message to request transmission grant**

Information element	Length	Type	Owner	C/O/M	Remark
PDU Type	6	1	ANF	M	ISI-TX DEMAND
TX demand priority	2	1	ANF	M	
Encryption control	1	1	ANF	M	
SS-CLIR invoked for requesting party	1	1	SS	M	
Requesting party SSI	24	1	ANF	M	See note 2
Requesting party extension	24	1	ANF	M	See note 2
Requesting external subscriber number length	5	1	CCAp	M	See note 3
Requesting external subscriber number digits	variable		CCAp	C	See note 4
Requesting external subscriber number parameter	12		CCAp	C	See note 5
Notification indicator	6	2	SS	O	
Proprietary		3	-	O	
NOTE 1: Void.					
NOTE 2: If transmission is granted to an external user then this information element's 24 bits shall be set to 0 or to the gateway address.					
NOTE 3: Shall be equal to 00000 <sub>2</sub> in the case of inter-TETRA calls, and to N, N being the number of digits of the external calling party number in the case of an external incoming call from PSTN/ISDN/PISN if the calling party identification is delivered by that external network.					
NOTE 4: The number of digits included in this information element shall be equal to N, the value of the external subscriber number length (see note 3), i.e. this information element shall be conditional on the value of N.					
NOTE 5: This information element shall be present only when the external subscriber number length value N is not 00000 <sub>2</sub> .					

### 6.3.1.1.3.6 Void

**Table 35: Void**

### 6.3.1.1.3.7 TETRA PDU sent by the controlling SwMI - used to request reservation of resources

The following TETRA PDU is sent to SwMI(s) with temporary allocated resources, before transmission is granted to a user during the call maintenance phase. The SwMI shall upon reception of this PDU reserve the necessary air interface, mobile and infrastructure resources needed for transmission.

The contents and the encoding of the TETRA PDU giving complementary information in the PSS1 FACILITY message sent by the controlling SwMI shall be as defined in table 36.

**Table 36: Contents of TETRA PDU sent in the PSS1 FACILITY message sent by the controlling SwMI**

Information element	Length	Type	Owner	C/O/M	Remark
PDU Type	6	1	CCAp	M	ISI-RESOURCE
Notification indicator	6	2	SS	O	
Proprietary		3	-	O	

### 6.3.1.1.3.8 TETRA PDU sent by a participating SwMI - used as a resource response

This PDU shall indicate the result of resource reservation in a participating SwMI.

The contents and the encoding of the TETRA PDU giving complementary information in the PSS1 FACILITY message sent by a participating SwMI shall be as defined in table 37.

**Table 37: Contents of TETRA PDU sent in the PSS1 FACILITY message sent by a participating SwMI**

Information element	Length	Type	Owner	C/O/M	Remark
PDU Type	6	1	ANF	M	ISI-RESOURCE RESPONSE
Resource indicator	2	1	ANF	M	
Notification indicator	6	2	SS	O	
Proprietary		3	-	O	

### 6.3.1.1.3.9 TETRA PDU sent by the originating or a participating SwMI - used to request cease of transmission

To request cease of transmission, an ISI-TX CEASED PDU shall be sent to the controlling SwMI. The PDU shall be sent either to cease an ongoing transmission or to remove a transmission request from the transmission queue.

The ISI-TX CEASED PDU shall be sent in a PSS1 FACILITY message. The contents and the encoding of this PDU shall be as defined in table 38.

The ISI-TX CEASED PDU may be sent from a PSwMI to the CSwMI. It is used when a party that is talking, stops talking, or when a previous demand, that has not yet been granted is being removed.

The ISI-TX CEASED PDU may also be sent from the CSwMI to PSwMIs. In this case, the PDU indicates that the party recorded in the PDU has ceased to talk.

**Table 38: Contents of TETRA PDU sent in a PSS1 FACILITY message to request cease of transmission**

Information element	Length	Type	Owner	C/O/M	Remark
PDU Type	6	1	ANF	M	ISI-TX CEASED
Transmission ceased	1	1	ANF	M	See note 1
Transmission request permission	1	1	ANF	M	See note 2
Ceasing party SSI	24	1	ANF	M	See note 4
Ceasing party extension	24	1	ANF	M	See note 4
Ceasing external subscriber number length	5	1	CCAp	M	See note 5
Ceasing external subscriber number digits	variable		CCAp	C	See note 6
Ceasing external subscriber number parameter	12		CCAp	C	See note 7
Notification indicator	6	2	SS	O	
Proprietary		3	-	O	

NOTE 1: Used to indicate cause of TX ceased.

NOTE 2: Shall only be valid when this TETRA PDU has been sent from the controlling SwMI.

NOTE 3: Void.

NOTE 4: If transmission is granted to an external user then this information element's 24 bits shall be set to 0 or to the gateway address.

NOTE 5: Shall be equal to 00000<sub>2</sub> in the case of inter-TETRA calls, and to N, N being the number of digits of the external calling party number in the case of an external incoming call from PSTN/ISDN/PISN if the calling party identification is delivered by that external network.

NOTE 6: The number of digits included in this information element shall be equal to N, the value of the external subscriber number length (see note 5), i.e. this information element shall be conditional on the value of N.

NOTE 7: This information element shall be present only when the external subscriber number length value N is not 00000<sub>2</sub>.

### 6.3.1.1.3.10 TETRA PDU sent by the controlling SwMI - used to indicate cease of transmission

Indication sent from the controlling SwMI that transmission has been ceased. The PDU shall be sent to indicate that an ongoing transmission has been ceased. The contents and the encoding of the TETRA PDU giving complementary information in the PSS1 FACILITY message sent by the controlling SwMI shall be as defined in table 38.

### 6.3.1.1.3.11 TETRA PDU sent by the controlling SwMI - used to inform grant of transmission

This TETRA PDU is sent from the controlling SwMI when transmission has been granted to a requesting user. The PDU shall be sent in a PSS1 FACILITY message. The contents and the encoding of which shall be as defined in table 39.

The ISI-TX GRANTED PDU is sent from the CSwMI to PSwMIs, during call maintenance. It is used to indicate that:

- Talk permission has been granted to the party recorded in the PDU.
- Talk permission has been granted to another user, the granted party is recorded in the PDU.
- Talk permission has not been granted to the party recorded in the PDU.
- The request to talk, of the party recorded in the PDU, has been queued.

**Table 39: Contents of TETRA PDU sent in a PSS1 FACILITY message to grant transmission permission**

Information element	Length	Type	Owner	C/O/M	Remark
PDU Type	6	1	CCAp	M	ISI-TX GRANTED
Transmission grant	2	1	CCAp	M	
Transmission request permission	1	1	CCAp	M	
Encryption control	1	1	CCAp	M	
SS-CLIR invoked for transmitting party	1	1	SS	M	
Transmitting party SSI	24	1	CCAp	M	See note 1
Transmitting party extension	24	1	CCAp	M	See note 1
Transmitting external subscriber number length	5	1	CCAp	M	See note 2
Transmitting external subscriber number digits	variable		CCAp	C	See note 3
Transmitting external subscriber number parameter	12		CCAp	C	See note 4
Notification indicator	6	2	SS	O	
Proprietary		3	-	O	
NOTE 1: If transmission is granted to an external user then this information element's 24 bits shall be set to 0 or to the gateway address.					
NOTE 2: Shall be equal to 00000 <sub>2</sub> in the case of inter-TETRA calls, and to N, N being the number of digits of the external calling party number in the case of an external incoming call from PSTN/ISDN/PISN if the calling party identification is delivered by that external network.					
NOTE 3: The number of digits included in this information element shall be equal to N, the value of the external subscriber number length (see note 2), i.e. this information element shall be conditional on the value of N.					
NOTE 4: This information element shall be present only when the external subscriber number length value N is not 00000 <sub>2</sub> .					

The SwMI containing the granted user, shall send an individual addressed D-TX GRANTED PDU over the air interface to this user, upon reception of an ISI-TX GRANTED. A group addressed D-TX GRANTED PDU shall be sent to members of the group call upon reception of the ISI-TX GRANTED.

If transmission is granted to an external user then the Transmitting party information element may contain a dummy identifier "all zeros" or the actual gateway address.

### 6.3.1.1.3.12 TETRA PDU sent by the controlling SwMI - used to inform interruption of transmission

When a transmitting user is to be interrupted, the TETRA PDU ISI-TX INTERRUPT shall be sent to the originating SwMI and the participating SwMI(s). The PDU shall be sent in a PSS1 FACILITY message. The contents and the encoding of which shall be as defined in table 40.

The ISI-TX INTERRUPT PDU is used to indicate that, the party recorded in the PDU, has been allocated permission to talk. This is not the party that currently has talk permission.

**Table 40: Contents of TETRA PDU sent in a PSS1 FACILITY message to interrupt transmission**

Information element	Length	Type	Owner	C/O/M	Remark
PDU Type	6	1	CCAp	M	ISI-TX INTERRUPT
Transmission grant	2	1	CCAp	M	
Transmission request permission	1	1	CCAp	M	
Encryption control	1	1	CCAp	M	
SS-CLIR invoked for transmitting party	1	1	SS	M	
Transmitting party SSI	24	1	CCAp	M	See note 1
Transmitting party extension	24	1	CCAp	M	See note 1
Transmitting external subscriber number length	5	1	CCAp	M	See note 2
Transmitting external subscriber number digits	Variable		CCAp	C	See note 3
Transmitting external subscriber number parameter	12		CCAp	C	See note 4
Notification indicator	6	2	SS	O	
Proprietary		3	-	O	
NOTE 1: If transmission is granted to an external user then this information element's 24 bits shall be set to 0 or to the gateway address.					
NOTE 2: Shall be equal to 00000 <sub>2</sub> in the case of inter-TETRA calls, and to N, N being the number of digits of the external calling party number in the case of an external incoming call from PSTN/ISDN/PISN, if the calling party identification is delivered by that external network.					
NOTE 3: The number of digits included in this information element shall be equal to N, the value of the external subscriber number length (see note 2), i.e. this information element shall be conditional on the value of N.					
NOTE 4: This information element shall be present only when the external subscriber number length value N is not 00000 <sub>2</sub> .					

The SwMI containing the user currently transmitting, shall send an individual addressed D-TX INTERRUPT PDU over the air interface to this user, upon reception of an ISI-TX INTERRUPT. A group addressed D-TX INTERRUPT PDU should be sent to members of the group call upon reception of the ISI-TX INTERRUPT.

The SwMI containing the granted user, should send an individual addressed D-TX GRANTED PDU over the air interface to this user, after the group addressed D-TX INTERRUPT PDU has been sent.

### 6.3.1.1.3.13 TETRA PDU sent by a participating SwMI - used to inform of continuation in an active group call

When a participating SwMI continues with an active group call that it previously had withdrawn from, the controlling SwMI shall be informed. It is then up to the CC application of the controlling SwMI to determine if any actions shall be taken.

This PDU shall be sent in a PSS1 FACILITY message. The contents and the encoding of which shall be as defined in table 41.

**Table 41: Contents of TETRA PDU sent in a PSS1 FACILITY message by a participating SwMI**

Information element	Length	Type	Owner	C/O/M	Remark
PDU Type	6	1	CCAp	M	ISI-TX CONTINUE
Participating SwMI MNI	24	1	CCAp	M	
Notification indicator	6	2	SS	O	
Proprietary		3	-	O	



#### 6.3.1.1.3.14 TETRA PDU sent by a participating SwMI - used to inform of withdrawal from an active group call

When a participating SwMI withdraws from an active group call, the controlling SwMI shall be informed. It is then up to the CC application of the controlling SwMI to determine if any actions shall be taken.

This PDU shall be sent in a PSS1 FACILITY message. The contents and the encoding of which shall be as defined in table 42.

**Table 42: Contents of TETRA PDU sent in a PSS1 FACILITY message by a participating SwMI**

Information element	Length	Type	Owner	C/O/M	Remark
PDU Type	6	1	CCAp	M	ISI-TX WAIT
Participating SwMI MNI	24	1	CCAp	M	
Notification indicator	6	2	SS	O	
Proprietary		3	-	O	

#### 6.3.1.1.4 TETRA PDU giving complementary information in the PSS1 DISCONNECT or PSS1 FACILITY message

##### 6.3.1.1.4.1 TETRA PDU sent by the originating SwMI - used as a call set-up reject

When an ISI-SETUP INITIATE cannot be accepted by the originating SwMI, the PSS1 DISCONNECT message shall be returned to the controlling SwMI with the following TETRA PDU. The contents and the encoding of this TETRA PDU shall be as defined in table 43.

**Table 43: Contents of TETRA PDU sent in the PSS1 DISCONNECT message sent by the originating SwMI**

Information element	Length	Type	Owner	C/O/M	Remark
PDU Type	6	1	CCAp	M	ISI-REJECT
Reject cause	6	1	CCAp	M	
Notification indicator	6	2	SS	O	
Proprietary		3	-	O	

##### 6.3.1.1.4.2 TETRA PDU sent by the originating SwMI or a participating SwMI - used to disconnect from the call

The contents and the encoding of the TETRA PDU giving complementary information in the PSS1 DISCONNECT or PSS1 Facility message sent by the originating SwMI or a participating SwMI shall be as defined in table 44.

The ISI-DISCONNECT PDU is sent to the CSwMI by P/OSwMIs. It may be sent when a calling party disconnects, or when a SwMI wishes to withdraw from the call. The only mandatory use of the PDU is during call setup when an OSwMI changes into a PSwMI, because its entire set of calling parties no longer wish to be in the call.

If the ISI-DISCONNECT PDU is sent in a PSS1 Facility PDU the CSwMI determines if the sending SwMI shall be removed from call, in which case it will send ISI-RELEASE PDU to the SwMI. The CSwMI could, alternatively, decide to terminate the call at all SwMIs. If it chooses this course of action, an ISI-RELEASE PDU is sent to all SwMIs. It could take no action, in which case no PDUs are sent. If the ISI-DISCONNECT PDU is sent in a PSS1 Disconnect message then the sending SwMI is out of the call and is sent an ISI-RELEASE PDU by the CSwMI. The CSwMI must determine if the remainder of the call can continue or not. If it continues no, PDUs are sent, if it is to be terminated ISI-RELEASE PDU is sent to all remaining SwMIs in the call.

**Table 44: Contents of TETRA PDU sent in the PSS1 DISCONNECT or PSS1 FACILITY message sent by the originating SwMI or a participating SwMI**

Information element	Length	Type	Owner	C/O/M	Remark
PDU Type	6	1	CCAp	M	ISI-DISCONNECT
Call owner request	1	1	CCAp	M	See note
Disconnect cause	6	1	CCAp	M	
Notification indicator	6	2	SS	O	
Proprietary		3	-	O	
NOTE:	This field is to be interpreted as follows: If it is set to "call owner has not requested disconnect" it means that there are still other calling parties at the sending SwMI. If the field's value is set to "Call owner requested disconnect" it means that there are no other calling parties at the sending SwMI.				

#### 6.3.1.1.5 TETRA PDU giving complementary information in the PSS1 DISCONNECT, PSS1 FACILITY or PSS1 RELEASE message

It should be noted that if supplementary service information is to be exchanged during call disconnection, the following PDU shall be sent in a PSS1 FACILITY information element. Once the supplementary service information sequence is complete, the PSS1 RELEASE message shall be sent in response to the PSS1 DISCONNECT message.

##### 6.3.1.1.5.1 TETRA PDU sent by the controlling SwMI - used for releasing the call

The contents and the encoding of the TETRA PDU giving complementary information in the PSS1 DISCONNECT, PSS1 RELEASE or PSS1 FACILITY message sent by the controlling SwMI shall be as defined in table 45.

The ISI-RELEASE PDU is sent from the CSwMI. There are two different uses of the ISI-RELEASE PDU.

The first use is when the "disconnect type" field is set to "delay group call setup" and is always sent in an underlying PSS1 Facility message. This is used when the CSwMI has decided to delay the set up of the call. The CSwMI may choose to delay the set up of the call when it does not have the conditions it needs to connect the call. The ISI-RELEASE PDU (delay group call setup) can only be sent to a SwMI that has returned an ISI-SETUP-ACKNOWLEDGE PDU to the CSwMI. A SwMI that receives an ISI-RELEASE PDU (delay group call setup) can use the knowledge of the delay of the call as it chooses. For example, the SwMI may decide to release any resources it has already reserved so that the call could be connected, or it may choose to do nothing.

The second use of an ISI-RELEASE PDU is when the "disconnect type" is set to a value other than "delay group call setup". In this case, the ISI PDU is sent in an underlying PSS1 Disconnect or PSS1 Release message. Uses in this sense are as follows:

The ISI-RELEASE PDU is used as a response to an ISI-DISCONNECT PDU, however it is not always the case that every ISI-DISCONNECT PDU is responded to with an ISI-RELEASE PDU. See the definition of the ISI-DISCONNECT PDU for further details.

The ISI-RELEASE PDU can be sent, unilaterally, by the CSwMI to any SwMI that it wants to remove from the call.

**NOTE:** In the case where the ISI-RELEASE PDU is sent in an underlying PSS1 Release message, there is a high probability that the ISI-RELEASE PDU will not be received at its intended destination. This is because the PSS1 Release message does not have end-to-end significance. This only happens when the CSwMI receives an ISI-DISCONNECT PDU in a PSS1 Disconnect message. Since the leg of the group call is clearing, and the ISI-RELEASE PDU carries no information of value (the "disconnect cause" came in the original ISI-DISCONNECT PDU), the loss of the ISI-RELEASE PDU is considered acceptable. The sending CSwMI may choose not to send any ISI PDU, and only send the PSS1 Release message, when an ISI-RELEASE PDU would be sent in a PSS1 Release message.

**Table 45: Contents of TETRA PDU sent in the PSS1 DISCONNECT, PSS1 FACILITY or PSS1 RELEASE message sent by the controlling SwMI**

Information element	Length	Type	Owner	C/O/M	Remark
PDU Type	6	1	CCAp	M	ISI-RELEASE
Disconnect type	2	1	CCAp	M	
Disconnect cause	6		CCAp	C	See note
Notification indicator	6	2	SS	O	
Proprietary		3	-	O	
NOTE: This information element shall be present only when the value of the information element "Disconnect type" is other than "delay group call set-up".					

#### 6.3.1.1.6 TETRA PDU giving complementary information in the PSS1 DISCONNECT or PSS1 RELEASE COMPLETE message

A PSS1 RELEASE COMPLETE message shall be sent to the controlling SwMI when no PSS1 message previously has been sent in response to the PSS1 SETUP message. Otherwise a PSS1 DISCONNECT message is sent.

##### 6.3.1.1.6.1 TETRA PDU sent by the group home SwMI or the linking controlling SwMI - used to re-route the call

The contents and the encoding of the TETRA PDU giving complementary information in the PSS1 DISCONNECT or PSS1 RELEASE COMPLETE message sent by the group home SwMI or the linking controlling SwMI shall be as defined in table 46.

**Table 46: Contents of TETRA PDU sent in the PSS1 DISCONNECT or PSS1 RELEASE COMPLETE message sent by the group home SwMI or the linking controlling SwMI**

Information element	Length	Type	Owner	C/O/M	Remark
PDU Type	6	1	CCAp	M	ISI-REROUTE
Forwarded-to group address SSI	24	1	CCAp	M	
Group/Linking home SwMI MNI	24	1	ANF	M	
Notification indicator	6	2	SS	O	
Proprietary		3	-	O	

##### 6.3.1.1.6.2 TETRA PDU sent by the group home SwMI or the linking controlling SwMI - used to reject a forward set-up

When a forward group call request is rejected by either the group home SwMI or the linking controlling SwMI, the PSS1 DISCONNECT or PSS1 RELEASE COMPLETE message shall include the following TETRA PDU. The contents and the encoding of this TETRA PDU shall be as defined in table 47.

**Table 47: Contents of TETRA PDU sent in the PSS1 DISCONNECT or PSS1 RELEASE COMPLETE message sent by the group home SwMI or the linking controlling SwMI**

Information element	Length	Type	Owner	C/O/M	Remark
PDU Type	6	1	CCAp	M	ISI-REJECT
Reject cause	6	1	CCAp	M	
Notification indicator	6	2	SS	O	
Proprietary		3	-	O	

The group home SwMI or the linking controlling SwMI shall, according to clause 10.2.2 of ISO/IEC 11572 [11], send a PSS1 RELEASE COMPLETE message, instead of a PSS1 DISCONNECT message, when no prior PSS1 message has been sent by the SwMI.

### 6.3.1.1.6.3 TETRA PDU sent by a participating SwMI - used as a call set-up reject

When an ISI-SETUP INITIATE PDU cannot be accepted by a participating SwMI, the PSS1 DISCONNECT or PSS1 RELEASE COMPLETE message shall be returned to the controlling SwMI with the following TETRA PDU. The contents and the encoding of this TETRA PDU shall be as defined in table 48.

**Table 48: Contents of TETRA PDU sent in the PSS1 DISCONNECT or PSS1 RELEASE COMPLETE message sent by a participating SwMI**

Information element	Length	Type	Owner	C/O/M	Remark
PDU Type	6	1	CCAp	M	ISI-REJECT
Reject cause	6	1	CCAp	M	
Notification indicator	6	2	SS	O	
Proprietary		3	-	O	

### 6.3.1.2 PISN connection oriented, call independent connections

#### 6.3.1.2.1 TETRA PDU sent by the participating SwMI of the migrated user - used to initiate call restoration

When a member of a group call migrates during the call, a call restoration request will be sent by the migrated user to the new SwMI. The new SwMI shall inform the controlling SwMI of the call restoration request.

A new ANF-ISIGC connection shall be established if no call unrelated connection exists to the controlling SwMI. The participating SwMI shall send a PSS1 SETUP message containing the TETRA PDU below when a new connection is established and a PSS1 FACILITY message containing the TETRA PDU below when a connection already exists. The contents and the encoding of which shall be as defined in table 49.

**Table 49: Contents of TETRA PDU in call unrelated PSS1 SETUP or FACILITY message sent in the case of call restoration during migration**

Information element	Length	Type	Owner	C/O/M	Remark
PDU type	6	1	CCAp	M	ISI-CALL RESTORATION
New SwMI MNI	24	1	ANF	M	See note 1
Previous SwMI MNI	24	1	ANF	M	
Previous SwMI call identifier	14	1	ANF	M	
Restoring party address SSI	24	1	CCAp	M	
Restoring party extension	24	1	CCAp	M	
SS-CLIR invoked for restoring party	1	1	SS	M	
Request to transmit/send data	1	1	CCAp	M	See note 2
Group SSI	24	1	CCAp	M	
Group extension	24	1	CCAp	M	
Notification indicator	6	2	SS	O	
DM-MS address		3	CCAp	O	
Proprietary		3	-	O	

NOTE 1: New participating SwMI for a group call.  
NOTE 2: This information element is defined in the standard, EN 300 392-2 [3].

### 6.3.1.2.2 TETRA PDU sent by the controlling SwMI - used to confirm call restoration

To indicate that the new SwMI can perform call restoration towards the migrated user, the controlling SwMI shall send a PSS1 CONNECT or PSS1 FACILITY message containing the TETRA PDU as defined in table 50.

**Table 50: Contents of TETRA PDU in call unrelated PSS1 CONNECT or FACILITY message**

Information element	Length	Type	Owner	C/O/M	Remark
PDU type	6	1	CCAp	M	ISI-CALL RESTORATION ACK
Previous SwMI call identifier	14	1	CCAp	M	See note 1
Restoring party address SSI	24	1	CCAp	M	
Restoring party extension	24	1	CCAp	M	
Temporary group member indication	1	1	CCAp	M	See note 3
Transmission grant	2	1	CCAp	M	
Transmission request permission	1	1	CCAp	M	
Temporary group basic migration profile	variable		CCAp	C	See note 4
SS migration profile	variable		SS	C	See note 5
Notification indicator	6	2	SS	O	
DM-MS address		3	CCAp	O	
Proprietary		3	-	O	

NOTE 1: Previous SwMI call identifier is the call ID received from the MS in the U-RESTORE.  
NOTE 2: Void.  
NOTE 3: This information element indicates if the restoring user is a temporary group member.  
NOTE 4: Depending on the value of 'temporary group member indication'. The profile is a group profile that is only valid for the duration of the group call. The profile shall reflect the restored call.  
NOTE 5: Depending on the value of 'temporary group member indication'. The contents of S-ISI-PROFILE shall be defined, if applicable, for the supplementary service in each supplementary service sub-part of EN/ETS 300 392-12 [9] when valid at this point in the call.

### 6.3.1.2.3 TETRA PDU sent by the controlling SwMI - used to reject call restoration

To indicate that the new SwMI shall reject the call restoration from the migrated user, the controlling SwMI shall send a PSS1 CONNECT or PSS1 FACILITY message containing the TETRA PDU as defined in table 51.

**Table 51: Contents of TETRA PDU in call unrelated PSS1 CONNECT or FACILITY message**

Information element	Length	Type	Owner	C/O/M	Remark
PDU type	6	1	CCAp	M	ISI-CALL RESTORATION NACK
Previous SwMI call identifier	14	1	CCAp	M	See note
Fail Cause	3	1	CCAp	M	
Restoring party address SSI	24	1	CCAp	M	
Restoring party extension	24	1	CCAp	M	
Notification indicator	6	2	SS	O	
Proprietary		3	-	O	

NOTE: Previous SwMI call identifier is the call ID received from the MS in the U-RESTORE.

## 6.3.2 TETRA PDU information element coding

The majority of information elements included in the TETRA PDU definitions in clause 6.3.1 are equal to those defined for the air interface PDUs - see clause 14.8 of EN 300 392-2 [3] for these definitions. However, a few ISI specific information elements have been included.

NOTE: A given PDU information element already defined for the air interface may or may not take all its possible values when used in ISI TETRA PDUs.

### 6.3.2.1 Additional information to existing information element at the ISI

#### 6.3.2.1.1 Call status

An extra value is defined above that defined in clause 14.8.13 EN 300 392-2 [3] for the exclusive use of ANF-ISIGC.

An ISI-INFO is sent by the CSwMI to any SwMI that is still delaying when the call connects. The CSwMI indicates "call\_connected" to these SwMIs.

**Table 51a: Call status, information element**

Information element	Length	Value	Remark
Call status	3	000 <sub>2</sub>	Call is progressing
		001 <sub>2</sub>	Call is queued
		010 <sub>2</sub>	Requested subscriber is paged
		011 <sub>2</sub>	Call Continue
		100 <sub>2</sub>	Hang time expired
		101 <sub>2</sub>	Call connected, note
		110 <sub>2</sub>	Reserved
		111 <sub>2</sub>	Reserved
NOTE: Only used for ANF-ISIGC by a CSwMI that has connected the call, and needs to inform delaying SwMIs of this fact.			

#### 6.3.2.1.1a Call time-out, set-up phase

As opposed to the definition for the air interface protocol (clause 14.8.17 of EN 300 392-2 [3]) this information element is not be used to set the call time-out timer, for the set-up phase at the air interface of the calling user (T302). It is simply used to inform the originating SwMI of the call set-up time used by the controlling SwMI during the set-up phase.

NOTE 1: It is up to the originating SwMI to decide if the relevant timer in the MS should be equivalent to or greater than the received value.

NOTE 2: Refer to an alternative the Setup response time-out information element defined in clause 6.3.2.2.26a.

The coding of this information element, is the same as defined in clause 14.8.17 of EN 300 392-2 [3]. However, no predefined value is used (i.e. the value 000<sub>2</sub> is reserved). The coding shall be as defined in table 52.

**Table 52: Call time-out, set-up phase information element contents**

Information element	Length	Value	Remark
Call time-out, set-up phase	3	000 <sub>2</sub>	Reserved
		001 <sub>2</sub>	1 s
		010 <sub>2</sub>	2 s
		011 <sub>2</sub>	5 s
		100 <sub>2</sub>	10 s
		101 <sub>2</sub>	20 s
		110 <sub>2</sub>	30 s
		111 <sub>2</sub>	60 s

#### 6.3.2.1.2 Call time-out

This information element is also only used to inform the originating and participating SwMI(s) of the call length time used by the controlling SwMI during the maintenance phase of the call.

NOTE: It is up to the originating and participating SwMI(s) to decide if the relevant timer in the MS should be equivalent to or greater than the received value.

The coding of this information element, shall be as defined in clause 14.8.16 of EN 300 392-2 [3].

### 6.3.2.1.3 Disconnect cause information element

The purpose of the disconnection cause information element is to inform either the participating SwMI(s) or the controlling SwMI of the reason for the release/disconnection. This information element shall be coded as defined in table 53.

**Table 53: Disconnect cause information element contents**

Information element	Length	Value	Remark
Disconnect cause	6	0XXXXX <sub>2</sub>	<b>Air Interface disconnect causes</b>
		000000 <sub>2</sub>	Refer to EN 300 392-2 [3], see note
		etc.	etc.
		011111 <sub>2</sub>	Refer to EN 300 392-2 [3], see note
		1XXXXX <sub>2</sub>	<b>ISI specific disconnection causes</b>
		100000 <sub>2</sub>	Reserved for ANF-ISIIC, see EN 300 392-3-2 [5], clause 6.3.2.1.4
		etc.	etc.
		101111 <sub>2</sub>	Reserved for ANF-ISIIC, see EN 300 392-3-2 [5] , clause 6.3.2.1.4
		110000 <sub>2</sub>	Call not established to critical user
		110001 <sub>2</sub>	Call could not be restored to call owner
		110010 <sub>2</sub>	No resources for group call
		110011 <sub>2</sub>	No participants
		110100 <sub>2</sub>	Unknown group identity
		110101 <sub>2</sub>	Expiry of timer
		110110 <sub>2</sub>	Reserved for other ANF-ISIGC disconnection causes
		etc.	etc.
111110 <sub>2</sub>	Reserved for other ANF-ISIGC disconnection causes		
111111 <sub>2</sub>	Reserved		
NOTE: All values 0XXXXX <sub>2</sub> shall be as defined in clause 14.8.18 of EN 300 392-2 [3] for the same values (XXXXX <sub>2</sub> ).			

NOTE: 6 bits are used for encoding the disconnect cause information element. This is one more bit than what is used at the air interface for the disconnect cause information element. The binary values 000000<sub>2</sub> to 011111<sub>2</sub> have remained unchanged while the values from 100000<sub>2</sub> to 111110<sub>2</sub> will be used as ISI specific definitions.

### 6.3.2.1.4 Temporary group basic migration profile

The temporary group basic migration profile is defined in EN 300 392-3-5 [6]. The profile shall reflect the actual call being connected. The profile status shall indicate that this is a temporary profile only to be used for the duration of the call. The profile shall only be valid for the temporary group member.

### 6.3.2.1.5 PDU type

The purpose of the PDU type information element is to identify the type of TETRA PDU sent over the ISI in a PSS1 message. This information element shall be coded as defined in table 54.

NOTE 1: A PDU type value exist for each TETRA PDU, even though only one TETRA PDU will be sent in the given PSS1 (basic call) message.

**Table 54: PDU type information element contents**

Information element	Length	Value	Remark
PDU Type	6	000000 <sub>2</sub>	Reserved for ANF-ISIIC
		etc.	etc.
		100000 <sub>2</sub>	Reserved for ANF-ISIIC
		100001 <sub>2</sub>	ISI-ORIGINATING SETUP (see table 24)
		100010 <sub>2</sub>	ISI-SETUP INITIATE (see table 25)
		100011 <sub>2</sub>	ISI-SETUP ACKNOWLEDGE (see table 27)
		100100 <sub>2</sub>	ISI-CONNECT (see table 29)
		100101 <sub>2</sub>	ISI-INFO (see table 26, 32 and 33)
		100110 <sub>2</sub>	ISI-REROUTE (see table 46)
		100111 <sub>2</sub>	ISI-DELAY (see table 28)
		101000 <sub>2</sub>	ISI-POLL USER (see table 30)
		101001 <sub>2</sub>	ISI-POLL RESPONSE (see table 31)
		101010 <sub>2</sub>	ISI-REJECT (see table 43, 47 and 48)
		101011 <sub>2</sub>	ISI-DISCONNECT (see table 44)
		101100 <sub>2</sub>	SI-RELEASE (see table 45)
		101101 <sub>2</sub>	ISI-CALL RESTORATION (see table 49)
		101110 <sub>2</sub>	ISI-CALL RESTORATION ACK (see table 50)
		101111 <sub>2</sub>	ISI-CALL RESTORATION NACK (see table 51)
		110000 <sub>2</sub>	ISI-TX DEMAND (see table 34)
		110001 <sub>2</sub>	<b>Reserved</b>
		110010 <sub>2</sub>	ISI-TX GRANTED (see table 39)
		110011 <sub>2</sub>	ISI-TX INTERRUPT (see table 40)
		110100 <sub>2</sub>	ISI-TX CEASED (see tables 38)
		110101 <sub>2</sub>	ISI-RESOURCE (see table 36)
		110110 <sub>2</sub>	ISI-RESOURCE RESPONSE (see table 37)
		110111 <sub>2</sub>	ISI-TX WAIT (see table 42)
		111000 <sub>2</sub>	ISI-TX CONTINUE (see table 41)
111001 <sub>2</sub>	Reserved		
etc.	etc.		
111111 <sub>2</sub>	Reserved		

NOTE 2: 6 bits are used for encoding the PDU type information element. This is one more bit than what is used at the air interface for the PDU type information element. The PDU types having the binary values 000000<sub>2</sub> to 011111<sub>2</sub> correspond to the values of the downlink PDUs defined in clause 14.8.28 of EN 300 392-2 [3] while the binary values from 100000<sub>2</sub> to 111111<sub>2</sub> are used as ISI specific definitions.

### 6.3.2.1.6 SS-migration profile

The SS-migration profile is defined in EN 300 392-3-5 [6]. The profile shall reflect the actual call being connected. The profile status shall indicate that this is a temporary profile only to be used for the duration of the call. The profile shall only be valid for the temporary group member.



## 6.3.2.2 New information elements used at the ISI

### 6.3.2.2.1 Call amalgamation

Call amalgamation information element shall be encoded as defined in table 54a.

**Table 54a: Call amalgamation, information element**

Information element	Length	Value	Remark
Call amalgamation	1	0	Call has not been amalgamated
		1	Call has been amalgamated

### 6.3.2.2.1a Call resource time-out

This information element is used to inform the controlling SwMI of the call resource time-out timer. This timer shall indicate the period of time the participating/originating SwMI shall hold resources reserved within the SwMI.

The coding of this information element, shall be as defined in table 55.

**Table 55: Call resource time-out information element contents**

Information element	Length	Value	Remark
Call connect time-out	3	000 <sub>2</sub>	Reserved
		001 <sub>2</sub>	5 s
		010 <sub>2</sub>	10 s
		011 <sub>2</sub>	15 s
		100 <sub>2</sub>	20 s
		101 <sub>2</sub>	25 s
		110 <sub>2</sub>	30 s
		111 <sub>2</sub>	Reserved

### 6.3.2.2.2 Call diverted to dispatcher

This information element shall be coded as defined in table 56.

**Table 56: Call diverted to dispatcher information element contents**

Information element	Length	Value	Remark
Call diverted to dispatcher	1	0	Call not diverted to a dispatcher
		1	Call diverted to a dispatcher

### 6.3.2.2.3 Call owner request

This information element shall be coded as defined in table 57.

**Table 57: Call owner request information element contents**

Information element	Length	Value	Remark
Call owner request	1	0	Call owner has not requested disconnect
		1	Call owner requested disconnect

#### 6.3.2.2.4 Calling group identifier

This information element shall be coded as defined in table 57a.

**Table 57a: Calling group identifier information element contents**

Information element	Length	Value	Remark
Calling group identifier	1	0	Calling group GTSI not present
		1	Calling group GTSI present

#### 6.3.2.2.4a Calling party information present

This information element shall be coded as defined in table 57b.

**Table 57b: Calling party information present information element contents**

Information element	Length	Value	Remark
Calling party information present	1	0	Calling party information is not present
		1	Calling party information is present

#### 6.3.2.2.5 Connected party SSI and extension

The coding of these information elements shall be the same as defined in clauses 14.8.11 and 14.8.10 of EN 300 392-2 [3]. The information element shall always identify a group of subscriber (TETRA group identity).

#### 6.3.2.2.6 Controlling/originating/participating SwMI MNI

This information element shall be coded as defined in table 58.

**Table 58: Controlling/group home/linking home/originating/participating SwMI MNI information element contents**

Information element	Length	Value	Remark
Country Code	10		See EN 300 392-1 [2], clause 7
Network Code	14		See EN 300 392-1 [2], clause 7

#### 6.3.2.2.7 Critical connected party/requesting party/restoring party/transmitting party SSI and extension

The coding of these information elements shall be the same as defined in clauses 14.8.11 and 14.8.10 of EN 300 392-2 [3]. The information element shall always identify an individual subscriber.

#### 6.3.2.2.8 Critical user list

This information element shall be coded as defined in table 59.

**Table 59: Critical user list element contents**

Information element	Length	Type	Owner	C/O/M	Remark
Critical connected party SSI	24	1	CCAp	M	See clause 6.3.2.2.7 for definition
Critical connected party extension	24	1	CCAp	M	See clause 6.3.2.2.7 for definition

## 6.3.2.2.9 Disconnect type

This information element shall be coded as defined in table 60.

**Table 60: Disconnect type information element contents**

Information element	Length	Value	Remark
Disconnect type	2	00 <sub>2</sub>	Full disconnection of call
		01 <sub>2</sub>	Partial disconnection of call
		10 <sub>2</sub>	Delay group call set-up
		11 <sub>2</sub>	Reserved

## 6.3.2.2.10 Dispatcher acceptance

This information element shall be coded as defined in table 61.

**Table 61: Dispatcher acceptance information element contents**

Information element	Length	Value	Remark
Dispatcher acceptance	1	0	SS-CAD has not been invoked
		1	The dispatcher has accepted the call

## 6.3.2.2.11 External group member identity

This information element shall be coded as defined in table 62.

**Table 62: External group member identity information element contents**

Information element	Length	Type	Owner	C/O/M	Remark
External subscriber number length	5	1	CCAp	M	See table 64 for definition - see note 1
External subscriber number digits	variable		CCAp	C	See table 63 for definition - see note 2
External subscriber number parameter	12		CCAp	C	See table 65 for definition - see note 3
NOTE 1: Shall be equal to 00000 <sub>2</sub> in the case of inter-TETRA calls, and to N, N being the number of digits of the external calling party number in the case of an external incoming call from PSTN/ISDN/PISN if the calling party identification is delivered by that external network.					
NOTE 2: The number of digits included in this information element shall be equal to N, the value of the external subscriber number length (see note 1), i.e. this information element shall be conditional on the value of N.					
NOTE 3: This information element shall be present only when the external subscriber number length value N is not 00000 <sub>2</sub> .					

## 6.3.2.2.12 External subscriber number digits

The information element external subscriber number digits is a binary string with a length equal to 4 times N, where N is equal to the value of the information element 'external subscriber number length'. The 'external subscriber number length' information element shall always precede the "external subscriber number digits" in TETRA PDUs. The first 4 bits of the binary string shall be the coded value of the first digit (or symbol) of the external subscriber number, the next four bits shall be the coded value of the second digit (or symbol), and so on forth until the Nth digit has been coded.

Each digit of the external subscriber number shall be coded as defined in EN 300 392-2 [3], clause 14.8.20. According to that each digit is coded into its binary value using 4 bits, the "\*" sign shall be coded as "1010<sub>2</sub>", the "#" as "1011<sub>2</sub>" and the "+" as "1100<sub>2</sub>", and the remaining binary values "1101<sub>2</sub>", "1110<sub>2</sub>" and "1111<sub>2</sub>" are reserved. The order of these digits shall be that in which they would be dialled: the first one would then be entered first, and so on.

Table 63 illustrates this definition.

**Table 63: External subscriber number digits information element contents**

Information element	Length	Value
External subscriber number digits	4 x N	(xxx <sub>2</sub> ) (xxx <sub>2</sub> ) (xxx <sub>2</sub> ) (xxx <sub>2</sub> ) etc. 1st digit 2nd digit 3rd digit 4th digit

### 6.3.2.2.13 External subscriber number length

This information element shall be coded as defined in table 64.

**Table 64: External subscriber number length information element contents**

Information element	Length	Value	Remark
External subscriber number length	5	0000 <sub>2</sub>	See note 1
		XXXXX <sub>2</sub>	See note 2
NOTE 1: The presence of the information element "external subscriber number digits" shall be conditional on the value of this information element being different from 0.			
NOTE 2: The number of digits in the information element "external subscriber number digits" shall be equal to N, the decimal number corresponding to the binary value XXXXX <sub>2</sub> .			

NOTE: The external subscriber number length is needed according to the PDU encoding rules defined in clause 14.7 of EN 300 392-2 [3], for encoding the number digits (the length of which is variable) as "a type 1 element".

### 6.3.2.2.14 External subscriber number parameter

This information element external subscriber number parameter in the case of interworking shall be encoded as defined in table 65.

**Table 65: External subscriber number parameter information element contents**

Information element	Length	Type	Owner	C/O/M	Remark
Numbering plan identifier	4	1	CCAp	M	See table 71 for definition
Type of Number	3	1	ANF	M	See table 85 for definition
Screening indicator	2	2	SS	O	See table 77 for definition

### 6.3.2.2.15 Fail Cause

The purpose of the fail cause information element is to inform the new visiting SwMI of the reason for call restoration failure. This information element shall be coded as defined in table 66.

**Table 66: Fail cause information element contents**

Information element	Length	Value	Remark
Fail cause	3	000 <sub>2</sub>	Cause not defined or unknown
		001 <sub>2</sub>	Invalid call identifier
		010 <sub>2</sub>	Restoring party not allowed to participate in call
		011 <sub>2</sub>	Group not attached
		100 <sub>2</sub>	Outside of selected area
		101 <sub>2</sub>	Reserved
		110 <sub>2</sub>	Reserved
		111 <sub>2</sub>	Reserved

The fail causes above map to the air interface as follows.

**Table 67: Fail cause mapping**

Fail Cause	Disconnect Cause
Cause not defined or unknown	Cause not defined or unknown
Invalid call identifier	Invalid call identifier
Restoring party not allowed to participate in call	SwMI requested disconnect
Group not attached	SwMI requested disconnect
Outside of selected area	SwMI requested disconnect

### 6.3.2.2.16 Group attachment indicator

This information element shall be coded as defined in table 68.

**Table 68: Group attachment indicator information element contents**

Information element	Length	Value	Remark
Group attachment indicator	1	0	The calling user has attached to the called group
		1	The calling user has not attached to the called group

### 6.3.2.2.16a Group call SwMI type

This information element shall be coded as defined in table 68a.

**Table 68a: Group call SwMI type, information element contents**

Information element	Length	Value	Remark
Group call SwMI type	1	0	From Originating SwMI
		1	From Participating SwMI
NOTE 1: An Originating SwMI is a SwMI that has sent in an ISI-Originating-Setup to the CSwMI, and has not also sent in an ISI-Disconnect with "call owner request" set to "call owner requested disconnect". An OSwMI becomes a PSwMI once an ISI-Connect is received or when it knows that the call has been connected, even if it has not yet been connected into the call.			
NOTE 2: A Participating SwMI is a SwMI that has not sent in an ISI-Originating-Setup, or one that has send in ISI-Originating-Setup but has followed it with an ISI-Disconnect with the "call owner request" set to "call owner requested disconnect".			
NOTE 3: All SwMIs that receive an ISI-Connect are from then onwards PSwMIs.			
NOTE 4: All SwMIs that know that the call has connected, even if they have not yet been connected into the call, are PSwMIs.			

### 6.3.2.2.17 Group information

This information element group information in the case of interworking shall be encoded as defined in table 69.

**Table 69: Group information element contents**

Information element	Length	Value	Remark
Group information	2	0	Reserved
		1	Call not established to critical user
		2	Reserved
		3	Reserved

## 6.3.2.2.17a ISI-INFO type

The ISI-INFO type information element is used to assist in the decoding of ISI-Info PDUs. The present document contains three such ISI-Info PDUs, each of which is defined differently. This information element allows the decoder to determine what type of ISI-Info PDU is being decoded. The ISI-INFO type information element shall be coded as defined in table 69a.

Table 69a: ISI-INFO type, information element

Information element	Length	Value	Remark
ISI-INFO type	3	000 <sub>2</sub>	From CSwMI, to OSwMI only
		001 <sub>2</sub>	From CSwMI, updated group information
		010 <sub>2</sub>	From PSwMI
		011 <sub>2</sub>	Reserved
		100 <sub>2</sub>	Reserved
		101 <sub>2</sub>	Reserved
		110 <sub>2</sub>	Reserved
		111 <sub>2</sub>	Reserved

## 6.3.2.2.17b Linking group identifier

This information element shall be coded as defined in table 69b.

Table 69b: Linking group identifier information element contents

Information element	Length	Value	Remark
Linking group identifier	1	0	Linking group GTSI not present
		1	Linking group GTSI present

## 6.3.2.2.18 New calling party

This information element shall be coded as defined in table 70.

Table 70: New calling party information element contents

Information element	Length	Type	Owner	C/O/M	Remark
Calling party SSI	24	1	CCAp	M	See note 1
Calling party extension	24	1	CCAp	M	See note 1
External subscriber number length	5	1	CCAp	M	See table 64 for definition - see note 2
External subscriber number digits	variable		CCAp	C	See table 63 for definition - see note 3
External subscriber number parameters	12		CCAp	C	See table 65 for definition - see note 4
NOTE 1: In the case of an external incoming call, the calling party SSI and the calling party extension shall be those of the incoming gateway SwMI.					
NOTE 2: Shall be equal to 00000 <sub>2</sub> in the case of inter-TETRA calls, and to N, N being the number of digits of the external calling party number in the case of an external incoming call from PSTN/ISDN/PISN if the calling party identification is delivered by that external network.					
NOTE 3: The number of digits included in this information element shall be equal to N, the value of the external subscriber number length (see note 2), i.e. this information element shall be conditional on the value of N.					
NOTE 4: This information element shall be present only when the external subscriber number length value N is not 00000 <sub>2</sub> .					

## 6.3.2.2.19 Numbering plan identifier

This information element shall be coded as defined in table 71.

**Table 71: Numbering plan identifier information element contents**

Information element	Length	Value	Remark
Numbering plan identification	4	0000 <sub>2</sub>	Unknown
		0001 <sub>2</sub>	PSTN/ISDN/GSM (see note 1)
		0010 <sub>2</sub>	Reserved
		0011 <sub>2</sub>	Data Numbering Plan (see note 2)
		0100 <sub>2</sub>	Reserved (Telex)
		0101 <sub>2</sub>	Reserved
		etc.	etc.
		0111 <sub>2</sub>	Reserved
		1000 <sub>2</sub>	National standard numbering plan
		1001 <sub>2</sub>	Private numbering plan
		1010 <sub>2</sub>	Reserved for extension
		etc.	etc.
		1111 <sub>2</sub>	Reserved for extension
NOTE 1: See ITU-T Recommendation E.164 [i.8].			
NOTE 2: See ITU-T Recommendation X.121 [i.9].			

## 6.3.2.2.20 Poll request type

This information element shall be coded as defined in table 72.

**Table 72: Poll request type information element contents**

Information element	Length	Value	Remark
Poll request type	1	0	Poll response number wanted
		1	Poll response percentage wanted

## 6.3.2.2.21 Poll result identifier

This information element shall be coded as defined in table 73.

**Table 73: Poll result identifier information element contents**

Information element	Length	Value	Remark
Poll result identifier	1	0	Poll response number given
		1	Poll response percentage given

## 6.3.2.2.22 Reject cause information element

The purpose of the reject cause information element is to inform either the originating SwMI or the controlling SwMI of the reason for rejection. This information element shall be coded as defined in table 74.

Table 74: Reject cause information element contents

Information element	Length	Value	Remark		
Reject cause	6	0XXXXX <sub>2</sub>	<b>Air Interface disconnect causes</b>		
		000000 <sub>2</sub>	Refer to EN 300 392-2 [3], see note		
		etc.	etc.		
		011111 <sub>2</sub>		Refer to EN 300 392-2 [3], see note	
		1XXXXX <sub>2</sub>		<b>ISI specific reject causes</b>	
		100000 <sub>2</sub>		Reserved	
		etc.	etc.		
		101111 <sub>2</sub>		Reserved	
		110000 <sub>2</sub>		Reserved	
		110001 <sub>2</sub>		Reserved	
		110010 <sub>2</sub>		No resources for group call	
		110011 <sub>2</sub>		No participants	
		110100 <sub>2</sub>		Unknown group identity	
		110101 <sub>2</sub>		Reserved	
		110110 <sub>2</sub>		Reserved	
		110111 <sub>2</sub>		Reserved	
		111000 <sub>2</sub>		No resources for calling party or calling party disconnected	
		111001 <sub>2</sub>		Reserved	
		111010 <sub>2</sub>		Reserved	
		111011 <sub>2</sub>		Call rejected by the originating/participating SwMI	
		111100 <sub>2</sub>		Reserved	
		111101 <sub>2</sub>		Reserved	
		111110 <sub>2</sub>		Reserved	
		111111 <sub>2</sub>		Reserved (extension)	
		NOTE: All values 0XXXXX <sub>2</sub> shall be as defined in clause 14.8.18 of EN 300 392-2 [3] for the same values (XXXXX <sub>2</sub> ).			



## 6.3.2.2.23 Resource allocation

This information element shall be coded as defined in table 75.

**Table 75: Resource allocation information element contents**

Information element	Length	Value	Remark
Resource allocation	1	0	Permanently allocated resources
		1	Temporary allocated resources

## 6.3.2.2.24 Resource indicator

This information element shall be coded as defined in table 76.

**Table 76: Resource indicator information element contents**

Information element	Length	Value	Remark
Resource indicator	2	0	Resources are reserved
		1	Resources could not be reserved
		2	Resources could not be reserved, delay requested
		3	Reserved

## 6.3.2.2.25 Screening indicator

This information element shall be coded as defined in table 77.

**Table 77: Screening indicator information element contents**

Information element	Length	Value	Remarks
Screening indicator	2	00 <sub>2</sub>	User provided, not screened
		01 <sub>2</sub>	User provided, verified and passed
		10 <sub>2</sub>	User provided, verified and failed
		11 <sub>2</sub>	Network provided

## 6.3.2.2.26 Security level at air interface/Security level used in other network

This information element shall be coded as defined in table 78. The security classes shall be as defined clause 6.2 of EN 300 392-7 [7].

**Table 78: Security level information element contents**

Information element	Length	Value	Remark
Security level (..)	2	00 <sub>2</sub>	Class 1
		01 <sub>2</sub>	Class 2: SCK Mode
		10 <sub>2</sub>	Class 3: DCK Mode
		11 <sub>2</sub>	Reserved

## 6.3.2.2.26a Setup response time-out

The Setup response time-out information element shall be coded as defined in table 78a.

**Table 78a: Setup response time-out information element contents**

Information element	Length	Value	Remark
Setup response time-out	4	0000 <sub>2</sub>	Reserved
		0001 <sub>2</sub>	1 s
		0010 <sub>2</sub>	2 s
		0011 <sub>2</sub>	3 s
		0100 <sub>2</sub>	4 s
		0101 <sub>2</sub>	5 s
		0110 <sub>2</sub>	6 s
		0111 <sub>2</sub>	7 s
		1000 <sub>2</sub>	8 s
		1001 <sub>2</sub>	9 s
		1010 <sub>2</sub>	10 s
		1011 <sub>2</sub>	11 s
		1100 <sub>2</sub>	12 s
		1101 <sub>2</sub>	13 s
		1110 <sub>2</sub>	14 s
1111 <sub>2</sub>	15 s		

#### 6.3.2.2.27 Set-up type

This information element shall be coded as defined in table 79.

**Table 79: Set-up type information element contents**

Information element	Length	Value	Remark
Set-up type	2	0	Complete set-up of group call
		1	Partial set-up of group call

#### 6.3.2.2.28 Speech service chosen/requested/used

This information element shall be coded as defined in table 80.

**Table 80: Speech service chosen/requested/used information element contents**

Information element	Length	Value	Remark
Speech service chosen/ requested/used	3	000 <sub>2</sub>	CODEC defined in EN 300 395-2 [10]
		xx1 <sub>2</sub>	Reserved
		x10 <sub>2</sub>	Reserved
		100 <sub>2</sub>	Reserved

#### 6.3.2.2.29 Speech services supported

This information element is a bit-map field indicating which TETRA CODEC are supported. The meaning of each bit setting in this information element shall be as defined in table 81.

NOTE: This information element is not supported in the first edition of the present document.

**Table 81: Speech services supported information element contents**

Information element	Length	Value	Remark
Speech services supported	5	00000 <sub>2</sub>	Reserved
		00001 <sub>2</sub>	CODEC defined in EN 300 395-2 [10] supported
		00010 <sub>2</sub>	Reserved
		00100 <sub>2</sub>	Reserved
		01000 <sub>2</sub>	Reserved
		10000 <sub>2</sub>	Reserved

#### 6.3.2.2.30 SS-CLIR invoked for calling/transmitting/restoring/connected party

This information element shall be coded as defined in table 82.

**Table 82: SS-CLIR invoked for calling/transmitting/connected party information element contents**

Information element	Length	Value	Remark
SS-CLIR invoked for calling/transmitting/connected party	1	0	SS-CLIR not invoked for the party
		1	SS-CLIR invoked for the party

#### 6.3.2.2.31 Temporary group member indication

This information element shall be coded as defined in table 83.

**Table 83: Temporary group member indication information element contents**

Information element	Length	Value	Remark
Temporary group member indication	1	0	The calling, restoring or indicated user is a member of the group
		1	The calling, restoring or indicated user is a temporary member of the group

#### 6.3.2.2.32 Transmission Ceased

This information element shall be used to inform participating SwMIs of the reason for transmission cease.

**Table 84: Transmission ceased information element contents**

Information element	Length	Value	Remark
Transmission ceased	1	0	Cease current transmission
		1	Delay transmission request

### 6.3.2.2.33 Type of number

This information element shall be coded as defined in table 85.

**Table 85: Type of number information element contents**

Information element	Length	Value	Remarks
Type of number, (note)	3	000 <sub>2</sub>	Unknown/unknown
		001 <sub>2</sub>	International number/level 2 regional number
		010 <sub>2</sub>	National number/level 1 regional number
		011 <sub>2</sub>	Network specific number/PISN specific number
		100 <sub>2</sub>	Abbreviated number/level 0 regional number
		101 <sub>2</sub>	Reserved for extension
		..etc.	..etc.
		111 <sub>2</sub>	Reserved for extension
NOTE: This parameter is the meaning of the information element type of number as defined in ISO/IEC 11571 [14] when the numbering plan identification is the private numbering plan (i.e. binary value of the information sub-element equal to 1001 <sub>2</sub> ).			

### 6.3.3 PSS1 facility information element

The ROSE operation `tetraIsiMessage` referred to in clause 6.3 shall be coded in a PSS1 facility information elements in accordance to ISO/IEC 11582 [13]. The PSS1 facility information elements shall always include a Network Facility Extension (NFE).

The `destinationEntity` and `sourceEntity` data elements of the Network Facility Extension (NFE) shall contain the value `endPINX`. The `sourceEntity` and `destinationEntity` data elements of the argument of the ROSE operation `tetraIsiMessage` shall contain the value `ANF-ISIGC`.

Whenever the `ANF-ISIGC Invoke APDU` of the ROSE operation `tetraIsiMessage` is included in a PSS1 SETUP message, the Interpretation APDU shall be included with the value `"clearCallIfAnyInvokePduNotRecognized"`.

NOTE: According to clause 8.6 of EN 300 392-3-1 [4], if a called SwMI does not support inter-TETRA group calls, i.e. the SwMI does not have an `ANF-ISIGC` entity, the ROSE entity within this SwMI will upon reception of a PSS1 SETUP message:

- reject the ROSE Invoke APDU received; and
- clear the PSS1 call attempt due to the specific value of the Interpretation APDU received together with the ROSE Invoke APDU.

The Interpretation APDU shall not be included in any other `ANF-ISIGC Invoke APDU`s of the ROSE operation `tetraIsiMessage` other than the `ANF-ISIGC Invoke APDU`s sent in the PSS1 SETUP messages.

In accordance with EN 300 392-3-1 [4] clause 8.4, the receiving `ANF-ISIGC` entity in the destination SwMI shall trigger the sending of a `returnError APDU` when one or more of the error causes listed in this clause has occurred upon reception of an `Invoke APDU`.

When the ROSE entity in the source SwMI receives a `returnError APDU` or a `reject APDU`, it shall pass it on to the call control application in this SwMI. The decision taken by this call control application when the destination SwMI has not already cleared the call is an implementation matter (e.g. clearing the call or if the `Invoke APDU` was not essential, continue the call).

## 6.4 ANF-ISIGC state definitions

### 6.4.1 States at the originating SwMI

#### 6.4.1.1 IDLE

This is the initial state for the originating SwMI ANF-ISIGC entity. In this state FE1 shall:

- upon request from the CC application, fetch and analyse the calling users profile information;
- analyse the destination group identity (GTSI) and evaluate if an inter-TETRA connection needs to be established for the call set-up request;
- obtain routing information to the group home SwMI and route the call over an inter-TETRA connection.

From this state FE1 can go to state FORWARD CALL or WAIT CONNECT.

#### 6.4.1.2 FORWARD CALL

This is the state where the originating SwMI ANF-ISIGC entity waits for approval or rejection of the call set-up request. In this state FE1 should:

- receive information about call status and the call set-up time used by the controlling SwMI and forward this information to the originating SwMI CC application.

In this state FE1 shall:

- either receive information that the call set-up request has been rejected by the group home/controlling SwMI and forward this information to the originating SwMI CC application; or
- receive set-up information from the controlling SwMI and forward this information to the originating SwMI CC application;
- receive information from the originating SwMI CC application that either:
  - the call is ready for through connect and forward this information to the controlling SwMI; or
  - start timer T2 as indicated in clause 6.8;
  - the call has been rejected and forward this information to the controlling SwMI; or
  - the CC application wishes to delay the call set-up and forward this information to the controlling SwMI (this is not valid for a call set-up initiated by an external user);
- release reserved resources upon expiration of timer T2.

In this state FE1 may:

- receive a request to re-route the call set-up request from the group home SwMI to either the linking controlling SwMI or to a new group home SwMI (when SS-CFU has been invoked).

From this state FE1 can go to state WAIT CONNECT, DELAY ENTRY or IDLE.

#### 6.4.1.3 WAIT CONNECT

This is the state where call set-up has been initiated and the originating SwMI ANF-ISIGC entity is waiting for the call to be through connected. In this state FE1 shall:

- receive indication that the calling user is to be through connected and forward this information to the originating SwMI CC application; or
  - change status from an originating SwMI to a participating SwMI. The originating shall become idle;

- receive indication that the call is to be delayed and forward this information to the originating SwMI CC application;
  - receive indication that the originating SwMI CC application has accepted the delay and forward this information to the controlling SwMI.

In this state FE1 may:

- receive indication that this SwMI is being released from the call and forward this information to the originating SwMI CC application;
- receive information from the originating SwMI CC application that the call is to be disconnected in the originating SwMI and forward this information to the controlling SwMI.

From this state FE1 can go to state IDLE, DELAY GROUP CALL, CALL RELEASE or CALL DISCONNECT.

#### 6.4.1.4 DELAY ENTRY

This is the state used by the originating SwMI ANF-ISIGC entity when the CC application has informed the entity to delay the call set-up. In this state FE1 shall:

- receive information from the originating SwMI CC application that the SwMI is now ready for through connect and forward this information to the controlling SwMI; or
- receive indication that this SwMI is being released from the call and forward this information to the originating SwMI CC application; or
- receive information from the originating SwMI CC application that the call is to be disconnected in the originating SwMI and forward this information to the controlling SwMI.

From this state FE1 can go to state WAIT CONNECT, CALL DISCONNECT or CALL RELEASE.

#### 6.4.1.5 DELAY GROUP CALL

This is the state where the originating SwMI ANF-ISIGC entity has been delayed during call set-up. In this state FE1 shall:

- receive set-up information from the controlling SwMI and forward this information to the originating SwMI CC application. The call is no longer delayed; or
  - receive information from the originating SwMI CC application that the call is ready for through connect and forward this information to the controlling SwMI;
  - receive information from the originating SwMI CC application that the CC application wishes to delay the call set-up and forward this information to the controlling SwMI;
- receive indication that this SwMI is being released from the call and forward this information to the originating SwMI CC application; or
- receive information from the originating SwMI CC application that the call is to be disconnected in the originating SwMI and forward this information to the controlling SwMI.

From this state FE1 can go to state WAIT CONNECT, CALL RELEASE or CALL DISCONNECT.

#### 6.4.1.6 CALL DISCONNECT

The originating SwMI ANF-ISIGC entity is in this state when the CC application has made a request to be disconnected from the call. In this state FE1 shall:

- receive indication that this SwMI is being released from the call and forward this information to the originating SwMI CC application.

From this state FE1 can go to state CALL RELEASE.

### 6.4.1.7 CALL RELEASE

This is the state where the call is being released within the originating SwMI. This state may be used to collect call information, before the call is completely released. In this state FE1 shall:

- wait for confirmation from the originating SwMI CC application that release has been performed;
- complete the release the ANF-ISIGC (inter-TETRA) connection.

From this state FE1 can go to state IDLE.

## 6.4.2 States at the controlling SwMI

### 6.4.2.1 IDLE

This is the initial state for the controlling SwMI ANF-ISIGC entity. In this state FE2 shall:

- receive a request for group call set-up from an originating SwMI and forward this information to the controlling SwMI CC application;
- upon call set-up acceptance from the CC application:
  - fetch and analyse the called groups routing information and evaluate if the group is linked;
  - obtain routing information to the linking controlling SwMI if this is not to be the controlling SwMI for the call;
  - inform the originating SwMI that the call set-up request shall be re-routed, due to group linking or call forwarding unconditionally if this has occurred;
  - merge this call request to an already active call;
  - analyse the migration information for the group and evaluate if any inter-TETRA connection needs to be established for the call set-up;
  - obtain routing information to the participating SwMI(s) and route the call over an inter-TETRA connection to the originating SwMI and the participating SwMI(s).
- upon call set-up rejection from the CC application inform the originating SwMI that the call cannot be performed.

In this state FE2 should:

- send call status and call time out information for the set-up phase, to the originating SwMI.

From this state FE2 can go to state GROUP CALL INITIATE.

### 6.4.2.2 GROUP CALL INITIATE

This is the state used by the controlling SwMI ANF-ISIGC entity when waiting for call set-up responses from the originating and the participating SwMI(s). The decision to through connect the call, delay the call or release the call is made in this state. In this state FE2 shall:

- receive call set-up responses from participating SwMI(s) and the originating SwMI and forward this information to the controlling SwMI CC application;
- when indicated by the CC application, inform the participating SwMI(s) and the originating SwMI of one of the following:
  - the call is now to be through connected;
  - the call is to be delayed;
  - the call is to be released in the specified SwMI(s).

From this state FE2 can go to state DELAY GROUP CALL, ACTIVE or CALL RELEASE.

### 6.4.2.3 DELAY GROUP CALL

This is the state used when the controlling SwMI CC application has evaluated that the call set-up is to be delayed. In this state FE2 shall:

- receive delay acceptances from the participating SwMI(s) and the originating SwMI and forward this information to the controlling SwMI CC application;
- receive call set-up responses from delaying SwMI(s) and forward this information to the controlling SwMI CC application;
  - upon call set-up acceptance from the CC application, send a call set-up to all delayed SwMI(s);
- inform indicated SwMI(s) that the call is to be released when the CC application has indicated that the call shall be released in the specified SwMI(s).

In this state FE2 may:

- receive a request from a participating SwMI or the originating SwMI that it wishes to either be release from the call or it wishes to release the complete call;

From this state FE2 can go to state GROUP CALL INITIATE or CALL RELEASE.

### 6.4.2.4 ACTIVE

This is the state used by the controlling SwMI ANF-ISIGC entity when the call is through connected and active. In this state FE2 shall:

- when requested by the controlling SwMI CC application:
  - poll participating SwMI(s);
    - convey polling responses from participating SwMI(s) to the controlling SwMI CC application;
  - send call information to participating SwMI(s);
  - analyse migration information for the active group call and evaluate if a new inter-TETRA connection needs to be established for call restoration;
  - analyse if the migrated user was the last member of the group in the old participating SwMI;
    - release the call and the ANF-ISIGC connection from the old participating SwMI;
  - release the call and the ANF-ISIGC connection from the old participating SwMI;
  - inform SwMI(s) specified by that the CC application that the call is to be released;
- obtain routing information to the new participating SwMI (SwMIs with newly registered users or merged users) and route the call set-up information over a new inter-TETRA connection;
  - receive call set-up responses from participating SwMI and forward this information to the controlling SwMI CC application;
  - inform the participating SwMI(s) that the call is now to be through connected when indicated by the CC application;
- receive transmission and cease request from participating SwMI(s) and evaluate this information;
  - check for resource availability in participating SwMI(s);
  - inform requesting SwMI(s) of transmission grant, interrupted, ceased, queued or rejected;
  - inform participating SwMI(s) of transmission grant, interrupted or ceased;



- receive information concerning withdrawal or continuation from an active group call from participating SwMI(s) and forward this information to the controlling SwMI CC application.

In this state FE2 may:

- receive indication that a seized ANF-ISIGC entity is to interact with an entity already active for the called group (the calling user shall be merged into the call);
- receive a request from a participating SwMI that it wishes to either be release from the call or it wishes to release the complete call.

From this state FE2 can go to state CALL RELEASE.

#### 6.4.2.5 Void

#### 6.4.2.6 CALL RELEASE

This is the state where the complete call is being released. This state may be used to collect call information, before the call is completely released. In this state FE2 shall:

- wait for confirmation that the call has been released from participating SwMI(s) and the originating SwMI;
- complete the release of the ANF-ISIGC connections.

From this state FE2 can go to state IDLE.

### 6.4.3 States at the participating SwMI

#### 6.4.3.1 IDLE

This is the initial state for the participating SwMI ANF-ISIGC entity. In this state FE3 shall:

- receive set-up information from the controlling SwMI and forward this information to the participating SwMI CC application;
- receive from the participating SwMI CC application and forward to the controlling SwMI information that:
  - the call is ready for through connect;
    - start timer T2 as indicated in clause 6.8;
  - the call has been rejected;
  - the CC application wishes to delay the call set-up;
- release reserved resources upon expiration of timer T2;
- receive indication from the originating SwMI ANF-ISIGC entity for this call that this entity has changed status from originating to participating;
- inform the participating SwMI CC application to connect members of the group call using resources reserved by the originating SwMI ANF-ISIGC entity.

From this state FE3 can go to state WAIT CONNECT, DELAY ENTRY or ACTIVE.

### 6.4.3.2 WAIT CONNECT

This is the state where call set-up has been initiated and the participating SwMI ANF-ISIGC entity is waiting for the call to be through connected. In this state FE3 shall:

- receive indication that the called user is to be through connected and forward this information to the participating SwMI CC application; or
- receive indication that the call is to be delayed and forward this information to the participating SwMI CC application; or
  - receive indication that the participating SwMI CC application has accepted the delay and forward this information to the controlling SwMI;
- receive indication that this SwMI is being released from the call and forward this information to the participating SwMI CC application; or
- receive information from the participating SwMI CC application that the call is to be disconnected in the participating SwMI and forward this information to the controlling SwMI.

From this state FE3 can go to state ACTIVE, DELAY GROUP CALL, CALL DISCONNECT or CALL RELEASE.

### 6.4.3.3 DELAY ENTRY

This is the state used by the participating SwMI ANF-ISIGC entity when the CC application has informed the entity to delay the call set-up. In this state FE3 shall:

- receive information from the participating SwMI CC application that the SwMI is now ready for through connect and forward this information to the controlling SwMI; or
- receive indication that this SwMI is being released from the call and forward this information to the participating SwMI CC application; or
- receive information from the participating SwMI CC application that the call is to be disconnected in the participating SwMI and forward this information to the controlling SwMI.

From this state FE3 can go to state WAIT CONNECT, CALL DISCONNECT or CALL RELEASE.

### 6.4.3.4 DELAY GROUP CALL

This is the state where the participating SwMI ANF-ISIGC entity has been delayed during call set-up. In this state FE3 shall:

- receive set-up information from the controlling SwMI and forward this information to the participating SwMI CC application. The call is no longer delayed; or
  - receive information from the participating SwMI CC application that the call is ready for through connect and forward this information to the controlling SwMI;
  - receive information from the participating SwMI CC application that the CC application wishes to delay the call set-up and forward this information to the controlling SwMI;
- receive indication that this SwMI is being released from the call and forward this information to the participating SwMI CC application; or
- receive information from the participating SwMI CC application that the call is to be disconnected in the participating SwMI and forward this information to the controlling SwMI.

From this state FE3 can go to state WAIT CONNECT, DELAY ENTRY, CALL RELEASE or CALL DISCONNECT.

### 6.4.3.5 ACTIVE

This is the state used by the participating SwMI ANF-ISIGC entity when the call is through connected and active. In this state FE3 shall:

- when requested by the controlling SwMI:
  - poll members of the group call;
    - convey a polling response back to the controlling SwMI;
  - check if resources are available for transmission and reserve these resources. Forward this information to the participating SwMI CC application;
    - inform the controlling SwMI of resource reservation when requested by the participating SwMI CC application;
- receive transmission and cease request from the participating SwMI CC application and inform the controlling SwMI of transmission and cease request;
- receive transmission grant, interrupted, ceased, queued, delayed or rejected information from the controlling SwMI and forward this information to the participating SwMI CC application;
- receive information that the participating SwMI CC application wishes to either withdraw or continue with an active group call and forward this information to the controlling SwMI;
- receive call information from the controlling SwMI and forward this information to the participating SwMI CC application;
- receive an indication from the participating SwMI CC application that call restoration shall be performed and forward this information to the controlling SwMI;
- receive indication that this SwMI is being released from the call and forward this information to the participating SwMI CC application;
- receive information from the participating SwMI CC application that the call is to be disconnected in the participating SwMI and forward this information to the controlling SwMI.

From this state FE3 can go to state CALL DISCONNECT or CALL RELEASE.

### 6.4.3.6 CALL DISCONNECT

The participating SwMI ANF-ISIGC entity is in this state when the CC application has made a request to be disconnected from the call. In this state FE3 shall:

- receive indication that this SwMI is being released from the call and forward this information to the participating SwMI CC application.

From this state FE3 can go to state CALL RELEASE.

### 6.4.3.7 CALL RELEASE

This is the state where the call is being released within a participating SwMI. This state may be used to collect call information, before the call is completely released. In this state FE3 shall:

- wait for confirmation from the participating SwMI CC application that release has been performed;
- complete the release of the ANF-ISIGC connection.

From this state FE3 can go to state IDLE.

## 6.5 ANF-ISIGC signalling procedures

The signalling procedures below specify the conditions under which the SwMI ANF-ISIGC entities send or receive:

- the TETRA ISI PDUs defined in clause 6.3.1; and
- PISN basic call primitives together with some of these TETRA PDUs.

The specific parameters of some of those PISN basic call primitives have been defined in clause 6.2.

To simplify the text below, only the results of those PISN basic call primitives have been specified, e.g. sending of a PSS1 SETUP or CONNECT message.

NOTE: From a formal point of view the SwMI PSS1 protocol control entities are not part of the ANF-ISIGC entities.

The SDL representation showing the behaviour of an ANF-ISIGC entity at the originating SwMI is shown in figures A.1 to A.4, at the group home/controlling SwMI in figures A.5 to A.10 and at the participating SwMI in figures A.11 to A.13.

### 6.5.1 Call set-up procedures

#### 6.5.1.1 Forward set-up request and PISN called number sending

A group call shall be initiated by a primitive sent from the CC application to an ANF-ISIGC entity in the originating SwMI. The ANF-ISIGC entity shall then send the PSS1 SETUP message as defined in clause 6.2.1.1 including the ISI-ORIGINATING SETUP PDU defined in table 24.

The procedures defined in ISO/IEC 11582 [13] for connection oriented, call related connections shall apply. En bloc sending method shall be used.

The information element "Group attachment indicator" in the ISI-ORIGINATING SETUP PDU shall be used to indicate if the calling user is attached to the called group within the originating SwMI. According to the ANF-ISI Mobility Management standard EN 300 392-3-5 [6], the group home SwMI does not necessarily have knowledge of each group attachment made by migrated users in a visiting SwMI.

#### 6.5.1.2 Group linking

When the group home SwMI does not coincide with the controlling SwMI, then the ISI-ORIGINATING SETUP PDU sent from the originating SwMI shall be re-routed to the controlling SwMI (linking home SwMI). An ISI-REROUTE PDU shall be sent from the group home SwMI in a PSS1 RELEASE COMPLETE message or PSS1 DISCONNECT message as defined in clause 6.2.1.2.1 to the originating SwMI. The controlling SwMI MNI shall be indicated in this PDU.

When the calling user is not a member of the called group, i.e. the calling user is not attached to the called group, the information element "Group attachment indicator" shall be set to 1 in the ISI-ORIGINATING SETUP PDU sent from the originating SwMI to the linking controlling SwMI.

When groups are linked, the linking controlling SwMI has no knowledge of the individuals belonging to each group that is linked. Therefore, the originating SwMI shall inform the linking controlling SwMI whether or not the calling user is attached to the called group or not.

#### 6.5.1.3 Call request, information channel selection and PISN called number sending

The controlling SwMI shall evaluate whether the calling user shall be allowed to perform a call to the requested group (received in the ISI-ORIGINATING SETUP) based on whether the calling user is a member of the called group or not, the calling user's profile information if available and on the group attachment indicator received in the ISI-ORIGINATING SETUP PDU.

If the controlling SwMI grants the calling user permission to perform a call to the requested group, group call establishment shall be initiated by a primitive sent from the CC application to an ANF-ISIGC entity in the controlling SwMI. The ANF-ISIGC entity should optionally first inform the originating SwMI of the call status and call set-up time used by the controlling SwMI in an ISI-INFO PDU as defined in table 26. This PDU shall be carried in a PSS1 CONNECT message. The ANF-ISIGC entity shall then initiate group call set-up in the participating and the originating SwMI. A PSS1 SETUP message as defined in clause 6.2.1.3.2 including the ISI-SETUP INITIATE PDU defined in table 25 shall be sent to the participating SwMI(s). The originating SwMI shall receive the ISI-SETUP INITIATE PDU in a PSS1 FACILITY or PSS1 CONNECT message.

NOTE 1: Upon receiving the ISI-INFO PDU, the originating SwMI call control application should inform the air interface CC application of the call status and call set-up time (T302) used in the controlling SwMI.

NOTE 2: If the ISI-INFO PDU is not sent to the originating SwMI, then the ISI-SETUP INITIATE PDU is sent in the PSS1 CONNECT message.

When the calling user is not a member of the called group or the calling user is not attached to the called group in the originating SwMI and the controlling SwMI has evaluated that this user can participate in the requested group call, the information element 'temporary group member indication' shall be set to 1 in the ISI-SETUP INITIATE PDU sent to the originating SwMI. This information element indicates that the calling user shall only have permission to participate in the call, to the connected group, for the duration of the call. Once the calling user disconnects from the group call or is released from the call, a new call set-up sequence shall be performed before this user can participate in a call to the same group.

When it has been evaluated by the controlling SwMI that group profile information is needed for the calling user in the originating SwMI, the information elements 'temporary group basic migration profile' and 'SS-migration profile' shall be sent in the ISI-SETUP INITIATE PDU sent to the originating SwMI. The profiles information sent shall only contain information needed during the call maintenance phase and shall only be valid for the duration of the group call.

The procedures defined in ISO/IEC 11572 [11] for information channel selection, called number sending and call connection shall apply. En bloc sending method shall be used.

#### 6.5.1.4 Call confirmation and call characteristics notification by the originating and participating SwMI(s)

The procedures defined in ISO/IEC 11572 [11] for call confirmation indication and PSS1 call connected shall apply.

Group call acceptance shall be indicated from the CC application in the originating and participating SwMI(s) to its ANF-ISIGC entity invoked for the call. This ANF-ISIGC entity in the participating SwMI shall send a PSS1 CONNECT message as defined in clause 6.2.1.4.2 including the ISI-SETUP ACKNOWLEDGE PDU defined in table 27. This PDU shall be sent in a PSS1 FACILITY message from the originating SwMI. At the same time the ANF-ISIGC entity in the originating and participating SwMI shall start timer T2. The value of this timer shall be sent to the controlling SwMI in the ISI-SETUP ACKNOWLEDGE PDU.

The conditions used by the PSwMI and OSwMI to indicate to the CSwMI that they are ready to be connected into the call are implementation dependent. However, in order to provide predictable behaviour the following strategies are recommended:

- An OSwMI to send in its ISI-Setup-Acknowledge when it has resources to allow a calling party to be connected into the call. The calling party that is ready to connect is indicated in the ISI-Setup-Acknowledge. A PSwMI that becomes an OSwMI because it hosts a new calling party also follows this rule.
- A PSwMI to send back its ISI-Setup-Acknowledge as soon as it has determined that called group members exist at the PSwMI.

Upon expiration of this timer the participating/originating SwMI shall release all resources reserved for the call and request to disconnect. An ISI-DISCONNECT PDU shall be sent to the controlling SwMI in a PSS1 DISCONNECT message.

The participating SwMI may indicate to the controlling SwMI in the ISI-SETUP ACKNOWLEDGE PDU its supported value for the sub-element 'communication type' in the information element 'basic service information' when the value received in the PSS1 SETUP message cannot be support (i.e. normal, acknowledge or broadcast calls). Likewise each SwMI (originating and participating) shall indicate which method of resource allocation is used (temporary or permanent). See table 75.

Group call delay may be indicated from the CC application in the originating SwMI or a participating SwMI to its ANF-ISIGC entity invoked for the call if the SwMI wishes to delay call set-up because it is not ready to be connected. This participating ANF-ISIGC entity shall then send a PSS1 CONNECT message as defined in clause 6.2.1.4.2 including the ISI-DELAY PDU as defined in table 28. This originating ANF-ISIGC entity shall send this PDU in a PSS1 FACILITY message.

#### 6.5.1.5 Call confirmation indication and call connected by the controlling SwMI

The controlling SwMI ANF-ISIGC entity shall send a PSS1 FACILITY message including the ISI-CONNECT PDU defined in table 29 when it decides to connect the call having evaluated call set-up responses from SwMI(s). The conditions used by the CSwMI to connect the call are implementation specific. However to provide the most predictable behaviour the recommendation is that:

- The CSwMI connects the call when it has an OSwMI that has sent in its ISI-Setup-Acknowledge, and thus a calling party, is ready.

At the time of connection the CSwMI may send an ISI-Info PDUs indicating to delaying SwMIs that the call has been connected. The delaying SwMIs may use this information to allow any parties that are already able to join into the call to join it. The delaying SwMI does this by returning an immediate ISI-Setup-Acknowledge PDU.

Upon reception of the ISI-CONNECT PDU in the originating and participating SwMI(s), the timer T2 shall be stopped.

The ISI-Connect indicates which of the calling parties have been elected as the calling party of the call and is the party to which talk permission may be granted. The CSwMI determines which calling parties are "ready", and thus eligible to receive transmission permission, and whether the party wants to talk or not, based on the information passed to the CSwMI in the ISI-Setup-Acknowledge. An OSwMI that receives an ISI-Connect which does not indicate the calling party it indicated in its ISI-Setup-Acknowledge assumes that the calling party has been allocated to another SwMI. All of its parties are joined into the group as called parties only. There is no implied request to talk maintained by the CSwMI for parties that were calling parties of the call but were not elected by the CSwMI as the calling party of the call when it connected the call. Such parties can only be allocated talk permission after sending a new demand to talk.

If the CC application chooses to delay the group call, an ISI-RELEASE PDU as defined in table 45 shall be sent out to the SwMI(s) who had accepted call set-up (ISI-SETUP ACKNOWLEDGE PDU sent to the controlling SwMI). This PDU shall be sent in a PSS1 FACILITY message. At the same time the ANF-ISIGC entity in the controlling SwMI shall start timer T1.

Upon expiration of this timer the controlling SwMI shall release the ISI connections to the delaying SwMI(s). The controlling SwMI shall then either set-up the group call between the delayed SwMI(s) or decide to release all ANF-ISIGC connections.

#### 6.5.1.6 Delay of call set-up

Delaying SwMI(s) may request continuation of call set-up to the controlling SwMI by sending the ISI-SETUP ACKNOWLEDGE PDU as defined in table 27 in a PSS1 FACILITY message. It is recommended that delaying SwMIs do this in accordance with the recommendations outlined in clause 6.5.1.4.

This indication shall be forwarded to the CC application of the controlling SwMI for evaluation. If call set-up already is complete the delaying SwMI shall receive an ISI-CONNECT PDU sent in the PSS1 FACILITY message if connection was allowed by the CC application.

If the CC application indicates that the call set-up now shall continue, in accordance with the recommendation in clause 6.5.1.5, the timer T1 is stopped and call set-up shall be performed to the delayed SwMI(s). An ISI-SETUP-INITIATE PDU shall be sent in a PSS1 FACILITY message. The delayed SwMI(s) can then either respond positive by sending an ISI-SETUP ACKNOWLEDGE PDU or negative by sending an ISI-DELAY PDU in a PSS1 FACILITY message. The delayed SwMI(s) may wish to continue to delay the call. The CC application shall then again evaluate the received responses. The CC application may choose to connect the call (ISI-CONNECT PDU sent in a PSS1 FACILITY message) or delayed it again. If the call is to continue to be delayed, all SwMI(s) who had accepted the call, shall once again receive an ISI-RELEASE PDU as described in clause 6.5.1.5.

The CC application may also choose to continue the delay of the call when a delaying SwMI request for continuation of call set-up. This shall occur when other SwMI(s) have also delayed the call set-up. An ISI-RELEASE PDU shall be sent back to the delaying SwMI, this SwMI shall then become a delayed SwMI. The ISI-RELEASE PDU shall be sent in a PSS1 FACILITY message.

### 6.5.1.7 Failure of call establishment

If the call attempt is rejected by the controlling SwMI (because of e.g. incompatibility basic service information or internal congestion), an ISI-REJECT PDU as defined in table 47 shall be sent to the originating SwMI, with the appropriate reject cause.

If the call attempt is rejected by the originating or a participating SwMI (because e.g. of internal congestion), the ISI-REJECT PDU as defined in tables 43 and 48 shall be sent to the controlling SwMI with the appropriate reject cause. When sent from the originating SwMI the PDU shall be sent in a PSS1 DISCONNECT message. From the participating SwMI the PDU shall be sent in either a PSS1 RELEASE COMPLETE message or a PSS1 DISCONNECT message.

It should be noted that if supplementary service information is to be exchanged during call disconnection, the sending of the PSS1 RELEASE message in response to the PSS1 DISCONNECT message shall be delayed until the supplementary service message sequence is complete.

### 6.5.1.8 Multiple calling parties

It is possible for a call to have multiple calling parties. It is important that no one party can prevent the call from setting up due to a lack of resources. For example, if parties on two different OSwMI call the same group at approximately the same time then there is no reason to wait to connect the call just because the first OSwMI to send in an ISI-Originating-Setup to the CSwMI does not have resources to connect its calling party into the call. This issue is considered under several scenarios.

#### 6.5.1.8.1 A new calling party appears at a SwMI not currently in the group call

In order to support a new calling party appearing when a group call is setting up, the receipt of ISI-Originating-Setup, on a new PSS1 connection, while the call is in any state is supported. The processing of the ISI-Originating-Setup causes the sending back of the ISI-Setup-Initiate and the merging of the new OSwMI into the call.

#### 6.5.1.8.2 A new, compatible, calling party appears at a SwMI where a group call is active

A new, compatible, calling party appearing in a SwMI does not need to send any signalling over the ISI interface. The local call instance joins the party into the call and no signalling is sent to the CSwMI. It is acceptable, but optional, that an ISI-Originating-Setup is sent to the CSwMI.

#### 6.5.1.8.3 A new, compatible, calling party appears at an OSwMI where a group call is still in the setup phase

Since the OSwMI will already have sent in an ISI-Originating-Setup, it is recommended that another ISI-Originating-Setup is not sent to the CSwMI. The sending of an ISI-Originating-Setup is acceptable, but not required.

The OSwMI attempts to get resources so that the new calling party can be connected into the call. The ISI-Setup-Acknowledge is sent to the CSwMI based on the SwMI's strategy for being ready to connect. The readiness of the new calling party should be taken account of in this situation.

The ISI-Setup-Acknowledge sent by an OSwMI always contains the ITSI of a calling party. The CSwMI may choose this party, or another party sent in an ISI-Setup-Acknowledge from another OSwMI, as the calling party of the call indicated in the ISI-Connect. The CSwMI will only physically add the calling party address into the ISI-Connect PDU, when the calling party is different to that sent in the ISI-Setup-Initiate. In this case the "Calling party information present" field will be set to "Calling party information is present".

#### 6.5.1.8.4 A new, compatible, calling party appears at an PSwMI where a group call is still in the setup phase

An ISI-Originating-Setup is sent to the CSwMI on the existing PSS1 connection, the CSwMI does not send a response PDU. The PSwMI now changes its designation to an OSwMI and proceeds as described in the section above. The strategy it uses for sending back its ISI-Setup-Acknowledge is changed from the one appropriate for a PSwMI to the one appropriate for an OSwMI.

The ISI-Originating-Setup may also be sent on a new PSS1 connection.

On receipt of the ISI-Originating-Setup, the CSwMI reclassifies the old PswMI as a new OSwMI.

#### 6.5.1.8.5 A new calling party requesting an emergency call appears at a SwMI where the existing call is not at an emergency priority

If an emergency priority call is received, for a group that is already known to be in a group call at a non emergency priority, then a new PSS1 connection is used to send an ISI-Originating-Setup to the CSwMI. The CSwMI disconnects the existing call and sets up the new emergency call to the same group.

The SwMI of the new calling party may choose to release the existing call, prior to being told to do so by the CSwMI.

#### 6.5.1.8.6 A new, non compatible, calling party appears at a SwMI where a group call is already active

If a SwMI decides that a new calling party is not compatible with an existing group call then the SwMI will not join the new party into the call. No ISI signalling is involved in this case.

The decision as to what is, and what is not a compatible call is a SwMI dependent matter, reasons could be:

- The new calling party is not a member of the group.
- Incompatible priority (below emergency).
- Data call requested.
- Incompatible SS-Facility.
- Resources not available.
- Others.

Once a SwMI has accepted a new calling party as able to call the group then no other SwMI may reverse that decision.

#### 6.5.1.8.7 A new calling party appears at a CSwMI that only supports a single ISI-Originating-Setup

A CSwMI receiving a further ISI-Originating-Setup when it does not support more than one may reject, with an ISI-Reject, the additional call request.

#### 6.5.1.8.8 The sending of subsequent ISI-Originating-Setups to the CSwMI

When it is possible to send another ISI-Originating-Setup to the CSwMI this can be done in one of two ways:

- The ISI-Originating-Setup may be sent on the existing PSS1 connection for the call. In this case the CSwMI will not respond to the ISI-Originating-Setup. The ISI-Originating-Setup is sent in a PSS1 FACILITY message. In order to achieve this the sending SwMI will already have locally merged the new call into the existing call.
- The ISI-Originating-Setup may be sent on a new PSS1 connection, in a PSS1 SETUP message, to the CSwMI. In this case the CSwMI will respond, also on the new PSS1 connection, with an ISI-Setup-Initiate. Since the call is already active in the CSwMI, the CSwMI will set the "call amalgamation" information element to "Call has been amalgamated" in the ISI-SETUP-INITIATE PDU. The SwMI receiving the ISI-SETUP-INITIATE PDU will merge the call with the existing call to the same group that it already has running. The older PSS1 connection will be used for the merged call. It is the responsibility of the CSwMI to clear down the new PSS1 connection. This is done by sending the ISI-SETUP-INITIATE PDU in a PSS1 DISCONNECT message.

NOTE: The only mandatory uses of a subsequent ISI-ORIGINATING-SETUP PDU are when a PswMI turns into an OSwMI during call setup, and when an emergency call is started in a SwMI already having a call to the same group at a non emergency priority. It is recommended that these are the only times a subsequent ISI-ORIGINATING-SETUP PDU is used.



### 6.5.1.9 Security level

The "Security level at air interface" information element in ISI-Originating-Setup , ISI-Setup-Initiate, ISI-Setup-Acknowledge and ISI-Connect PDU shall be used as follows:

- OSwMI informs the current (default) security level of the group at air interface in ISI-Originating-Setup PDU to CSwMI.
- CSwMI informs the security level that is recommended to be used in all SwMIs for the group call at air interface in ISI-Setup-Initiate to OSwMI and PSwMI.
- OSwMI and PSwMI inform the same security level that was recommended to be used in all SwMIs for the group call in ISI-Setup-Acknowledge PDU to CSwMI. However, if the nominated SwMI is not able to follow the recommendation, the OSwMI/PSwMI shall indicate the security level it is capable for the group.
- CSwMI then informs the security level that shall be used in the OSwMI and PSwMIs for the group call in ISI-Connect PDU and all the SwMIs shall follow it. The CSwMI may downgrade the security level to clear if some SwMI does not support air interface encryption for the group or CSwMI may leave the SwMIs out of the call if in those SwMIs the security level in the air interface is not sufficient.

### 6.5.2 Acknowledge group call

The controlling SwMI may poll group members after call set-up, by sending an ISI-POLL USER PDU (see table 30) to participating SwMI(s) as described in stage 1, clause 4.2.2.3.5. This PDU shall be sent in a PSS1 FACILITY message. Participating SwMI(s) shall poll group members when requested by the controlling SwMI and return the requested polling response to the controlling SwMI in an ISI-POLL RESPONSE PDU sent in a PSS1 FACILITY message.

If the calling user has requested transmission and is not granted transmission during call set-up, the information element 'transmission grant' in the ISI-CONNECT PDU shall indicate that the transmission request is queued. When the controlling SwMI decides that the calling user shall receive permission to transmit, a solicited ISI-TX GRANTED PDU shall be sent to the calling user indicating that transmission has now been granted.

The controlling SwMI may inform the participating SwMI(s) of the poll result by using an ISI-INFO PDU as defined in table 32. This PDU shall also be sent in a PSS1 FACILITY message.

### 6.5.3 Call maintenance procedures

No ISI hang timer exists for releasing the ISI connection between the controlling and participating SwMI(s). The ISI connection shall be permanently available for the duration of the call. The ISI connections shall only be release when the controlling SwMI or a participating SwMI initiates a full or partial group call release.

#### 6.5.3.1 Transmission control procedures

##### **Transmission Request**

When a transmission request is received in a participating SwMI, this request shall be forwarded to the controlling SwMI ANF-ISIGC entity in an ISI-TX DEMAND PDU as defined in table 34. This PDU shall be sent in a PSS1 FACILITY message. Depending on the result of the received request (see clause 4.2.2.3.7) in the controlling SwMI, the following actions shall be taken.

##### **Transmission Response**

If another transmission is ongoing and the requesting user is allowed to interrupt the transmission, an ISI-TX INTERRUPT PDU, as defined in table 40, shall be sent to both the requesting SwMI and to all other participating SwMIs when transmission is granted.

If transmission is to be granted to the requesting user and no other transmission is active, resource allocation shall be performed in SwMI(s) with temporary allocated resources. An ISI-RESOURCE PDU (table 36) shall be sent to the participating SwMI(s) in a PSS1 FACILITY message. If the SwMI could reserve resources for the new transmission, then this SwMI shall indicate so in the ISI-RESOURCE RESPONSE PDU in a PSS1 FACILITY message. Otherwise an indication that resources could not be reserved, shall be sent in the same PDU. Together with the resources not reserved indication, a participating SwMI may request the controlling SwMI to delay transmission granting if it is known by the participating SwMI that resources will be available within a short period of time. The controlling SwMI CC application shall re-evaluate if transmission is to be granted, delayed or rejected when resources were not available. The ISI-TX GRANTED PDU, as defined in table 39, shall be sent to both the requesting SwMI and to all other participating SwMIs if transmission is granted.

When transmission has been rejected or queued by the controlling SwMI the ISI-TX GRANTED PDU, as defined in table 39, shall be returned to the requesting SwMI with the appropriate transmission not granted cause.

Each time transmission is granted to a new user, the ANF-ISIGC entity in the controlling SwMI should check if any SwMI(s) with group members not currently participating in the active call, exist. If so, a group call connection shall be established towards these SwMI(s) as defined in clause 6.5.1 before transmission is granted to the requesting user.

NOTE 1: Transmission delay, due to new participating SwMIs requesting call set-up delay, may occur.

If the controlling SwMI decides to delay transmission, all new participating SwMIs shall be released without releasing the ISI connection to them, i.e. this is the same procedure as delay during call set-up. Each participating SwMI with temporary allocation of resources shall receive an ISI-TX CEASED PDU to enable them to free up the resources they had just reserved. The information element 'transmission ceased' in the ISI-TX CEASED PDU shall be set to "Delay transmission request". The participating SwMI where the requesting user is located should not inform the requesting user of transmission delay.

NOTE 2: Only participating SwMI(s) with temporary allocation of resources and new participating SwMI(s) will be informed of the transmission delay.

Upon reception of the ISI-TX CEASED PDU with a delay indication, each participating SwMI shall release all resources reserved during the ISI-RESOURCE / ISI RESOURCE RESPONSE sequence. The participating SwMI should return to the same state as just before the ISI-RESOURCE / ISI RESOURCE RESPONSE sequence.

The ANF-ISIGC entity in the controlling SwMI shall initiate the T3 timer when transmission delay is to occur. The timer is used to either:

- release ISI channel resources to new participating SwMI(s) and initiation of call release to all active SwMIs, if no response is received from the delaying SwMI within a certain period of time;
- grant transmission to the requesting user after a new set of resource reservation sequences has been performed and new participating SwMI(s) have been set-up in the call; or
- grant transmission permission to another user. In this case, call set-up to the new participating SwMI(s) and resource reservation sequences will be performed again.

When the delaying SwMI has the necessary resources available to perform the transmission, the delaying SwMI shall send the ISI-RESOURCE RESPONSE again. The 'Resource indicator' information element shall now be set to 'Resources are reserved'.

NOTE 3: If the delaying SwMI determines that resources could not be acquired before time out of T3, the SwMI may send the ISI-RESOURCE RESPONSE PDU with the 'Resource indicator' information element set to 'Resources could not be reserved'. The controlling SwMI will then stop T3, remove the transmission request and may grant transmission to any other requesting user.

Upon reception of the ISI-RESOURCE RESPONSE PDU from the delaying SwMI, the controlling SwMI shall request each participating SwMI with temporary allocated resources to reserve resources for transmission once again and set-up the call to each new participating SwMI.

### Transmission Ceased

When a cease of transmission request is received in a participating SwMI, this request shall be forwarded to the controlling SwMI ANF-ISIGC entity in an ISI-TX CEASED PDU as defined in table 38. This PDU shall be sent in a PSS1 FACILITY message. Depending on the result of the received request (current transmission is ceased or a queued transmission request has been granted permission to transmit) in the controlling SwMI, the requesting SwMI may either receive an ISI-TX CEASED PDU as defined in table 38 or an ISI-TX GRANTED PDU. If a queued transmission request has been removed from the transmission queue, then no response to the ISI-TX CEASED PDU shall be sent from the controlling SwMI to the requesting SwMI.

### Transmission Wait/Continue

When a participating SwMI wishes to withdraw from an active group call or rejoin an active group call, an ISI-TX WAIT PDU as defined in table 42 or an ISI-TX CONTINUE PDU shall be sent to the controlling SwMI. The PDU shall be sent in a PSS1 FACILITY message.

### Throttling of Demands

It is recommended that a CSwMI limits the number of transmit demands which it queues. To avoid unnecessary loading on the CSwMI it is also recommended that a PSwMI limit the number of simultaneous demands that it has outstanding with the CSwMI. Any demand that cannot be passed to the CSwMI can be rejected back to the demanding party.

### 6.5.3.2 Call modification and/or continuation

The controlling SwMI may wish to inform the participating SwMI(s) a change in the call time-out time. When requested by the CC application of the controlling SwMI, the ANF-ISIGC entity shall send an ISI-INFO PDU to the participating SwMI(s) as defined in table 32. This PDU shall be sent in a PSS1 FACILITY message.

The same PDU carried in the PSS1 FACILITY message may also be used to request call modification in the participating SwMI(s) (as specified in clause 14.5.2.2 of EN 300 392-2 [3]).

If the received modifications cannot be accepted by the SwMI, an ISI-DISCONNECT PDU as defined in table 44 shall be returned to the controlling SwMI. This PDU shall be carried in a PSS1 DISCONNECT message.

If a participating SwMI changes its local call identity during a call, the participating SwMI shall inform the controlling SwMI of the new call identity in an ISI-INFO PDU.

### 6.5.3.3 Call restoration

NOTE 1: Call Restoration is subject to further study. The current proposals outlined here do not work in general situation. This is because there is no requirement in EN 300 392-2 [3] to have a single unique call identifier for a group call in a SwMI. However, what is written here assumes that there is.

Upon reception of a U-CALL RESTORE PDU from a migrated user, the SwMI shall send an ISI-CALL RESTORATION PDU to the controlling SwMI in either a PSS1 SETUP or PSS1 FACILITY connection orientated, call independent message. The call restoration PDU shall contain the call identity of the previous visiting SwMI, the MNI of this SwMI and an indication as to whether transmission is requested or not.

NOTE 2: The U-CALL RESTORE PDU is carried over the air interface in the lower layer MLE PDU U-RESTORE. The MLE PDU will always contain the previous SwMI MNI and LA information when the MNI and LA of the new cell differ from that of the old cell.

NOTE 3: The same rules for transmission handling apply during migration as apply during roaming. See clause 14.5.2.2.4 of the air interface standard EN 300 392-2 [3].

When an ISI-CALL RESTORATION PDU is received in a SwMI that is not the controlling SwMI for the group indicated in the PDU, an ISI-REROUTE PDU shall be returned to the new SwMI with an indication as to who the controlling SwMI of the call is. This may occur when group linking has been performed.

The controlling SwMI CC application shall evaluate whether the migrated user is allowed to continue participation in the indicated group call. Upon call restoration acceptance, the controlling SwMI shall set-up a new ISI connection to the new participating SwMI using normal call set-up procedures, if the call does not already exist at the new participating SwMI. The ISI-CALL RESTORATION ACK PDU shall be returned to the new participating SwMI on the same call unrelated connection as the ISI-CALL RESTORATION PDU was received on, following successful call set-up.

When the migrated user is only allowed to participate in the given call for the duration of this call, the information element 'temporary group member indication' shall be set to 1 in the ISI-CALL RESTORATION ACK PDU. When it has been evaluated by the controlling SwMI that group profile information is needed for the migrated user in the participating SwMI, the information elements 'temporary group basic migration profile' and 'SS-migration profile' shall also be sent in the ISI-CALL RESTORATION ACK PDU. The profiles information sent, shall only be valid for the call restoring user for the duration of the group call.

Following call restoration to the new SwMI, call release shall be performed towards the old SwMI, if the last user participating in the group call has migrated. The ANF-ISIGC entity in the controlling SwMI shall send an ISI-RELEASE PDU in a PSS1 DISCONNECT message to the old SwMI. The old SwMI shall then confirm call release by sending the PSS1 RELEASE message to the controlling SwMI. Confirmation that the PSS1 connection has been released is sent to the old SwMI by sending a PSS1 RELEASE COMPLETE message.

It should be noted that if supplementary service information is to be exchanged during call disconnection, the sending of the PSS1 RELEASE message in response to the PSS1 DISCONNECT message shall be delayed until the supplementary service message sequence is complete.

If the migrated user's call restoration request fails and this user is either the call owner or a critical user the controlling SwMI may decide to disconnect the call. Otherwise the ISI-CALL RESTORATION NACK PDU shall be returned to the new SwMI with the failure cause.

NOTE 4: When the call owner is no longer participating in the group call the controlling SwMI should release the complete call.

#### 6.5.3.4 DTMF procedures

The DTMF information shall be sent over the ISI in a PSS1 FACILITY message including the ISI-INFO PDU defined in table 33 (see also clause 6.5.2.2).

NOTE: According to ISO/IEC 11582 [13], a PSS1 FACILITY can only be sent by the originating SwMI after a PSS1 signalling path has been established (i.e. a first PSS1 message has been received from the controlling SwMI, e.g. PSS1 ALERTING or CONNECT message). This originating SwMI will therefore have to store the DTMF information that it has received until the signalling path is established. According to EN 300 392-2 [3], the air interface U-INFO PDU can carry DTMF information as soon as a call reference has been allocated by the (originating) SwMI.

#### 6.5.4 Call disconnection procedures

When the originating SwMI or a participating SwMI wishes to be disconnected from the group call, an ISI-DISCONNECT PDU shall be sent to the controlling SwMI in a PSS1 DISCONNECT message. This information is forwarded to the CC application in the controlling SwMI for evaluation.

NOTE 1: The originating SwMI may wish to be released from the call after sending the ISI-SETUP ACKNOWLEDGE PDU but before the ISI-CONNECT PDU is received.

The CC application may choose to release the requesting SwMI or release the complete call. If only the release requesting SwMI is to be released, an ISI-RELEASE PDU shall be sent to this SwMI in a PSS1 RELEASE message. Upon call release, this SwMI shall then confirm that release is complete by sending a PSS1 RELEASE COMPLETE message to the controlling SwMI.

NOTE 2: When the disconnection request has been sent from the call owner, the complete call is always released (the information element 'call owner request' has been set in the ISI-DISCONNECT PDU).

If the complete call is to be released, an ISI-RELEASE PDU shall be sent out to all SwMI(s) participating in the group call. The PDU shall be carried in a PSS1 RELEASE message to the release requesting SwMI and a PSS1 DISCONNECT message to all other SwMI(s). Upon call release, the released requesting SwMI shall send a PSS1 RELEASE COMPLETE message to the controlling SwMI and all other SwMI(s) shall send a PSS1 RELEASE message. Confirmation that the PSS1 connection has been released is sent back to the released SwMI(s) by sending a PSS1 RELEASE COMPLETE message.

When the group call is release upon request from the CC application in the controlling SwMI, the same procedures as described for complete call release above shall be performed.

No TETRA PDU shall be included in the case of call clearing by the PSS1 network (PSS1 RELEASE COMPLETE).

In some implementations of group calls there may be more than one calling party. The CSwMI does not allocate call ownership to the OSwMI in the ISI-Setup-Initiate. Nevertheless, if a calling party disconnects during call set-up, it will send a U-DISCONNECT PDU to the SwMI because the MS is not informed whether it is the owner or not until it receives a D-CONNECT PDU. If there are other calling parties in the call, then the call should not clear because another party may become the calling party, and the called group member parties on the OSwMI are still required to be in the call. To achieve this, if a calling party disconnects, and that party is not the only calling party on the OSwMI, then the OSwMI may optionally send in an ISI-DISCONNECT PDU. However, if it does so the "call owner request" field must not be set. If, however, the party is the only calling party on the OSwMI, then the OSwMI should send an ISI-DISCONNECT PDU indicating that the disconnection was requested by a call owner to the CSwMI. The CSwMI should disconnect the call only if there are no other OSwMIs in the call.

If a disconnecting SwMI knows that the call is to be cleared in the disconnecting SwMI, then it can initiate the clearing before sending the ISI-Disconnect to the CSwMI. The underlying PSS1-DISCONNECT message is used in this case. Otherwise, the disconnecting SwMI would send its ISI-DISCONNECT PDU in a PSS1 FACILITY message. The CSwMI will determine if the P/OSwMI is to be removed from the call, if it does then an ISI-RELEASE PDU will be sent from the CSwMI in a PSS1 DISCONNECT message.

The CSwMI may release the call at any time. After the call is active, PSwMIs may disconnect when there are no longer any active parties on the SwMI.

It should be noted that if supplementary service information is to be exchanged during call disconnection, the sending of the PSS1 RELEASE message in response to the PSS1 DISCONNECT message shall be delayed until the supplementary service message sequence is complete.

### 6.5.5 Call collisions

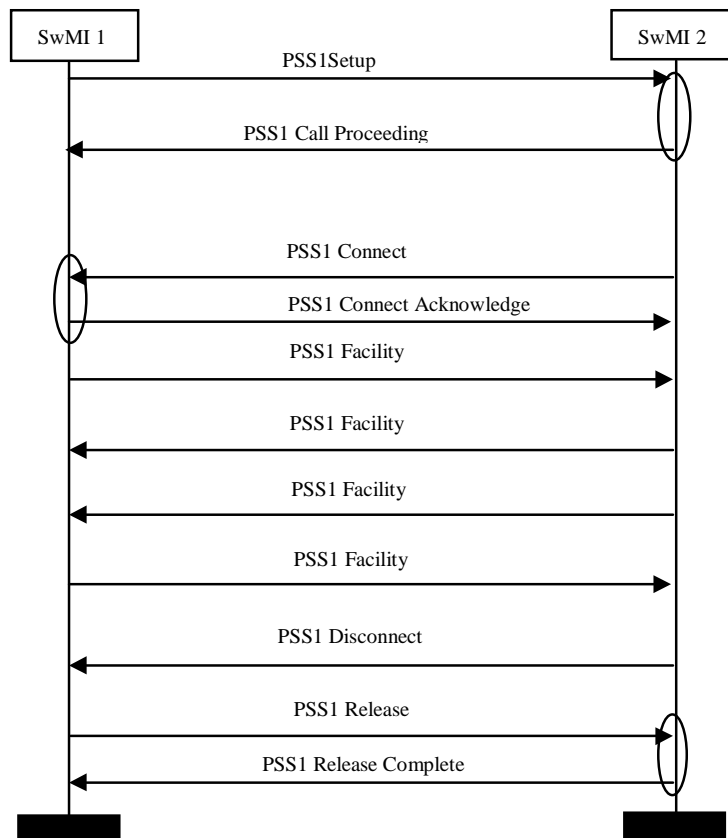
In the case of call collision because two adjacent PISN nodes (including SwMIs involved in the call establishment or restoration) both attempt to seize the same PISN B<sub>Q</sub> channel the procedure defined in ISO/IEC 11572 [11] for call collision shall apply.

See stage 1 clause 4.2.2.3.6, for the description of colliding calls between two originating SwMI(s).

### 6.5.6 Mapping of PSS1 messages with ISI PDUs.

The set-up of the PSS1 call is driven by the set up of the ISI call. The first ISI PDU to be sent goes in the PSS1 SETUP message, the second, providing it is not a disconnect case, goes in the PSS1 CONNECT message, etc. Note that an ISI call set-up may initiate the set-up of several PSS1 calls.

The figure 72 shows the PSS1 messages for a typical ISI call between two SwMIs.



**Figure 72: PSS1 messages for a typical ISI call between two SwMIs**

- 1) The PSS1 CALL PROCEEDING and PSS1 CONNECT ACKNOWLEDGE messages do not carry ISI PDUs.
- 2) The PSS1 ALERTING message is not used in the set-up of an ISI group call.
- 3) The ISI call cannot be connected before the PSS1 call is connected.
- 4) After PSS1 call connection, PSS1 FACILITY messages are used to carry further signalling for the ISI call (e.g. call maintenance signalling). There is no set ordering or direction of travel for PSS1 FACILITY message.
- 5) It is not possible to use a PSS1 FACILITY message before a PSS1 CONNECT message. This is because the setup of the ISI call drives the set up of the PSS1 call.
- 6) The PSS1 DISCONNECT message may be in either direction resulting in a change of direction for the PSS1 RELEASE and PSS1 RELEASE COMPLETE messages shown in the figure 72.
- 7) The PSS1 call may be disconnected any time after the PSS1 CALL PROCEEDING message has been sent.
- 8) If a disconnecting SwMI is clearing the call in the disconnecting SwMI then it must instruct the PSS1 software to send the ISI-DISCONNECT PDU in a PSS1-DISCONNECT message. Otherwise, it must instruct the PSS1 software to send the ISI-DISCONNECT PDU in a PSS1-FACILITY message.
- 9) The PSS1 software must indicate the type of PSS1 message in which an ISI PDU was received. This enables the CSwMI to distinguish between an ISI-DISCONNECT PDU received when the sending SwMI has not already initiated local clearing of the call and an ISI-DISCONNECT PDU received when the sending SwMI has already initiated local clearing of the call.
- 10) It is possible to respond to a PSS1 SETUP message with a PSS1 RELEASE COMPLETE message to clear the PSS1 call.
- 11) The Originating SwMI, or PSS1 calls initiated by the CSwMI (to PSwMIs), may release a PSS1 call before receiving a PSS1 CALL PROCEEDING message with a PSS1 RELEASE message (to which the called SwMI responds with a PSS1 RELEASE COMPLETE message).

- 12) The ISI-RELEASE PDU is sometimes sent in a PSS1 RELEASE message. This occurs when the CSwMI receives an ISI-DISCONNECT PDU in a PSS1 DISCONNECT message. Since the PSS1 RELEASE message does not have end to end significance, there is a high probability that any ISI PDU sent in a PSS1 RELEASE message will not arrive at the destination SwMI. However, since the call is disconnecting when the ISI-RELEASE message is sent, and no useful information is carried in the PDU (the "disconnect cause" comes from the receiving SwMI) the probable loss of the ISI-RELEASE PDU, in these circumstances, is considered acceptable.

## 6.6 ANF-ISIGC impact from interworking with ISDN/PISN/PSTN

### 6.6.1 Call set-up procedures

For an external incoming group call (i.e. to a TETRA group) routed over the ISI, the incoming gateway shall send the number of the calling party in the external network, if available, to an invoked ANF-ISIGC entity in the originating SwMI. This entity shall then forward the group call request in an ISI-ORIGINATING SETUP PDU as defined in table 24 to the controlling SwMI. This PDU shall also include PSS1 information elements (notably the progress indicator elements) as defined in clause 6.2.1.5.1. Call set-up shall then continue in the controlling SwMI as described in clause 6.5.1.

NOTE 1: It is assumed that the group home SwMI and the controlling SwMI coincide.

However, the following exceptions to clause 6.2.1.5.1 shall apply:

- the controlling SwMI shall provide the external subscriber number and the incoming gateway identity (calling party identity information element) in the ISI-SETUP INITIATE PDU;
- when the incoming gateway is the only participant in the group call at the originating SwMI, then resource reservation shall always be set to permanent resource allocation;

NOTE 2: If new group members join the call in this SwMI, e.g. due to migration or late entry, resource reservation may be changed to temporary resource allocation by indicating so in the ISI-SETUP ACKNOWLEDGE or in an ISI-INFO PDU.

- the controlling SwMI shall always give call ownership to the incoming gateway entity, to ensure that when the external calling user wishes to release the call, the complete call is released;
- call set-up shall not be delayed when the calling user is an external user.

### 6.6.2 Call maintenance procedures

The calling user may send a request to transmit or a request to cease transmission to the controlling ANF-ISIGC entity either by sending explicit requests through the external network or by using a voice detection mechanism at the incoming gateway to generate transmission cease and requests.

NOTE 1: The exact mechanisms for voice detection and its algorithm are outside the scope of the present document.

To ensure that the external calling user can receive transmission grant before starting to speak, transmission shall always be granted to this user when no other called group member is transmitting. Therefore, when the controlling SwMI receives an ISI-TX CEASED PDU, it shall always respond with an ISI-TX GRANTED PDU to either queued request from TETRA users or to the external calling user.

NOTE 2: Transmission is always granted to requesting TETRA users before granting transmission to the external calling user.

If a TETRA user requests permission to transmit while the external calling user is transmitting, transmission shall be interrupted towards the external calling user and transmission granted to the requesting TETRA user.

### 6.6.3 Call disconnection procedures

See clause 6.5.4.

## 6.7 Protocol interaction between ANF-ISIGC and supplementary services and other ANFs

### 6.7.1 Call Forwarding Unconditional (SS-CFU)

ANF-ISIGC shall interact with SS-CFU when a group call is forwarded to a group located in a SwMI other than the called group's home SwMI.

When the called group's home SwMI does not coincide with the forwarded to group's home SwMI, then an ISI-REROUTE PDU as defined in table 46 shall be sent in a PSS1 RELEASE COMPLETE or PSS1 DISCONNECT message back to the originating SwMI. To re-route the call, the ANF-ISIGC entity in the originating SwMI shall initiate a new call establishment, using the group home SwMI MNI received in the ISI-REROUTE PDU.

NOTE 1: If the calling user and the called group have the same home SwMI and the calling user has not migrated, the call will be an intra-TETRA call. In such cases, if SS-CFU is activated for the called group and if the forwarded-to group is registered in a different SwMI, SS-CFU will invoke an ANF-ISIGC for the establishment of the call.

NOTE 2: When SS-CFU is invoked for a call, i.e. for a group, the SS-CFU notification information is transported transparently between group home SwMI(s) or between the group home SwMI and the originating SwMI.

When a group call request is forwarded unconditionally to an individual, then the group home SwMI shall invoke ANF-ISIIC. ANF-ISIIC shall then consider the ISI-ORIGINATING SETUP PDU sent from the originating SwMI as an individual call set-up indication.

### 6.7.2 Call Authorized by Dispatcher (SS-CAD)

When SS-CAD is invoked for an incoming group call and the operation of SS-CAD entails the establishment of a call between the calling user and the dispatcher (i.e. diversion to the dispatcher) and the calling user is located in a SwMI other than the restricted groups home SwMI, a group call set-up shall be made between the calling user in the originating SwMI and the dispatcher. (See clause 6.5.1 for call set-up.) When sending the ISI-SETUP INITIATE PDU to the originating SwMI, the information element 'Call diverted to dispatcher' shall be set. This information element shall be used to indicate to the originating SwMI that SS-CAD has been invoked by the group home SwMI for the called group and direct set-up shall be made to the dispatcher.

NOTE 1: This caters for the case where the originating SwMI does not support SS-CAD.

Upon reception of the TETRA PDU ISI-CONNECT (defined in table 29), the originating SwMI shall however, remain to exist. The originating SwMI shall not change status to a participating SwMI and any called group members located in the SwMI shall not be connected.

The originating SwMI shall only upon reception of the TETRA PDU ISI-THROUGH CONNECT (defined in table B.1 in annex B) sent from the controlling SwMI change status to a participating SwMI and connect any called group members located in the SwMI. At this point the originating SwMI shall cease to exist. Even though the originating SwMI does not support SS-CAD, the TETRA PDU ISI-THROUGH CONNECT shall be supported.

When the dispatcher is located in a SwMI other than the restricted groups home SwMI in the case above, call set-up to this dispatcher shall be performed as described in EN 300 392-11-6 [8].

NOTE 2: When the calling user is located in the restricted groups home SwMI and the dispatcher is located in another SwMI, SS-CAD will invoke ANF-ISIIC to the dispatcher as described in EN 300 392-3-2 [5].

When the operation of SS-CAD does not entail the establishment of a call between the calling user and the dispatcher (i.e. interception by the dispatcher), only the PISN connection shall be through connected. This connection shall be used to inform the calling user of acceptance or rejection by the dispatcher or of a possible diversion to the dispatcher. The TETRA call set-up shall continue depending upon the received response.

NOTE 3: See annex B for information flow diagrams describing the interaction between ANF-ISIGC and SS-CAD.



### 6.7.3 Area Selection (SS-AS) and selected area number

The information element "selected area number" shall be carried in the TETRA ISI-ORIGINATING SETUP PDU sent in the PSS1 call related SETUP message. The "selected area number" information element carries the same information as the "area selection" in the air interface, but adapted to the ISI signalling. The information element shall be used by the group/linking home SwMI during call set-up, in the cases of late entry and may be used during call restoration.

### 6.7.4 Priority Call (SS-PC)

If SS-PC has been activated and call set-up operates by queuing, then each group call shall be established according to the queuing mechanism implemented in the SwMI(s) for priority.

The calling user shall send the call priority level to the controlling SwMI in the ISI-ORIGINATING SETUP PDU when the calling user is not located in the called group's home SwMI. The controlling SwMI may then accept this priority level or change it. The priority level given for the call shall be sent in the ISI-SETUP INITIATE PDU.

### 6.7.5 Pre-emptive Priority Call (SS-PPC)

SS-PPC shall interact with ANF-ISIGC to pre-empt an inter-TETRA connection with the lowest CRV among those which may be used to route the priority call. SS-PPC shall invoke pre-emption by forcing the clearing of the chosen inter-TETRA connection. An ISI-RELEASE PDU shall be sent out to participating SwMI(s) being released from the group call (see clause 6.5.4 for complete release of a group call). The controlling SwMI shall then invoke a new ANF-ISIGC at the corresponding ISI by sending an ISI-SETUP INITIATE PDU (see clause 6.5.1 for call set-up sequence).

NOTE 1: The correct time to tear down the inter-TETRA connections and allocate new inter-TETRA connections, should be when the controlling SwMI has received positive indication back from the participating SwMI that it can and will support the group call (ISI-SETUP ACKNOWLEDGE PDU sent from the participating SwMI(s)).

NOTE 2: When a call extends between several TETRA systems, different call retention values may be used for resources allocated within each system. SwMIs should therefore, give its own resources lower call retention values than resources owned by other SwMIs. This then insures that a SwMI will always pre-empt its own resources.

### 6.7.6 Include Call (SS-IC)

When the group call owner wishes to include a user or group of users who are not members of the active group call and who are registered in a SwMI other than the controlling SwMI, call set-up shall be initiated by sending an ISI-SETUP INITIATE PDU as defined in table 25 from the controlling SwMI ANF-ISIGC entity. This TETRA PDU shall be carried in a PSS1 SETUP message if no inter-TETRA connection to the new SwMI exists.

NOTE: The controlling SwMI approves always approve the inclusion of a user or group of users before call set-up is initiated towards the specified user(s).

Group call acceptance shall be indicated from the CC application in the new participating SwMI(s) to its ANF-ISIGC entity invoked for the call. This ANF-ISIGC entity shall send a PSS1 CONNECT message as defined in clause 6.2.1.4.2 including the ISI-SETUP ACKNOWLEDGE PDU.

The controlling SwMI ANF-ISIGC entity shall then send a PSS1 FACILITY message including the ISI-CONNECT PDU defined in table 29 when call set-up responses from the participating SwMI(s) have been evaluated by the CC application in the controlling SwMI and call confirmation has been indicated.

If an inter-TETRA connection already exists the above TETRA PDUs shall be carried by a PSS1 FACILITY message. See clauses 6.5.1.4 to 6.5.1.7 for a complete description of call set-up procedures.

### 6.7.7 Call Retention (SS-CRT)

The CRV is dynamically assigned by a SwMI, to inter-TETRA connection used to route the group call. This value may differ in SwMIs using the same inter-TETRA connection for the group call. The CRV is only known locally within the SwMIs.

### 6.7.8 Interactions with other supplementary services

At the time the present document was written, no other supplementary service has been identified which could require for its invocation or its operation of an interaction with ANF-ISIGC.

NOTE: Such supplementary services require only the transport of their PDUs (i.e. SS PDUs) through ANF-ISISS, as defined in clauses 9 and 10 of EN 300 392-9 [i.2].

## 6.8 ANF-ISIGC parameter values (timers)

ANF-ISIGC shall use the mandatory timers defined in ISO/IEC 11572 [11]. It shall not use the optional PSS1 timer T301 (for the outgoing side, started by the reception of the PSS1 ALERTING message). This timer might conflict with the call set-up phase TETRA timer T302. Nor shall ANF-ISIGC use the optional timer T313 (for the incoming side, started when sending PSS1 CONNECT). PSS1 CONNECT ACKNOWLEDGE is not used for group calls over the ISI.

ANF-ISIGC shall use timer T1 as defined in clauses 6.5.1.5 and 6.5.1.6 when a group call is delayed. The timer is used to release ISI channel resources and delaying SwMI(s), if no response is received from the delaying SwMI within a certain period of time. The value of this timer shall be 30 s.

ANF-ISIGC shall use timer T2 as defined in clauses 6.5.1.4 and 6.5.1.5 when an ISI-SETUP ACKNOWLEDGE PDU is sent from the originating or participating SwMI(s). The timer is used to release air interface, mobile and infrastructure resources if no ISI-CONNECT PDU is received from the controlling within a certain period of time. The minimum value of this timer shall be 5 s, and its maximum value, 30 s.

ANF-ISIGC shall use timer T3 as defined in clauses 6.5.3.1 when a transmission request is delayed. The timer is used to either continue transmission handling or to release the group call, when no response is received from the delaying SwMI within a certain period of time. The minimum value of this timer shall be 5 s, and its maximum value, 15 s.

The ISI connection shall be permanently available for the duration of the call. Therefore, no ISI hang timer exists for releasing the ISI connection between the controlling and participating SwMI(s).

---

## Annex A (normative): Specification and Description Language (SDL) representation of procedures

The diagrams in this annex use the Specification and Description Language defined in ITU-T Recommendation Z.100 [i.5].

The diagrams represent the behaviour of ANF-ISIGC entities within each SwMI participating in a group call.

At a SwMI, an output symbol represents a primitive. The output primitive results from an ANF-ISIGC PDU being received. The output primitive bears the name of the received ANF-ISIGC PDU.

When needed, the following abbreviations are used:

- CNNCT for CONNECT;
- DMD for DEMAND;
- GRT for GRANTED;
- IRT for INTERRUPT.

---

### A.1 SDL representation of an ANF-ISIGC entity at FE1

Figures A.1 to A.4 show the behaviour of an ANF-ISIGC entity at the originating SwMI.

The following conventions are used:

- the input signals from the left represent primitives from the originating SwMI call control application;
- the output signals to the left represent primitives to the originating SwMI call control application;
- the input signals from the right represent primitives from the group home/controlling SwMI ANF-ISIGC entity;
- the output signals to the right represent primitives to the group home/controlling SwMI ANF-ISIGC entity.

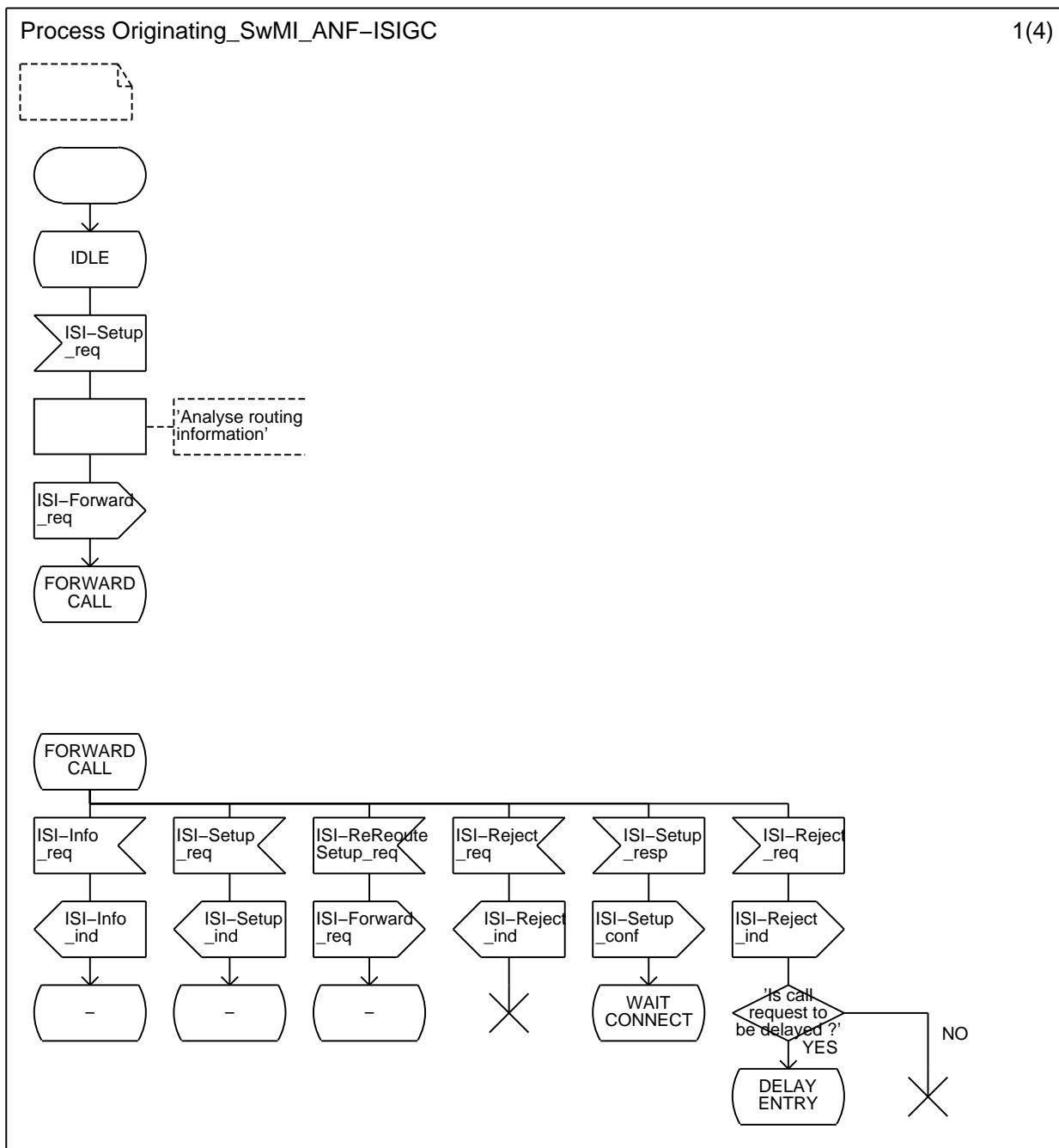


Figure A.1: SDL for originating SwMI ANF-ISIGC entity

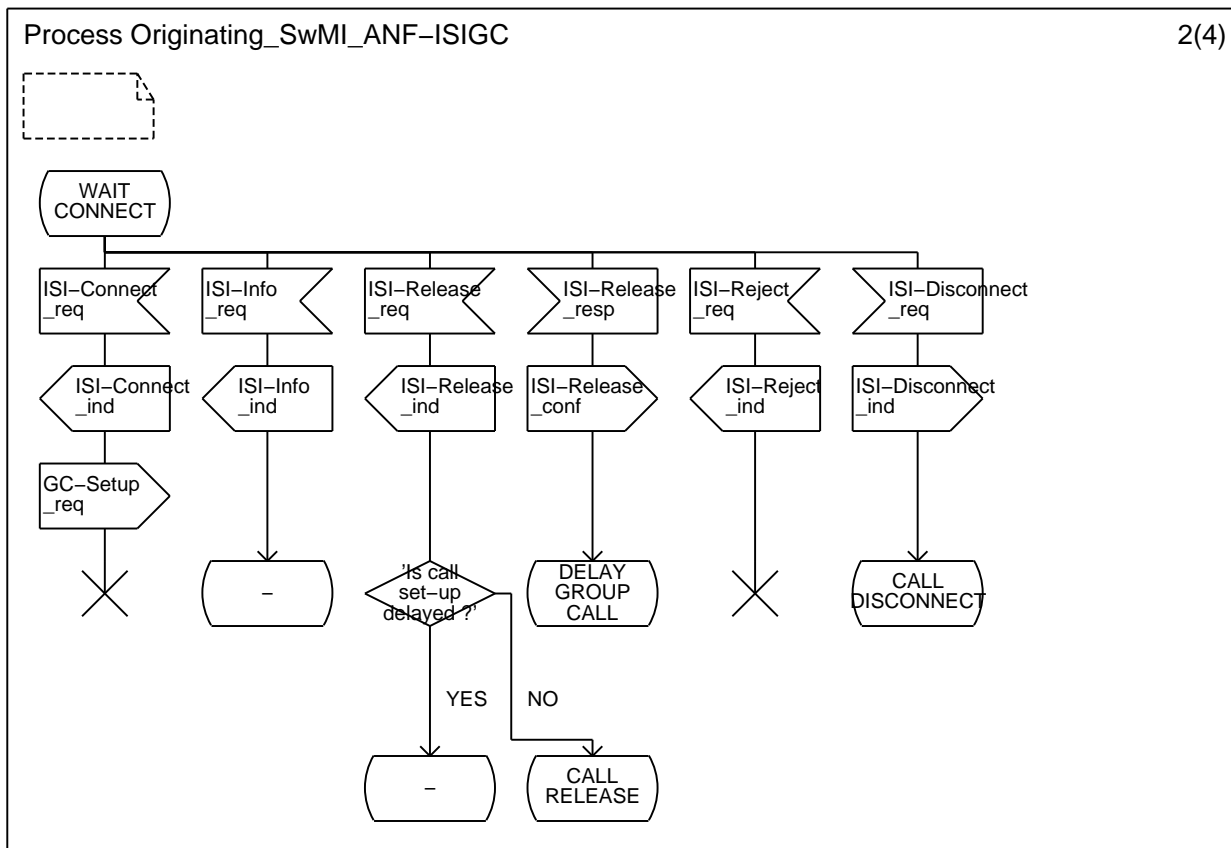


Figure A.2: SDL for originating SwMI ANF-ISIGC entity

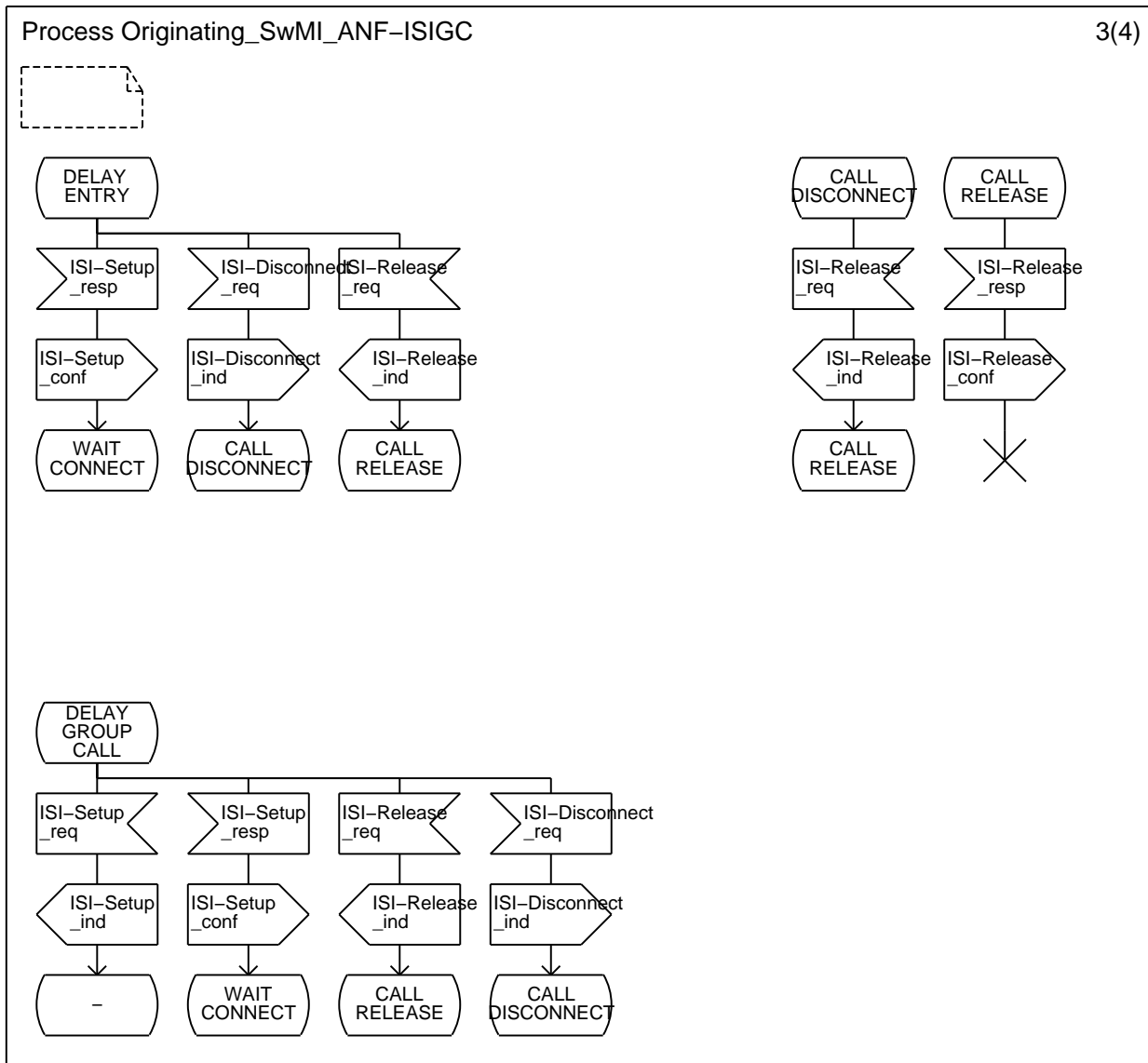


Figure A.3: SDL for originating SwMI ANF-ISIGC entity

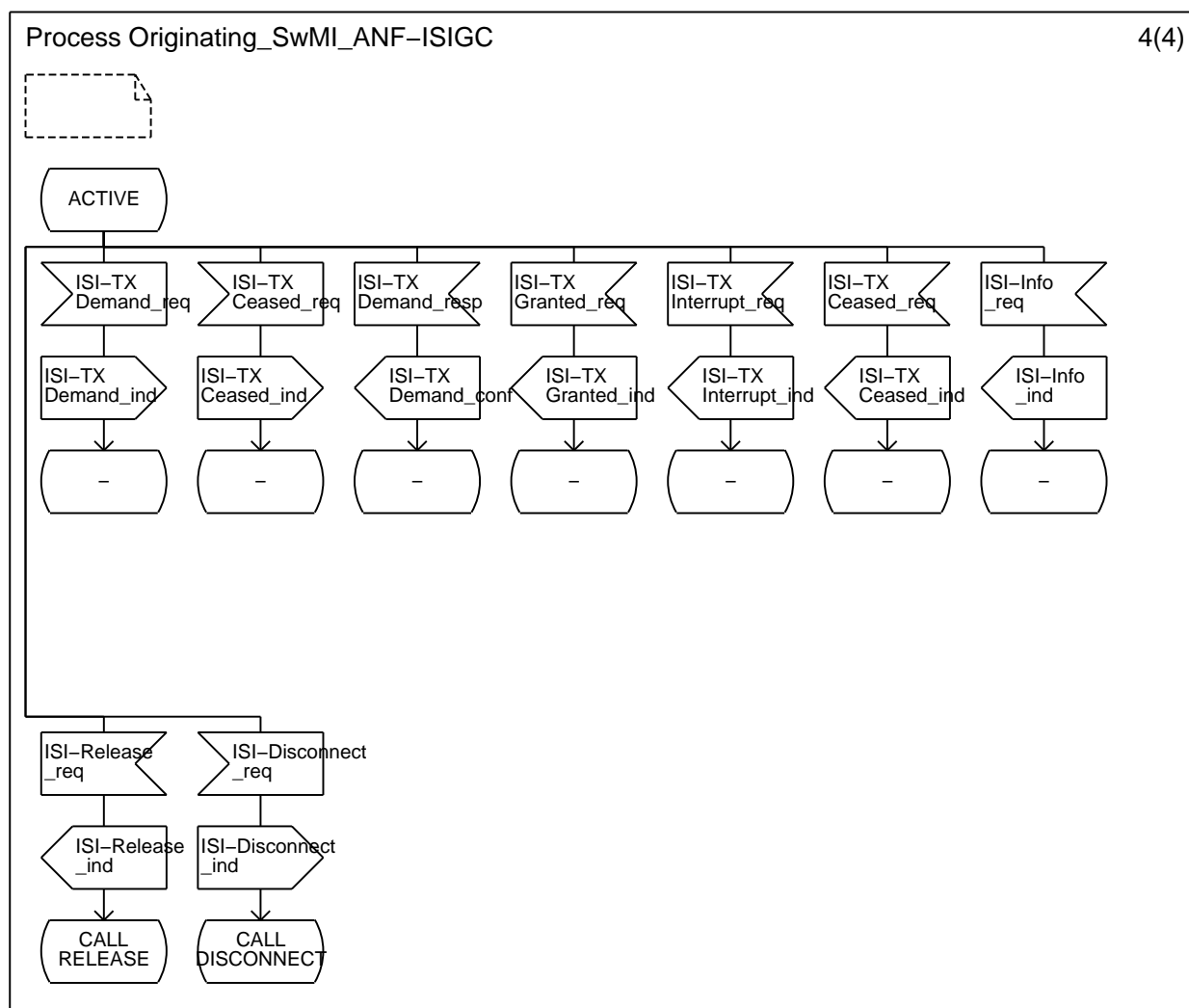


Figure A.4: SDL for originating SwMI ANF-ISIGC entity

## A.2 SDL representation of an ANF-ISIGC entity at FE2

Figures A.5 to A.8b show the behaviour of an ANF-ISIGC entity at the group home/controlling SwMI.

The following conventions are used:

- the input signals from the left represent primitives from the group home/controlling SwMI call control application;
- the output signals to the left represent primitives to the group home/controlling SwMI call control application;
- the input signals from the right represent primitives from the originating or participating SwMI ANF-ISIGC entity;
- the output signals to the right represent primitives to the originating or participating SwMI ANF-ISIGC entity.

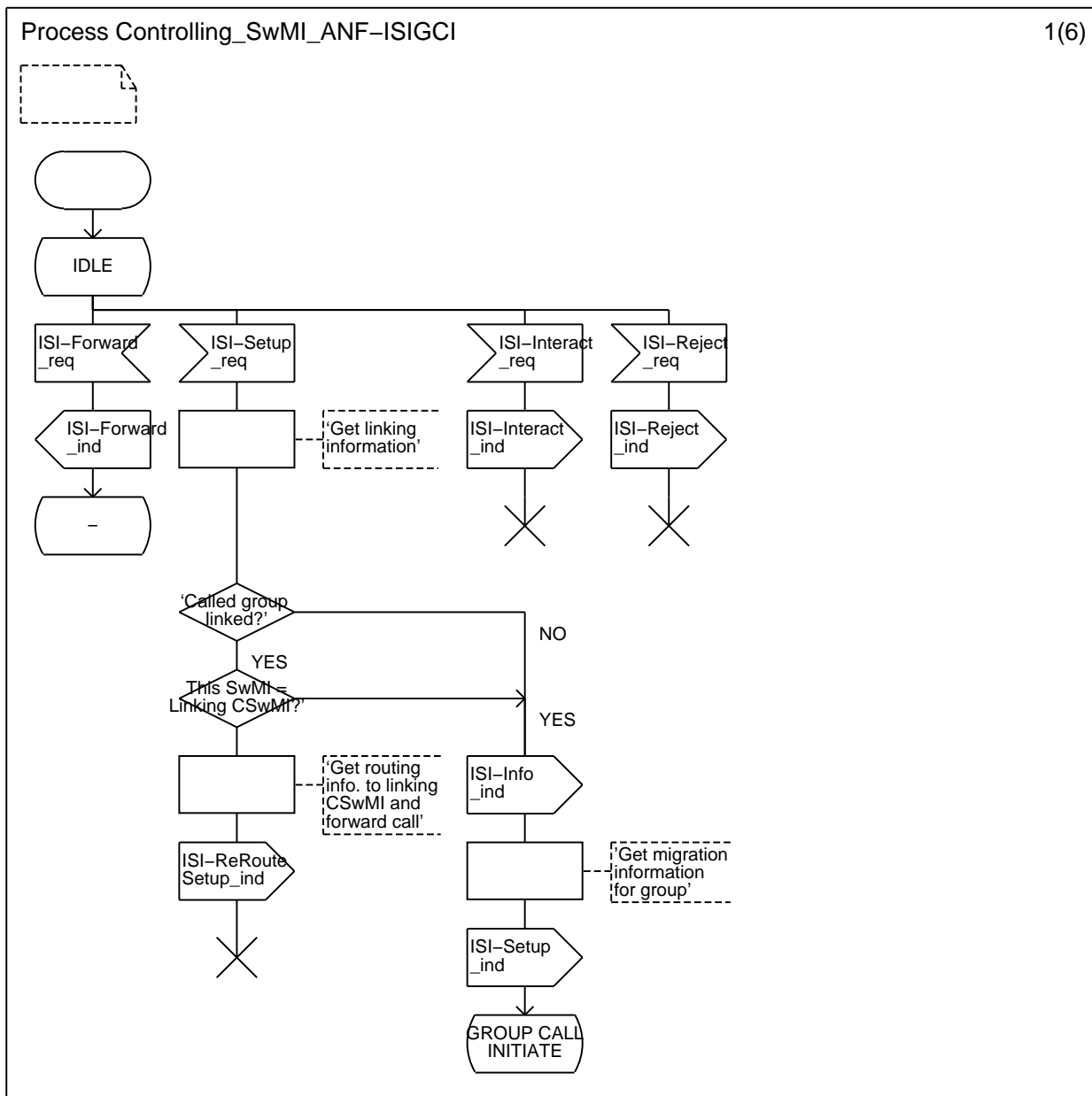


Figure A.5: SDL for group home/controlling SwMI ANF-ISIGC entity



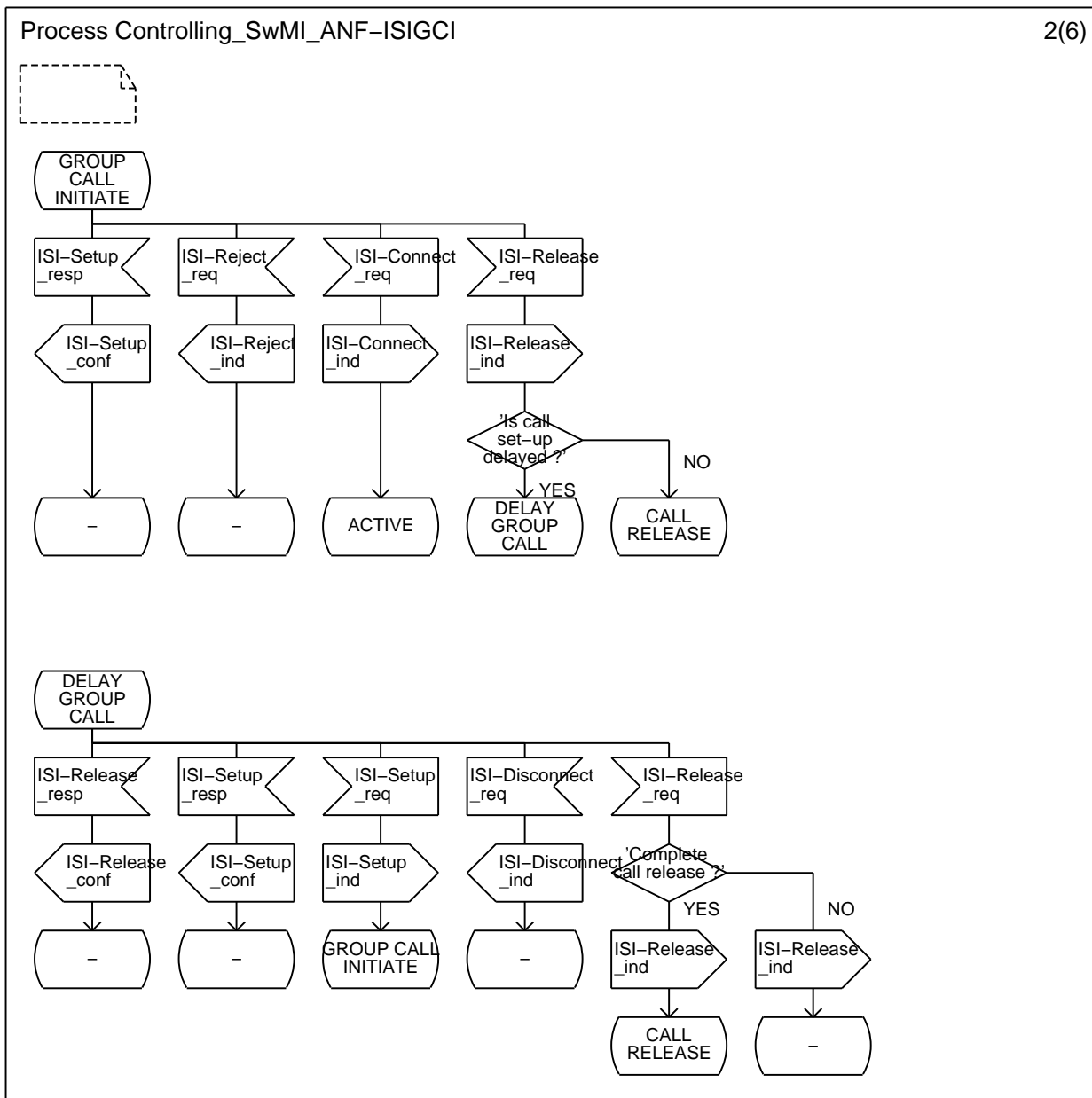


Figure A.6: SDL for group home/controlling SwMI ANF-ISIGC entity

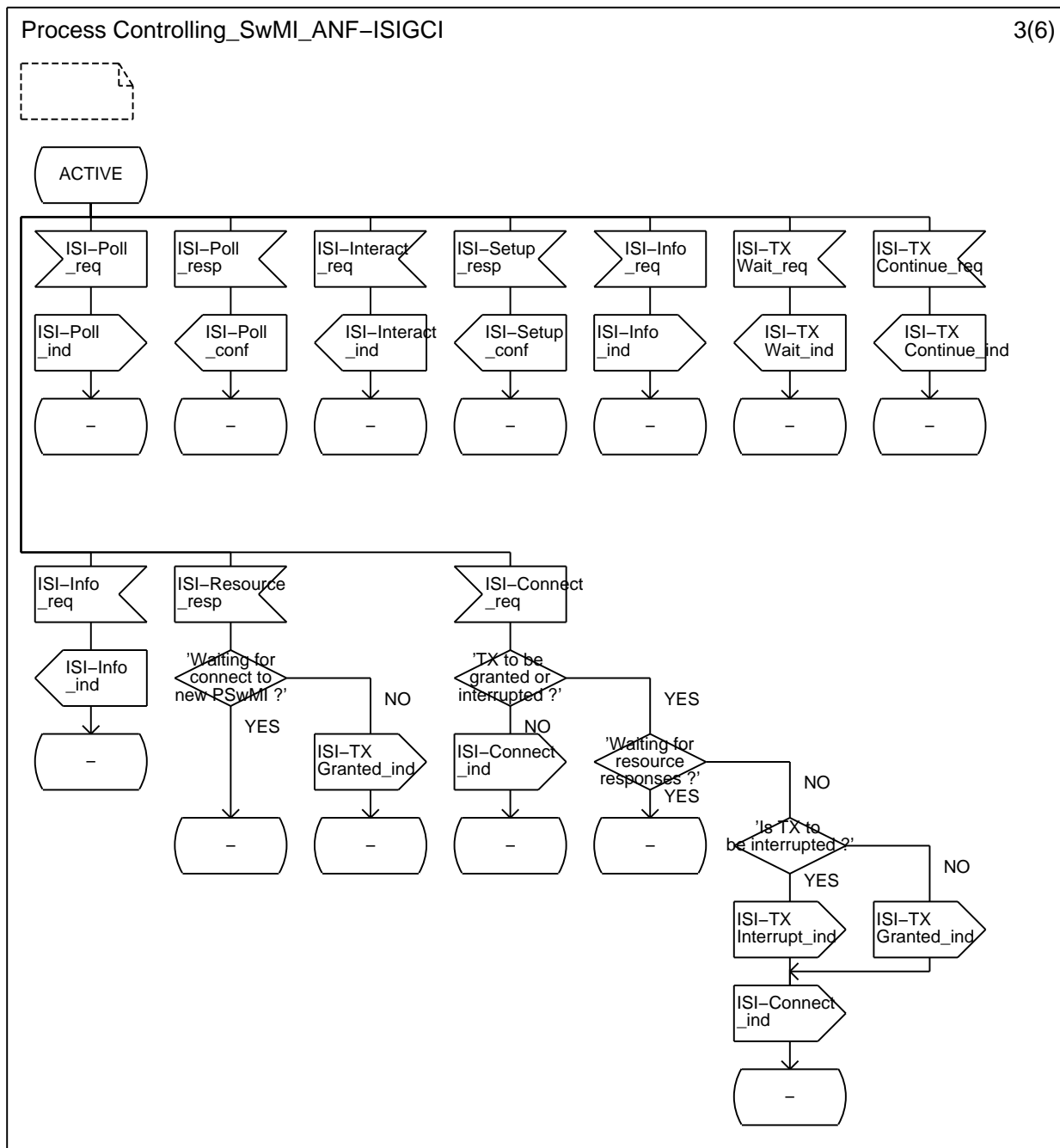


Figure A.7: SDL for group home/controlling SwMI ANF-ISIGC entity

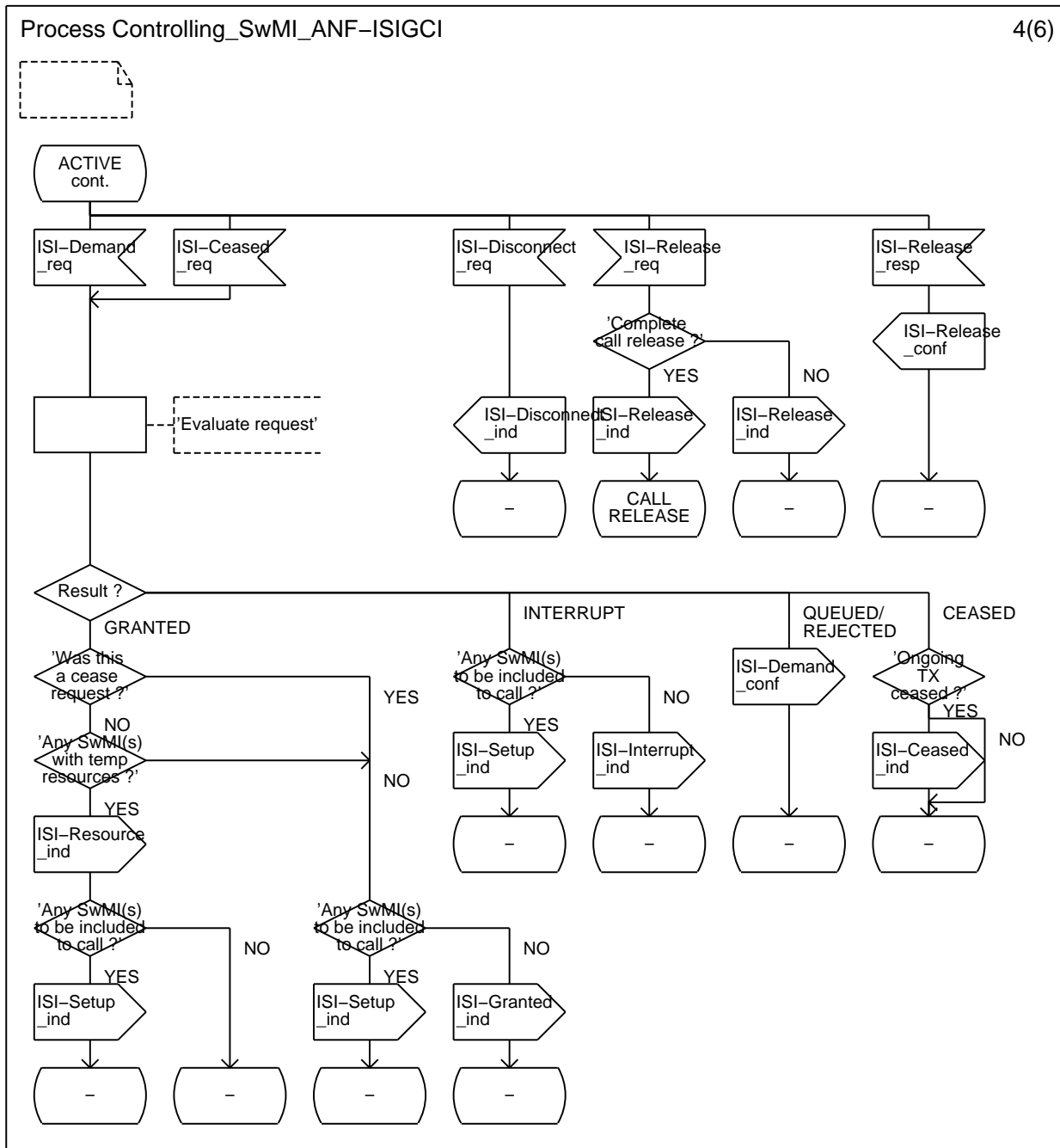


Figure A.8: SDL for group home/controlling SwMI ANF-ISIGC entity

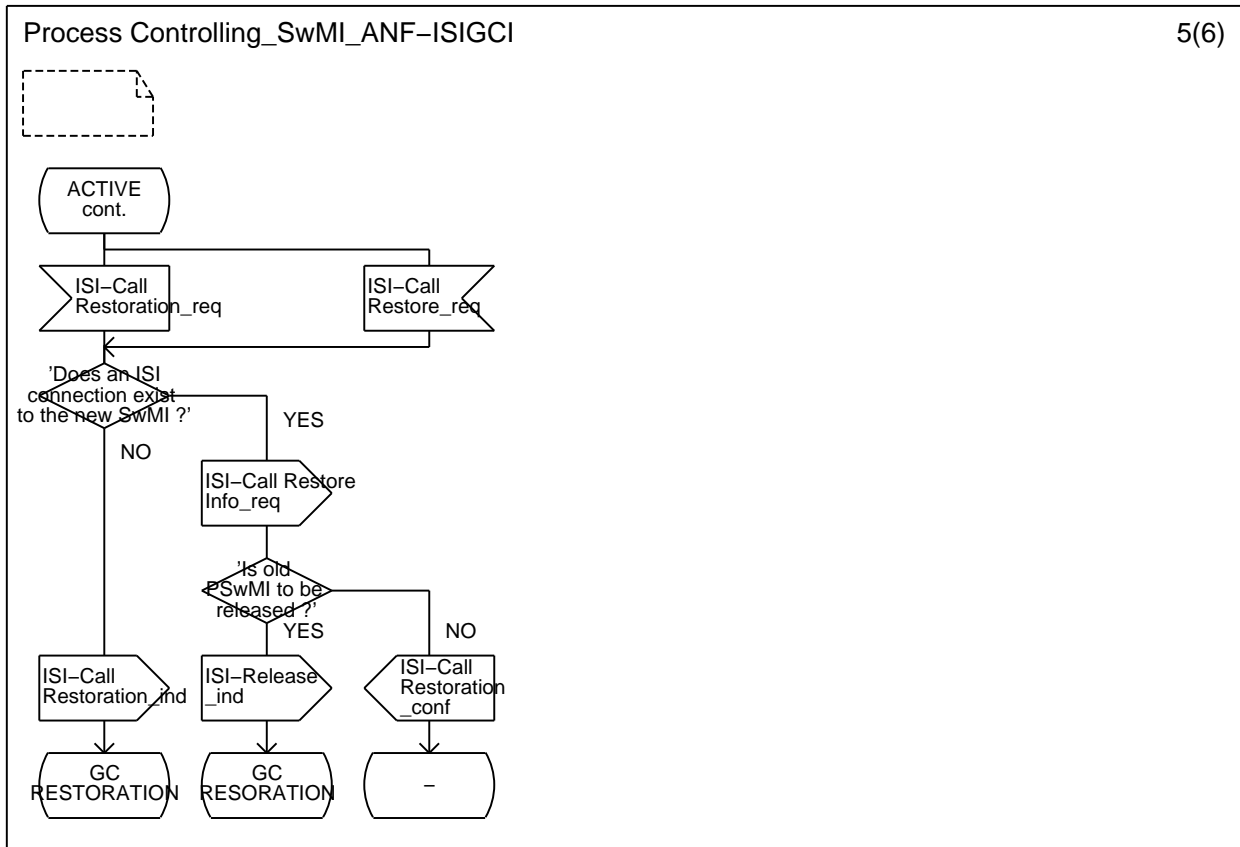


Figure A.8a

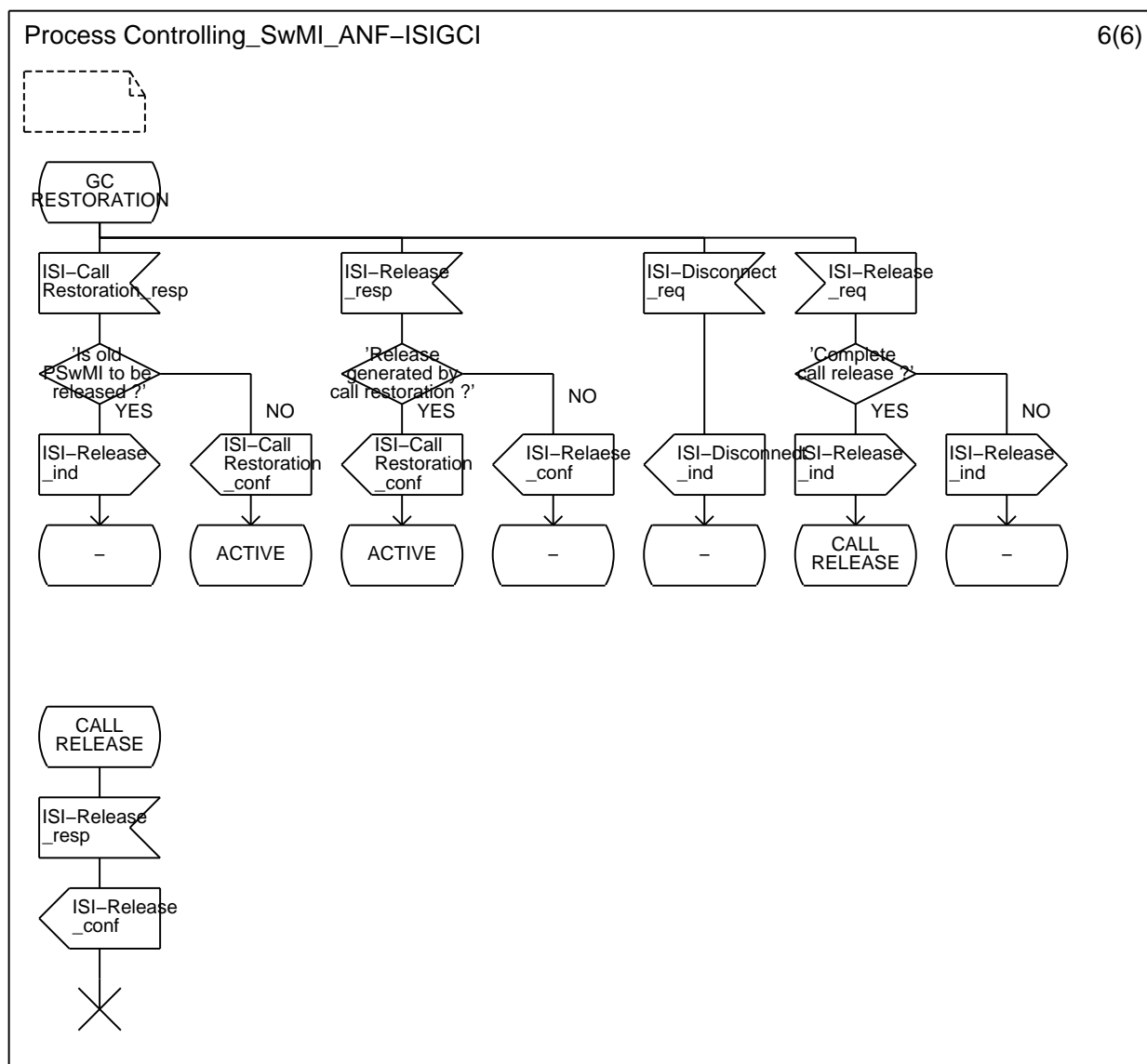


Figure A.8b

### A.3 SDL representation of an ANF-ISIGC entity at FE3

Figures A.9 to A.11 show the behaviour of an ANF-ISIGC entity at the participating SwMI.

The following conventions are used:

- the input signals from the left represent primitives from the participating SwMI call control application;
- the output signals to the left represent primitives to the participating SwMI call control application;
- the input signals from the right represent primitives from the controlling SwMI ANF-ISIGC entity;
- the output signals to the right represent primitives to the controlling SwMI ANF-ISIGC entity.

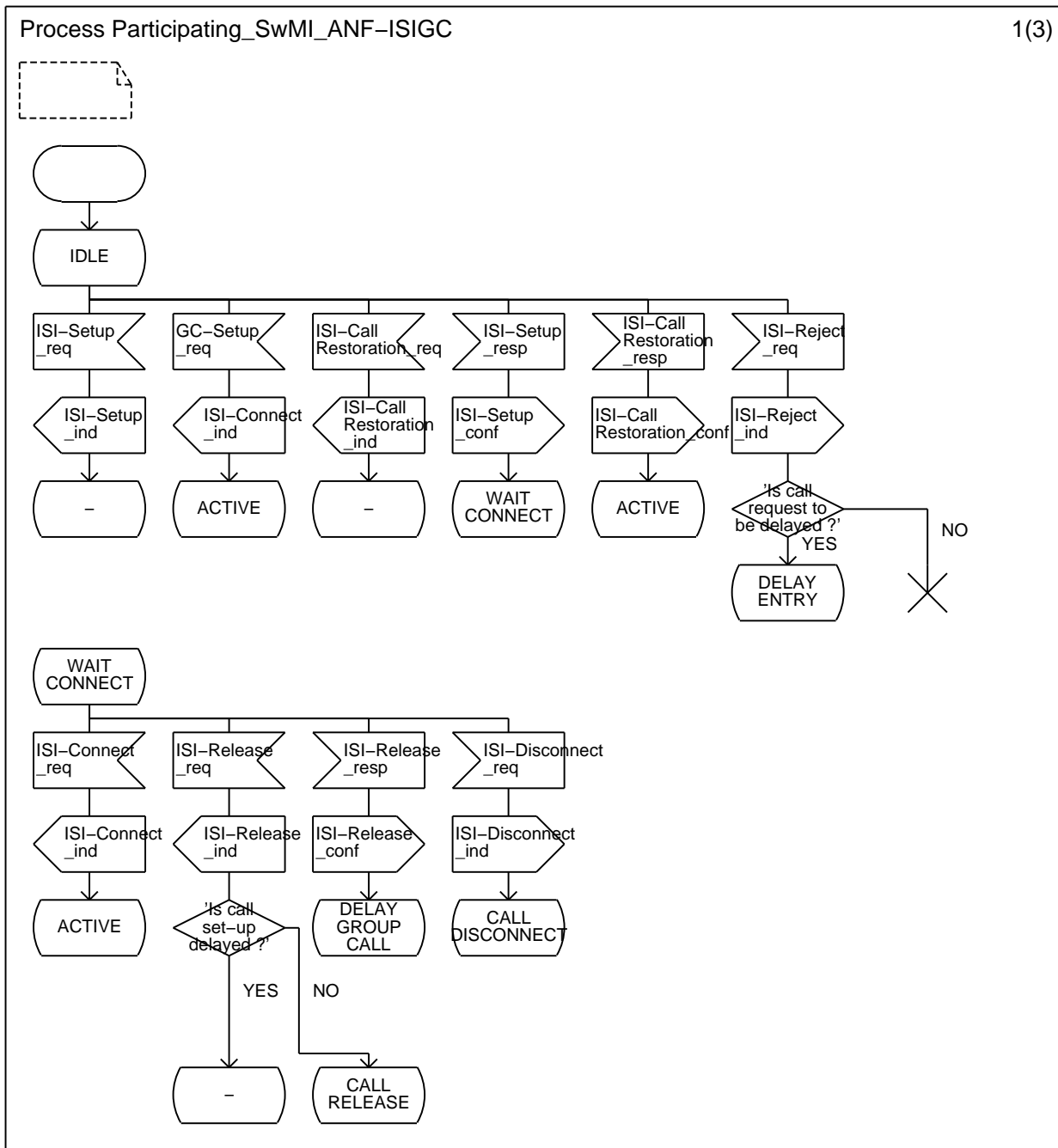


Figure A.9: SDL for participating SwMI ANF-ISIGC entity

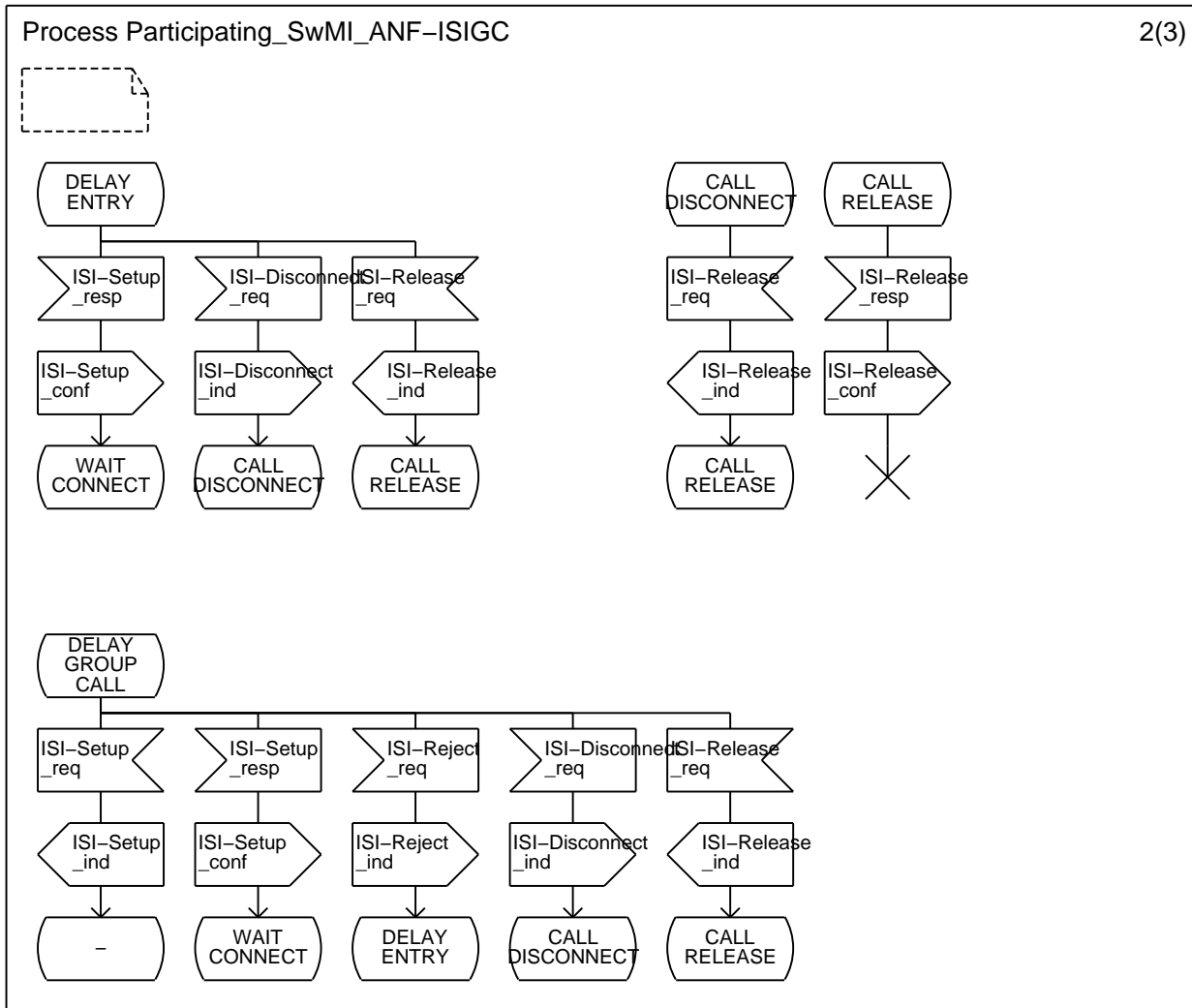


Figure A.10: SDL for participating SwMI ANF-ISIGC entity

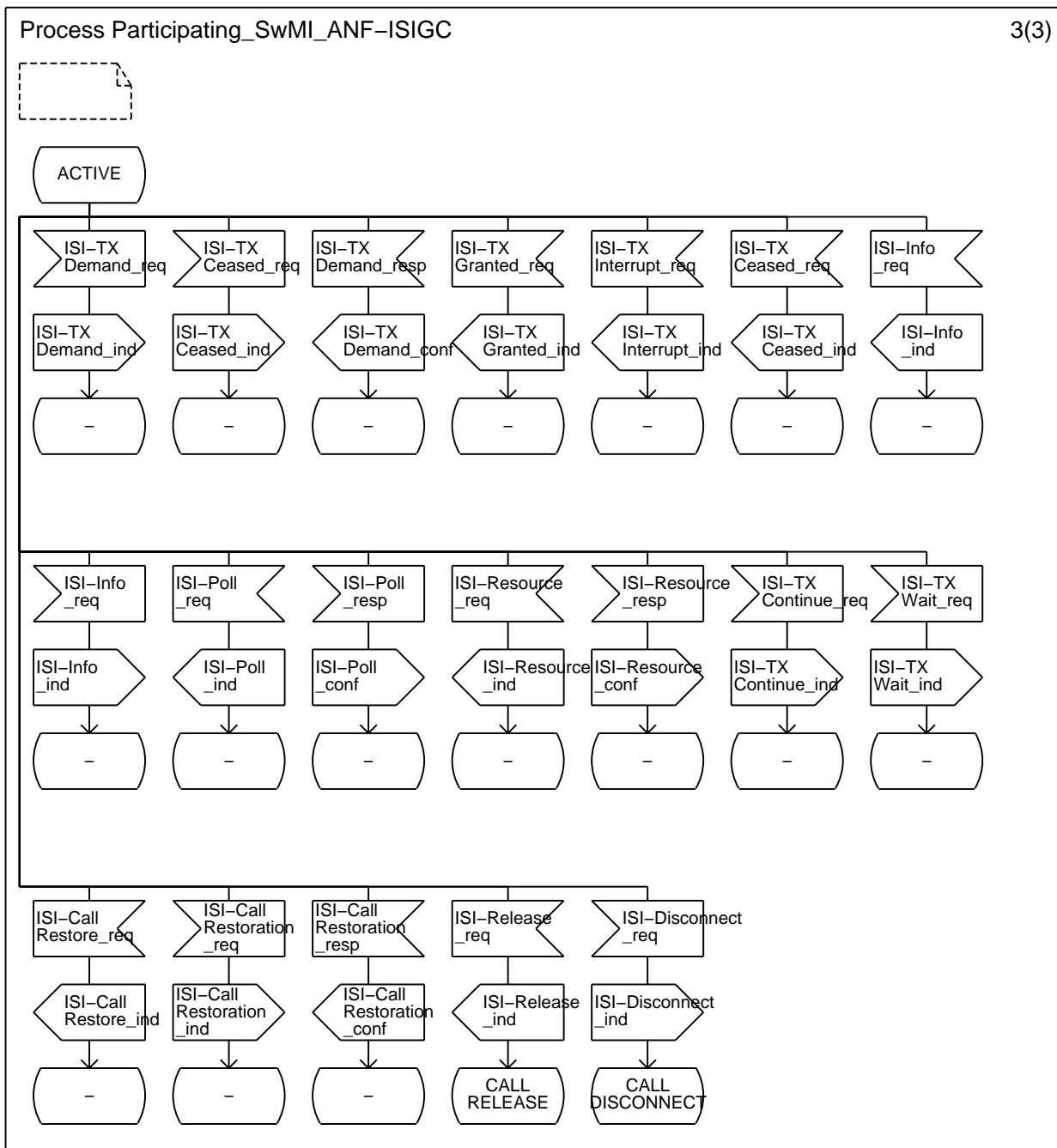


Figure A.11: SDL for participating SwMI ANF-ISIGC entity



---

## Annex B (normative): Stage 2 description of the interactions between ANF-ISIGC and SS-CAD when invoked for the called group

### B.1 Information flow diagrams

#### B.1.1 Group call set-up when SS-CAD is invoked for called group

In the case of incoming calls to a restricted group, the supplementary service CAD shall be invoked by the group home SwMI when a call request to the restricted group is received. If authorization is required by a dispatcher, three methods of call set-up may be made.

For the **case 1 scenario** direct call set-up shall be made between the calling user and the dispatcher. Indication sent to the calling user, that the call has been temporarily diverted, is optional. If the call is authorized by the dispatcher, indication of acceptance should be sent to the calling user and the dispatcher should be released. Figures B.1 to B.5 show a call set-up sequence using direct call set-up.

For the **case 2 scenario** a connection is made between the group home SwMI and the dispatcher. Indication sent to the calling user, that the call has been intercepted, is optional. If the call is authorized by the dispatcher, indication of acceptance should be sent to the calling user and the dispatcher should be released. Figures B.6 to B.8 show a call set-up sequence using call to dispatcher without call set-up to the calling user.

For the **case 3 scenario** call set-up shall only be made between the calling user and the dispatcher on-demand from the dispatcher. Indication sent to the calling user, that the call has been intercepted, is optional. If the dispatcher wishes to set-up a call to the calling user, call set-up will continue as for direct call set-up (see figures B.2 to B.5). If the call is authorized by the dispatcher, indication of acceptance should be sent to the calling user and the dispatcher should be released. Figures B.9 and B.10 show a call set-up sequence using on-demand call set-up to the calling user.

# MSC SS-CAD\_Direct\_call\_set-up

/\* Direct call set-up to dispatcher  
 Dispatcher has migrated from group SwMI  
 SS-CAD invoked for called group  
 Group HSwMI not collocated with OSwMI\*/

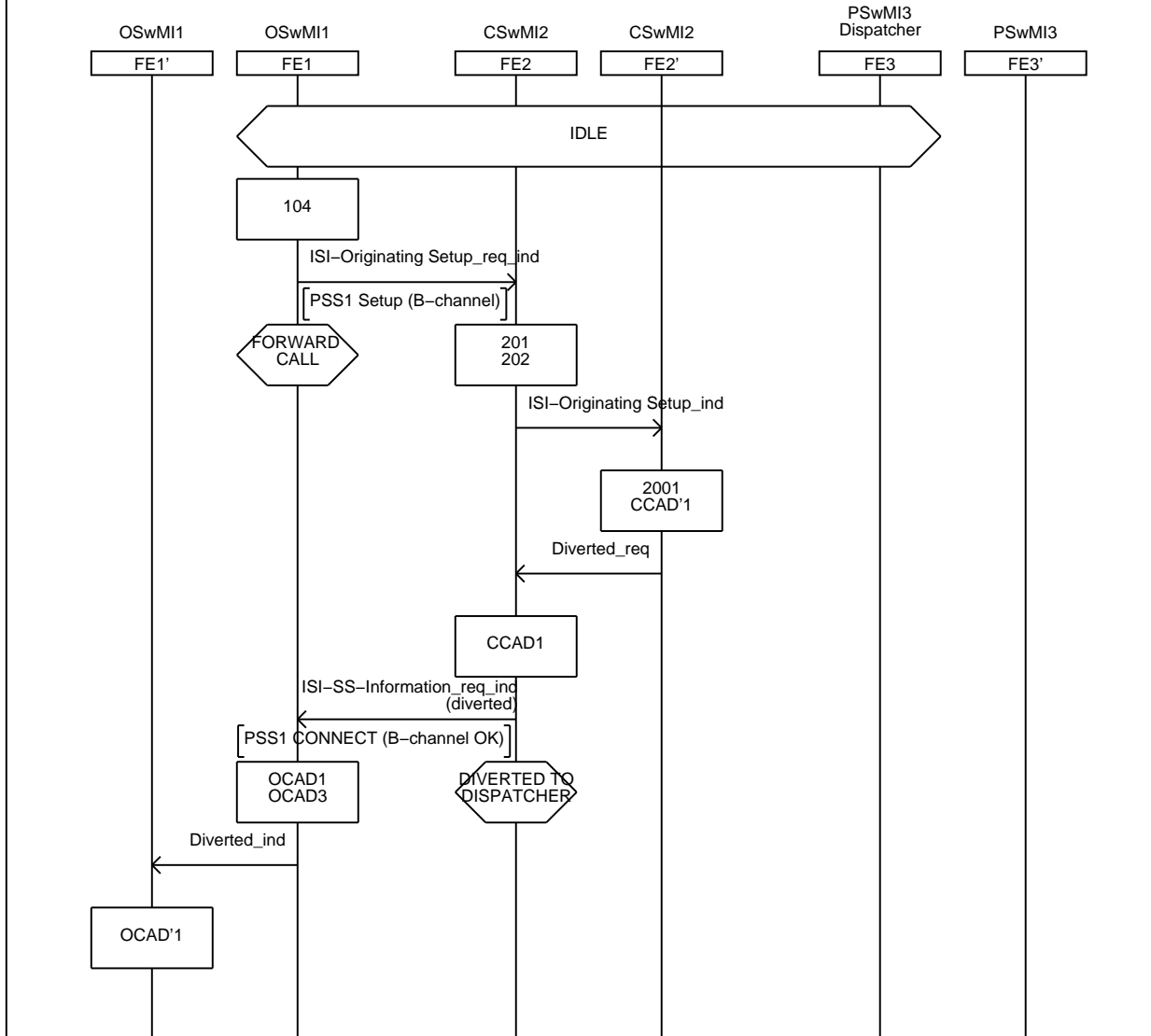


Figure B.1: Information flow sequence - Direct call set-up to dispatcher (sheet 1 of 5)

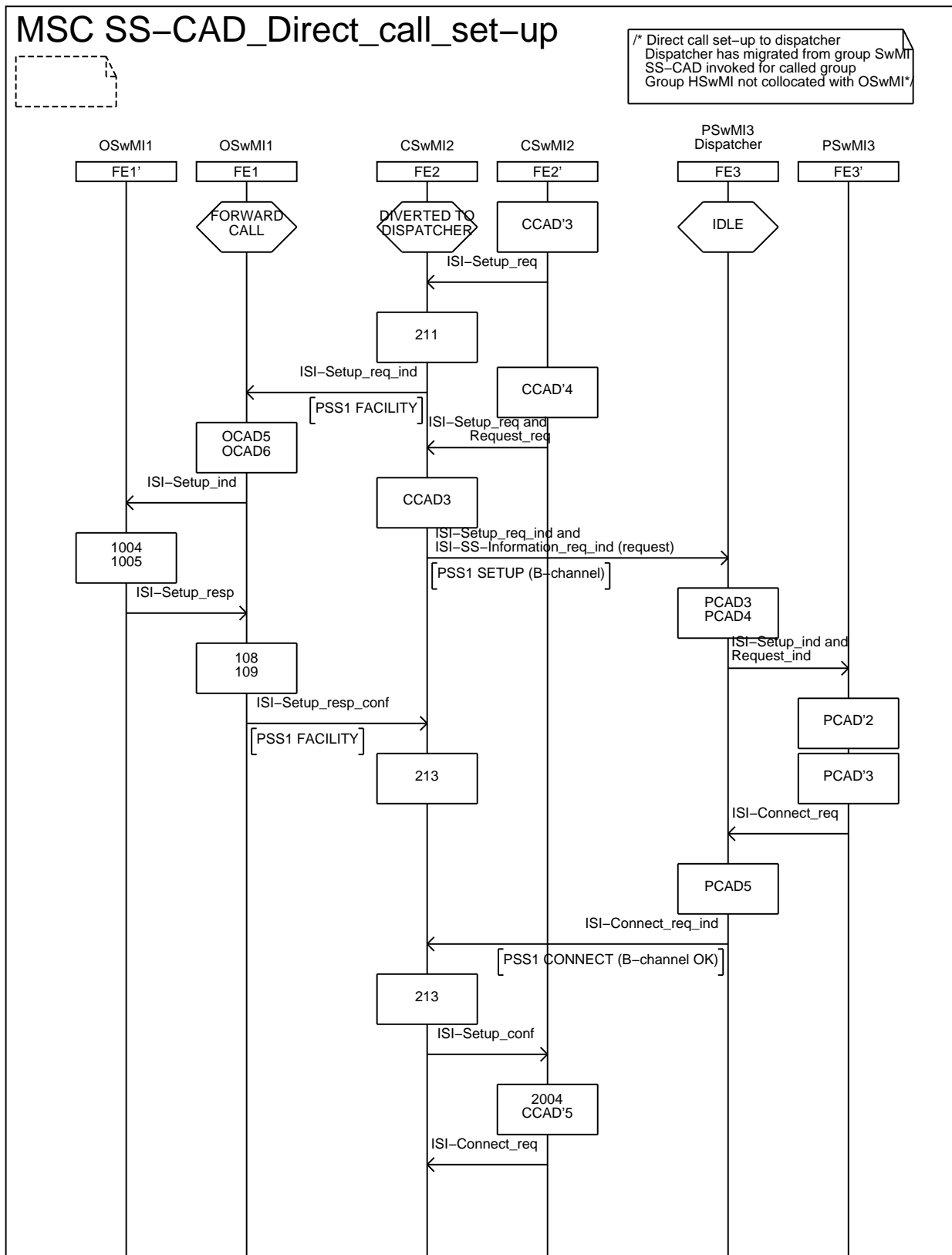


Figure B.2: Information flow sequence - Direct call set-up to dispatcher (sheet 2 of 5)

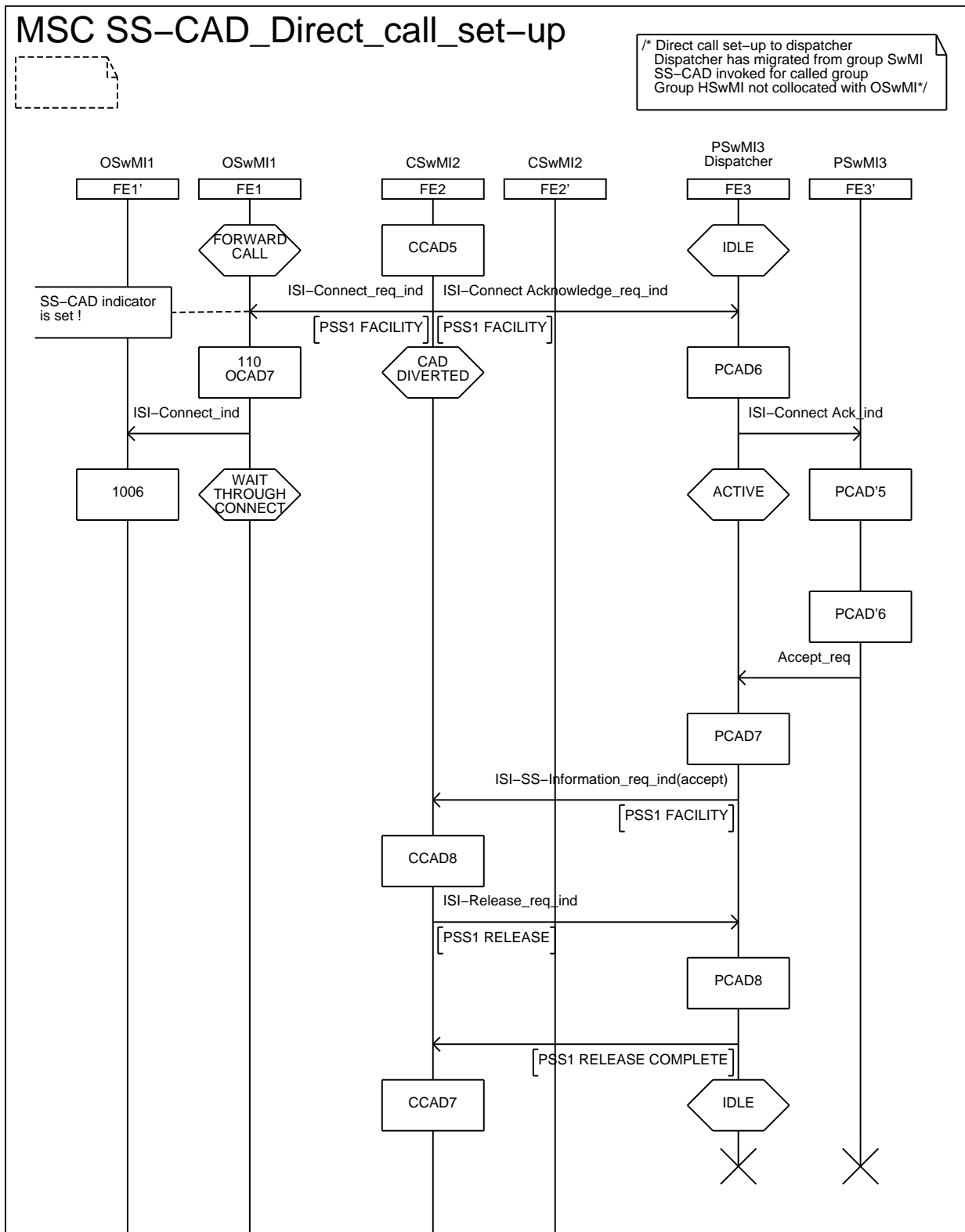


Figure B.3: Information flow sequence - Direct call set-up to dispatcher (sheet 3 of 5)

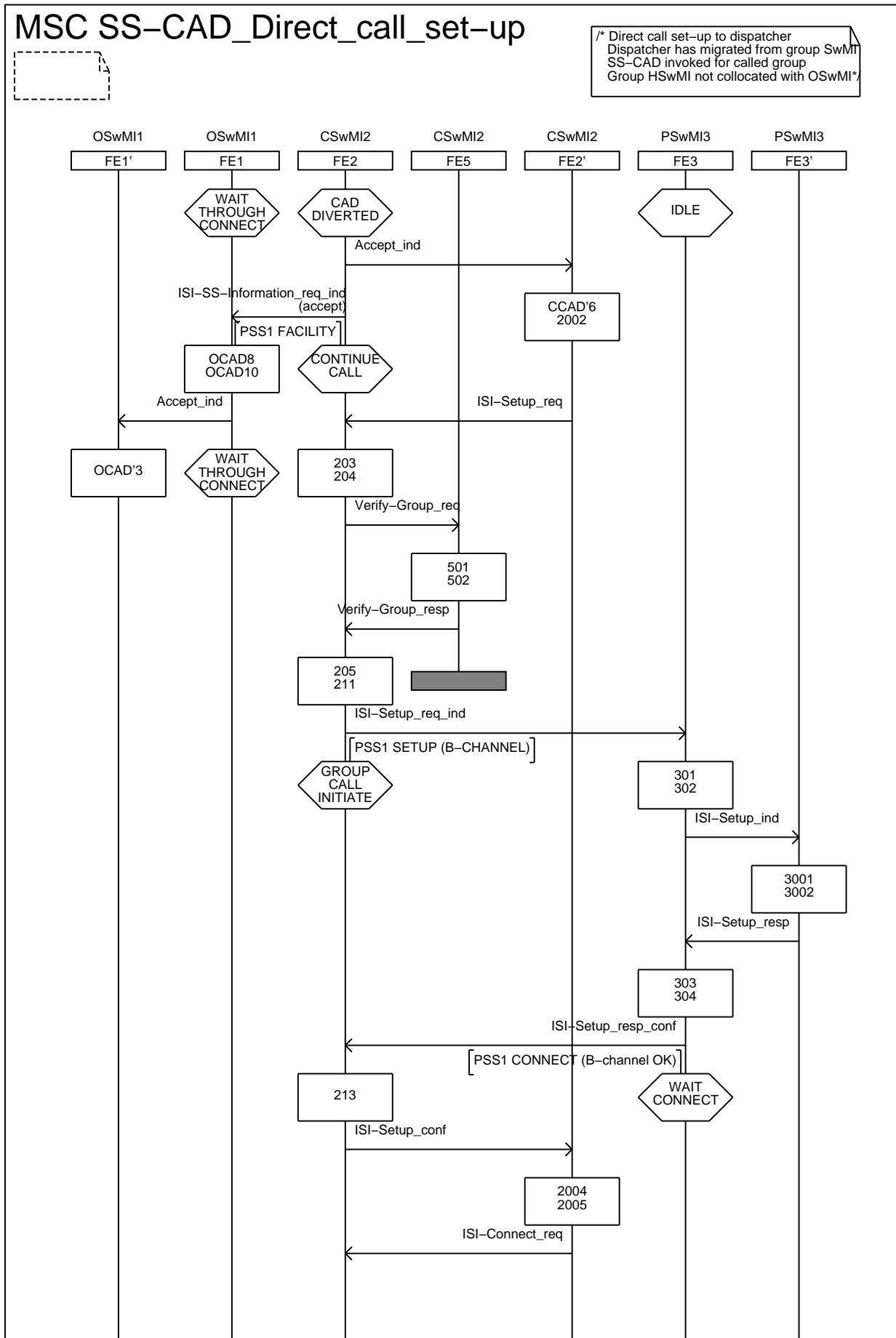


Figure B.4: Information flow sequence - Direct call set-up to dispatcher (sheet 4 of 5)

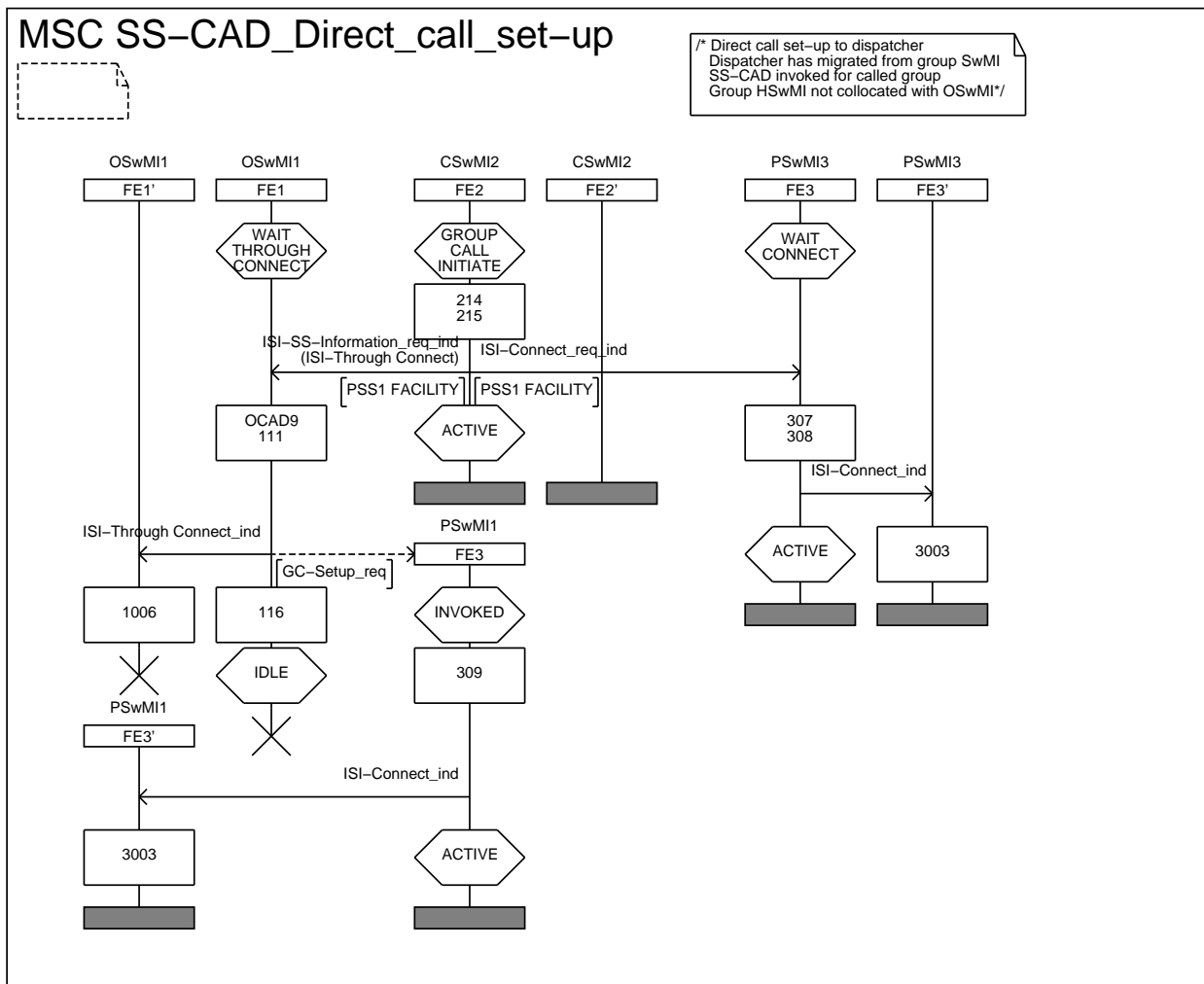
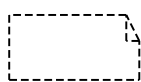


Figure B.5: Information flow sequence - Direct call set-up to dispatcher (sheet 5 of 5)

Upon reception of the group addressed ISI-SETUP ind. with the SS\_CAD indicator set, the originating SwMI shall evaluate if the group call can be performed and reserve resources for the group call. However, the group members shall not be connected until a ThroughConnect ind. is received from the controlling SwMI.

The resources reserved in the originating SwMI shall upon reception of the group ISI-SETUP ind. remain reserved until a ThroughConnect ind. or ISI-RELEASE ind. is received. At this point, the group call is either connected to the members of the group call in the originating SwMI using the reserved resources or the resources are released because the call could not be set-up.

# MSC SS-CAD\_Call\_without\_call\_set-up



/\* Call to dispatcher without call set-up  
 Dispatcher has migrated from group SwMI  
 SS-CAD invoked for called group  
 Group HSwMI not collocated with OSwMI\*/

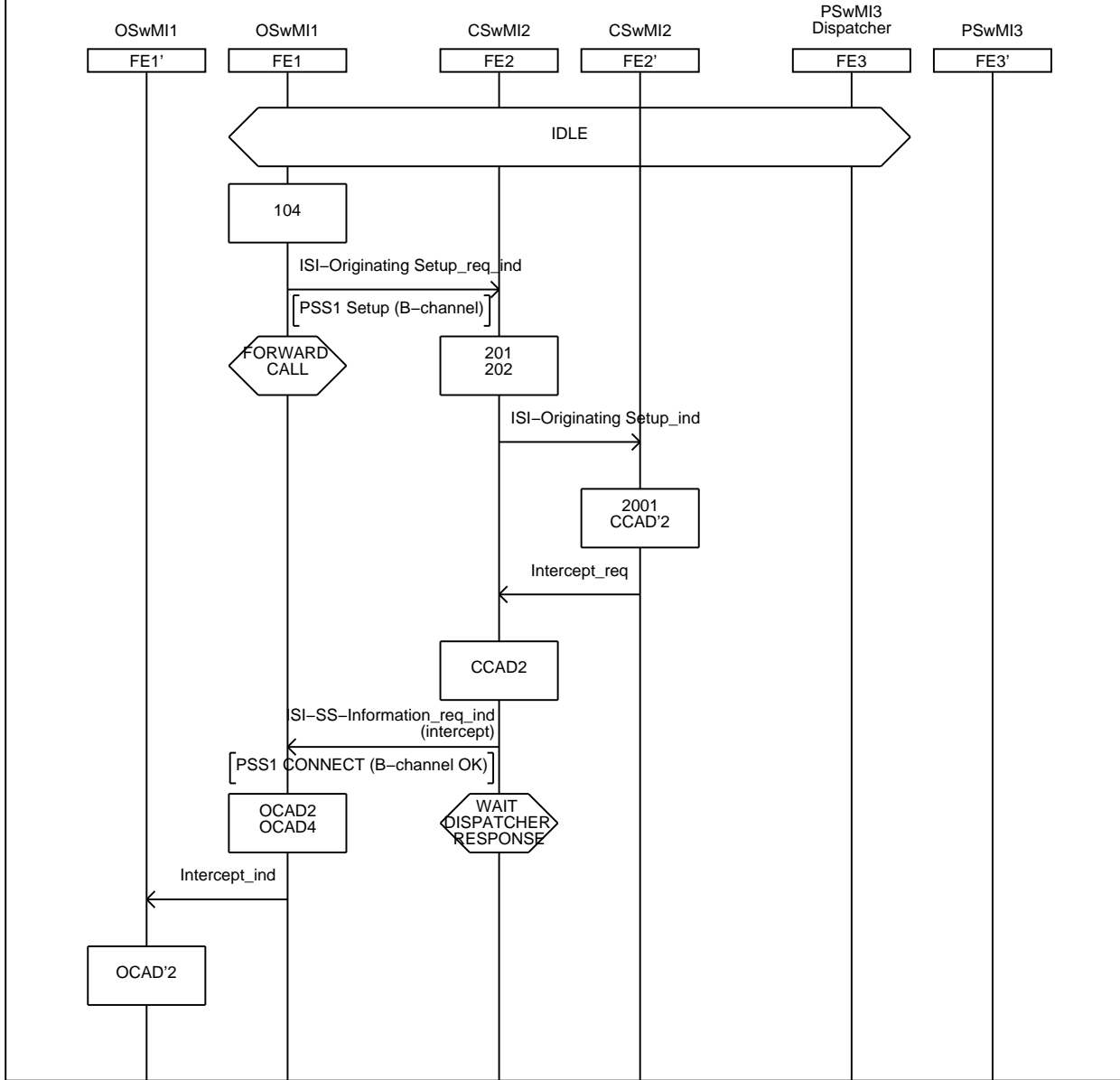


Figure B.6: Information flow sequence - Call to dispatcher without call set-up (sheet 1 of 3)

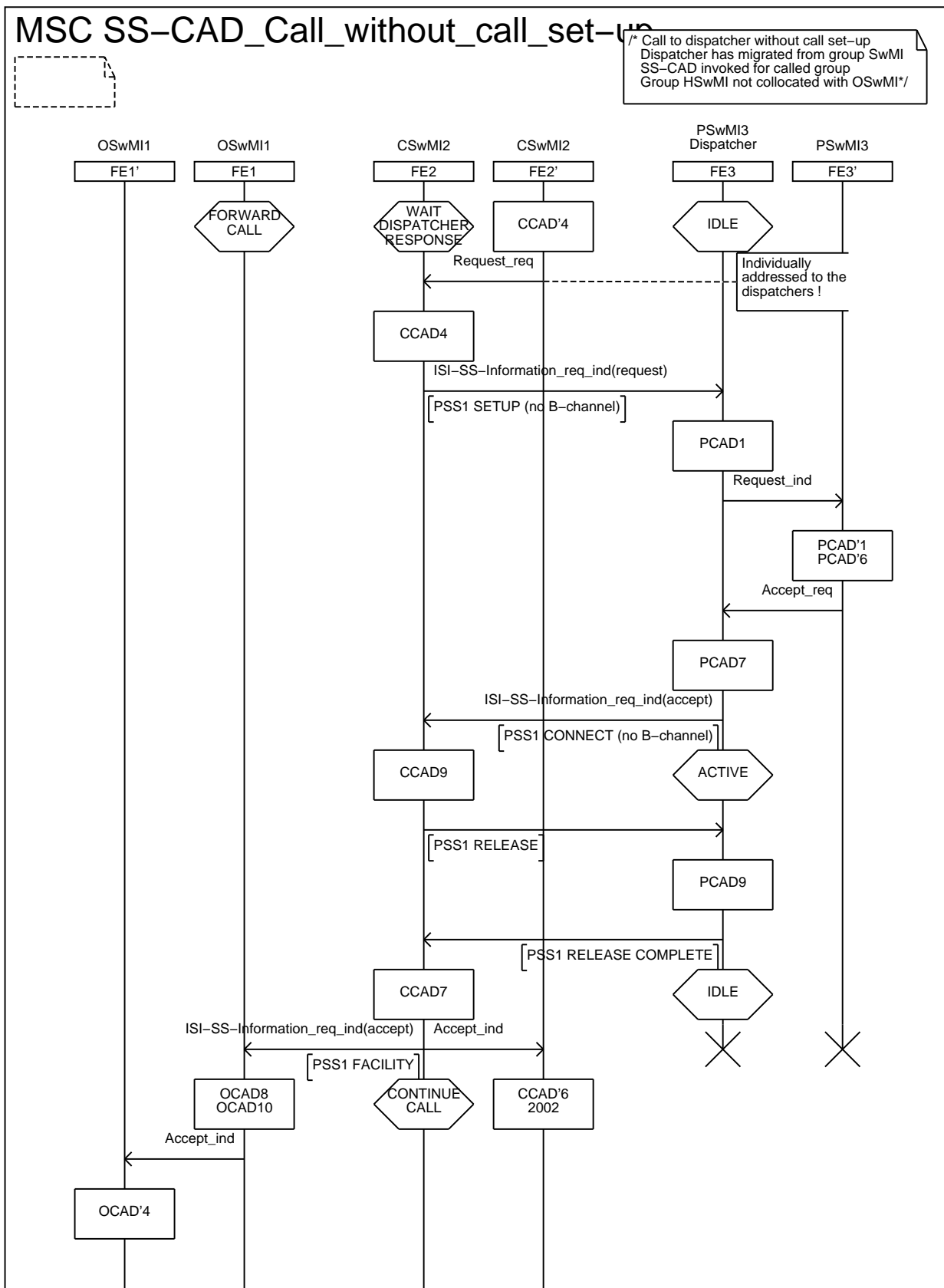
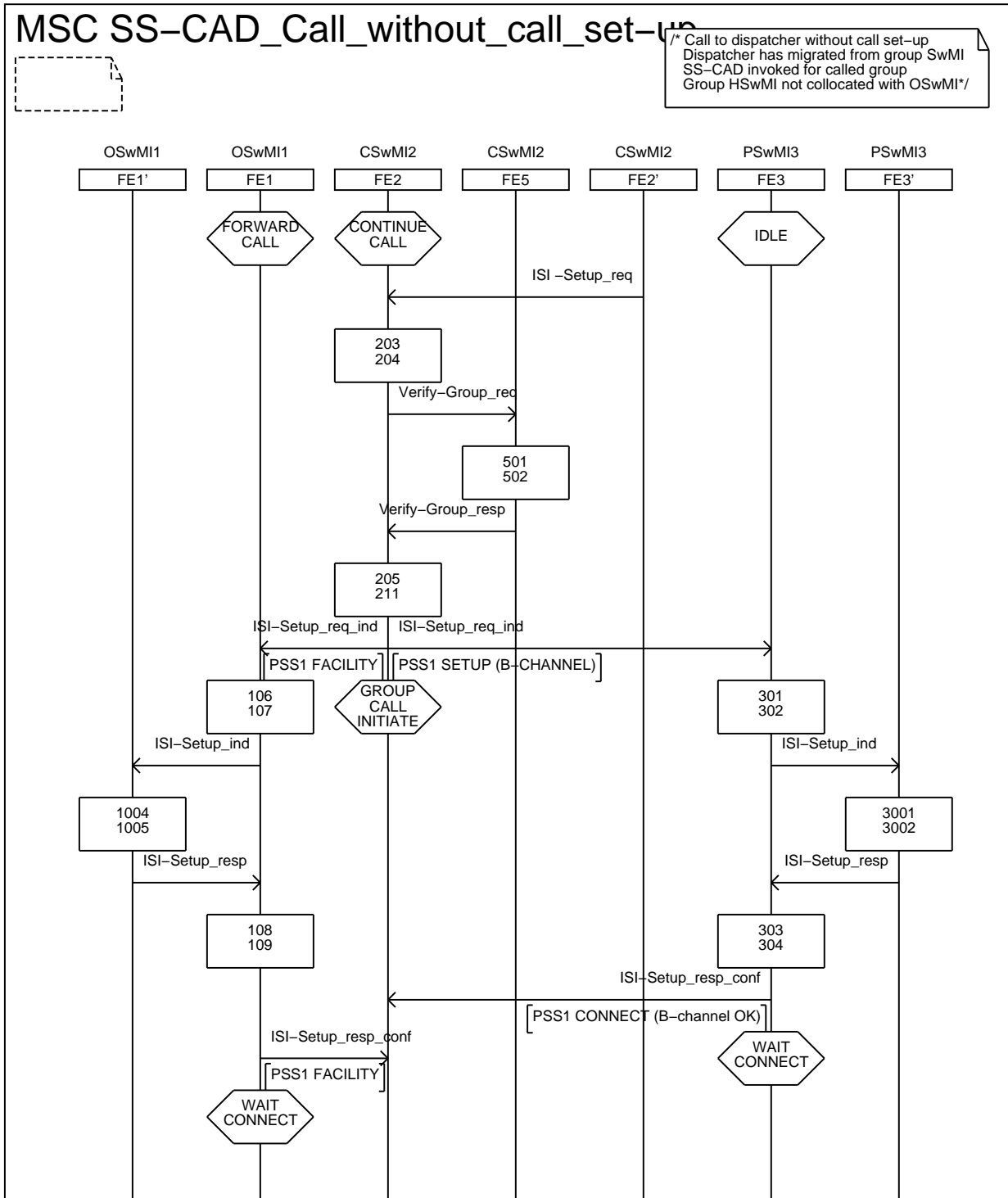


Figure B.7: Information flow sequence - Call to dispatcher without call set-up (sheet 2 of 3)





NOTE: See figures 21 to 22 for the completion of call set-up.

**Figure B.8: Information flow sequence - Call to dispatcher without call set-up (sheet 3 of 3)**

# MSC SS-CAD\_On-Demand\_call\_set-up

/\* On-Demand call set-up to the dispatcher  
 Dispatcher has migrated from group SwMI  
 SS-CAD invoked for called group  
 Group HSwMI not collocated with OSwMI\*/

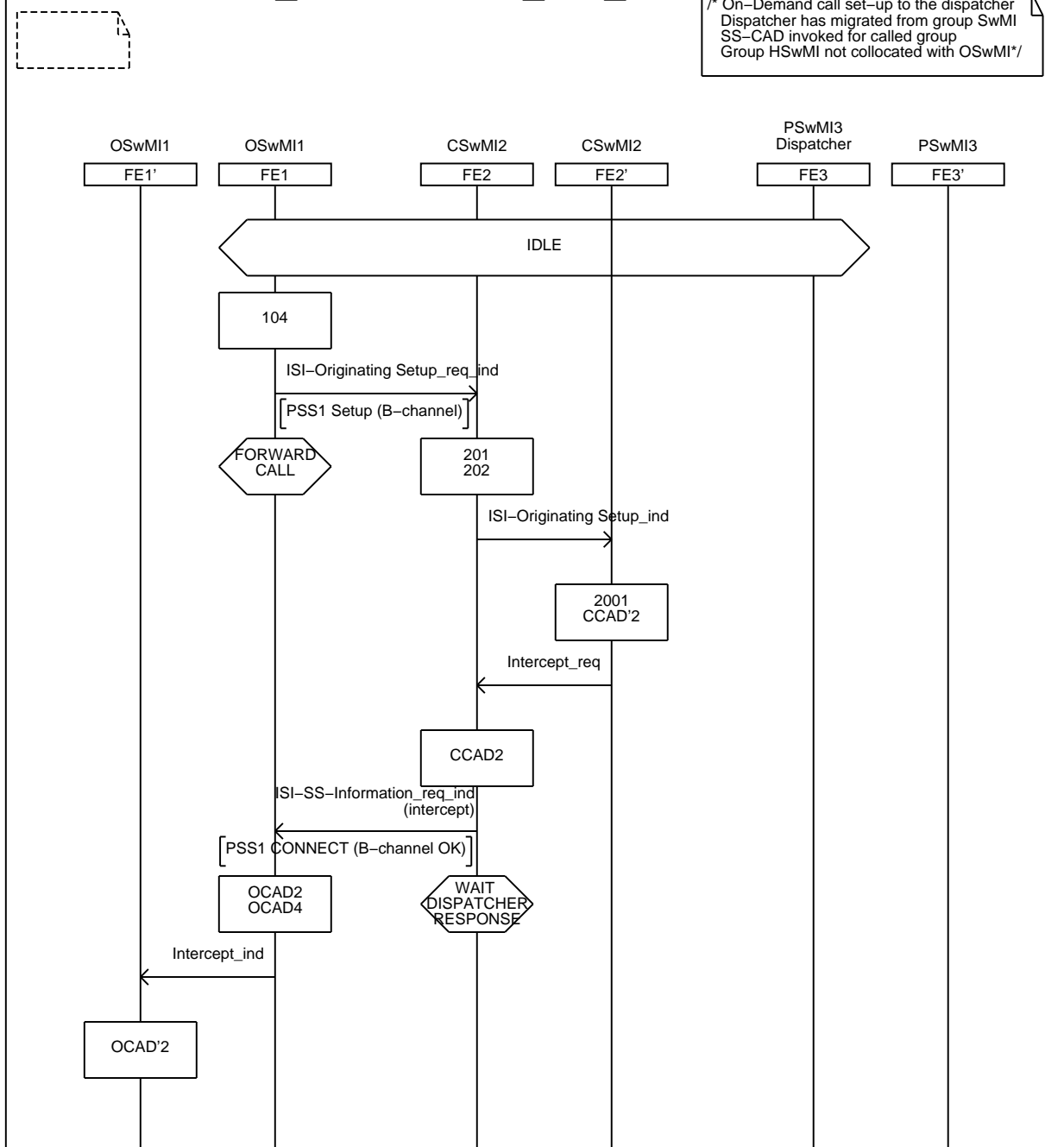
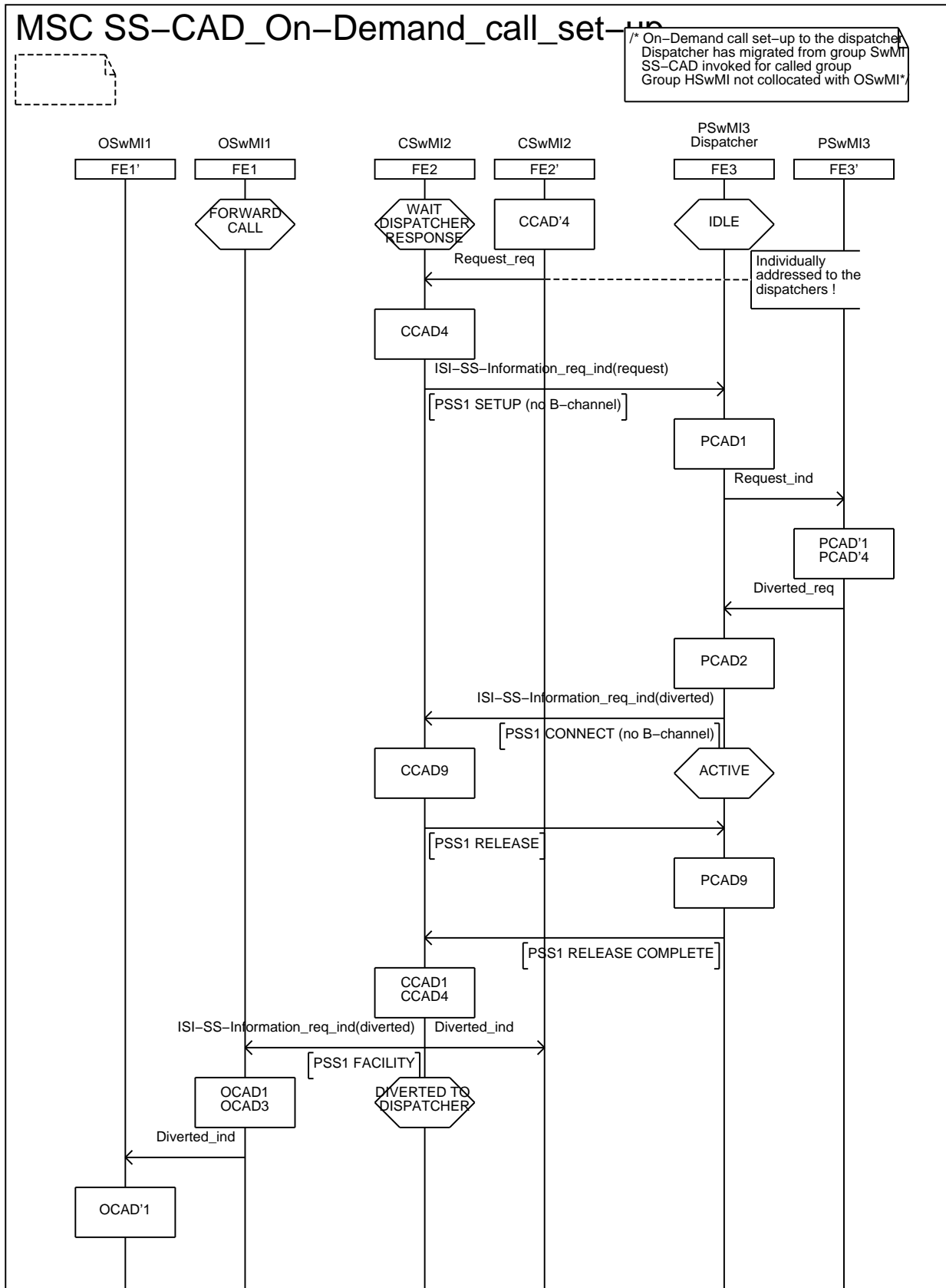


Figure B.9: Information flow sequence - On-demand call set-up (sheet 1 of 2)



NOTE: See figure CAD2 to CAD5 for the call set-up sequence.

**Figure B.10: Information flow sequence - On-demand call set-up (sheet 2 of 2)**

## B.2 Definition of information flows

The information flow PDUs have been defined for SS\_CAD when additional information needs to be added to the PDU. For a complete list of SS-CAD PDUs see EN 300 392-11-6 [8].

### B.2.1 ISI\_THROUGH CONNECT

ISI\_THROUGH CONNECT is an unconfirmed information flow:

- across relationship rc from FE2 to FE1; and
- across relationship ra from FE1 to FE1'.

ISI\_THROUGH CONNECT request/indication information flow shall be sent to the originating SwMI to inform it to through connect group members located in the originating SwMI.

Table B.1 lists the service elements within the ISI\_THROUGH CONNECT information flow.

**Table B.1: Content of ISI\_THROUGH CONNECT**

Service element	Request
Set-up type (full, partial)	M
Basic service information	C (see note 1)
Call priority (emergency, priority 1-14)	C (see note 1)
Call ownership	C (see note 1)
Call amalgamation	M
Transmission grant	M
Transmission request permission	M
Calling user identity	M (see note 2)
Call diverted to a dispatcher	M
Notification indicator	O
Proprietary	O
NOTE 1: Conditional on the value of call amalgamation. If the information element "call amalgamation" is not set, then the value of the information element shall be equal to the value received in the ISI-SETUP request primitive.	
NOTE 2: In the case of call amalgamation, only one of the original calling users shall become calling user for the group call. This information element shall contain this user's identity.	

## B.3 Functional Entity Actions (FEAs)

Only the SS-CAD specific actions are stated below. For the complete list of basic call functional entity actions see clause 5.3.

### B.3.1 Functional entity actions of FE1

- OCAD1 SS-CAD has been invoked for the called group. The group call request has been diverted.
- OCAD2 SS-CAD has been invoked for the called group. The group call request has been intercepted.
- OCAD3 Direct call set-up will be made to the dispatcher.
- OCAD4 Call set-up will not be made to the dispatcher or on-demand call set-up will be made with the dispatcher.
- OCAD5 Receive an individual addressed ISI\_SETUP req.ind.
- OCAD6 Forward the set-up request to FE1'.

- OCAD7 Inform FE1' to connect the calling user using the reserved resources.
- OCAD8 The dispatcher has accepted the call. Call set-up to the called group will continue.
- OCAD9 The call is now to be through connected.
- OCAD10 Inform FE1' of the accepted call.

### B.3.2 Functional entity actions of FE1'

- OCAD'1 The call has been diverted. Wait for a call set-up request to the dispatcher.
- OCAD'2 The call has been intercepted. Wait for acceptance from the dispatcher.
- OCAD'3 Wait for ISI\_THROUGH CONNECT req. to the called group.
- OCAD'4 Wait for normal group call set-up.

### B.3.3 Functional entity actions of FE2

- CCAD1 Send an ISI\_DIVERTED req.ind. to the FE1.
- CCAD2 Send an ISI\_INTERCEPT req.ind. PDU in the PSS1 CONNECT message.
- CCAD3 Set-up the call to the dispatcher as an individual call and indicate that SS-CAD has been invoked (SS PDU REQUEST).
- CCAD4 Request the dispatcher to authorize the incoming group call.
- CCAD5 Send an ISI\_CONNECT to FE1 to indicate that the calling user is to be connected and an ISI\_CONNECT ACKNOWLEDGE to FE3 to indicate that the dispatcher is to be through connected.
- CCAD6 The call is to be diverted to the dispatcher (On-demand call set-up by dispatcher).
- CCAD7 The call has been accepted. Inform FE1 and FE2.
- CCAD8 Release the call to the dispatcher.
- CCAD9 Release the PISN connection to the dispatcher's SwMI.

### B.3.4 Functional entity actions of FE2'

- CCAD'1 The supplementary service SS-CAD has been invoked on the called group number. Direct call set-up will be made to the dispatcher. Inform the originating SwMI that the call has been diverted.
- CCAD'2 The supplementary service SS-CAD has been invoked on the called group. A call will not be set-up with the dispatcher. However, the dispatcher can choose to set-up a call with the calling user on demand.
- CCAD'3 Perform a direct set-up between the originating SwMI, FE1, and the participating SwMI were the dispatcher is located.
- CCAD'4 The call is to be authorized by a dispatcher. Send the SS PDU REQUEST to the SwMI where the dispatcher is located to indicate that the call has been intercepted.
- CCAD'5 Send an ISI\_CONNECT req. to FE2 requesting that the diverted call be through connected.
- CCAD'6 The group call is accepted. Group call set-up can continue.

### B.3.5 Functional entity actions of FE3

- PCAD1 Send a request to a dispatcher to authorize the incoming group call.
- PCAD2 Inform FE2 that the call shall be diverted to the dispatcher.
- PCAD3 Receive an individual addressed ISI\_SETUP req.ind. to a dispatcher.
- PCAD4 Forward the request to FE3'.
- PCAD5 Forward the connect to FE2.
- PCAD6 Inform the dispatcher to through connect.
- PCAD7 Inform FE2 of the dispatcher acceptance.
- PCAD8 Release the dispatcher.
- PCAD9 Confirm that the PISN connection has been released.

### B.3.6 Functional entity actions of FE3'

- PCAD'1 Inform the dispatcher to evaluate the group call.
- PCAD'2 Evaluate if the necessary resources are available and that the migrated dispatcher exist in the SwMI. If the call can be performed in the participating SwMI, then send a set-up request to the dispatcher.
- PCAD'3 The dispatcher has accepted the call. Inform the controlling SwMI.
- PCAD'4 The dispatcher wishes to set-up a call to the calling user (on-demand call set-up).
- PCAD'5 Send the connect acknowledge PDU to the dispatcher.
- PCAD'6 The incoming group call has been accepted by the dispatcher.

## Annex C (informative): Static description of the TETRA group call bearer service, using attributes

Reformulating the corresponding information defined in EN 300 392-2 [3] leads to the static description of TETRA bearer service attributes given below using the relevant attributes with the corresponding values as defined in ITU-T Recommendation I.140 [i.3].

- |                                     |  |
|-------------------------------------|--|
| 1) Information transfer mode:       | circuit  |
| 2) Information transfer rate:       | from 2,4 kbit/s up to $4 \times 7,2$ kbit/s (= 28,8 kbit/s) (in the case of data transmission) - see clause 14.8.2 of EN 300 392-2 [3]   |
| 3) Information transfer capability: | all TETRA circuit mode bearer and tele- services   |
| 4) Structure:                       | for single slot communications: "service data unit integrity" for telephony calls and for end-to-end encrypted data calls, and "unstructured" for other data calls;<br><br>for multislot communications: "Time Slot Sequence Integrity" (TSSI) |

NOTE: According to clause 4.5.1 of EN 300 392-2 [3] the air interface time slots comprise 510 bits (possibly only half, in special cases), sent at a data rate of 36 kbit/s (hence a timeslot duration of 14,167 ms). Depending on the type of traffic channel that they carry, these 510 bit time slots carry layer 3 service data units possibly completed by error control bits and interleaved between N time slots of different lengths (e.g. 432 bits for 7,2 kbit/s traffic channel, or 288 bits for 4,8 kbit/s traffic channel). The above statement about the value of the attribute structure in the case of telephony calls and of end-to-end encrypted data calls means that the corresponding layer 3 service data units have to be delivered transparently to the destination access point.

On the other hand, it is clear that the order of the time slots at the air interface should be kept end-to-end in multi-slot communications, hence the structure "TSSI".

- |   |   |
|---|---|
| 5) Establishment of communication:      | demand  |
| 6) Symmetry:                            | bi-directional symmetric for duplex operation, and unidirectional for half-duplex operation                 |
| 7) Communication configuration:         | point-to-multipoint (since the communication is a group call)   |
| 8) Access channel and rate:             | TDMA timeslot, at a rate of 9 kbit/s  |
| 9) Access protocol:                     | air interface protocols for both signalling and user information - as defined in EN 300 392-2 [3]           |
| 10) Supplementary services provided:    | in line with ITU-T Recommendation I.210 [i.4], the definition of the value of this attribute is under study |
| 11) Quality of Service (QOS):           | in line with ITU-T Recommendation I.210 [i.4], the definition of the value of this attribute is under study |
| 10) Interworking capability:            | according to ITU-T Recommendation I.140 [i.3], the possible values of this attribute remain to be defined   |
| 11) Operational and commercial aspects: | according to ITU-T Recommendation I.140 [i.3], the possible values of this attribute remain to be defined   |

---

## Annex D (informative): Definition of the ISI ROSE operation

The ROSE operation in support of TETRA encoding PDU is defined in EN 300 392-3-1 [4], clause 8.4.1.





### E.1.2 Single calling party, some queuing for resources

- CSwMI connects when the OSwMI is ready; and
- the CSwMI waits for all responses to its ISI-SETUP-INITIATE PDU before determining if the call can be connected. Refer to figure E.2.

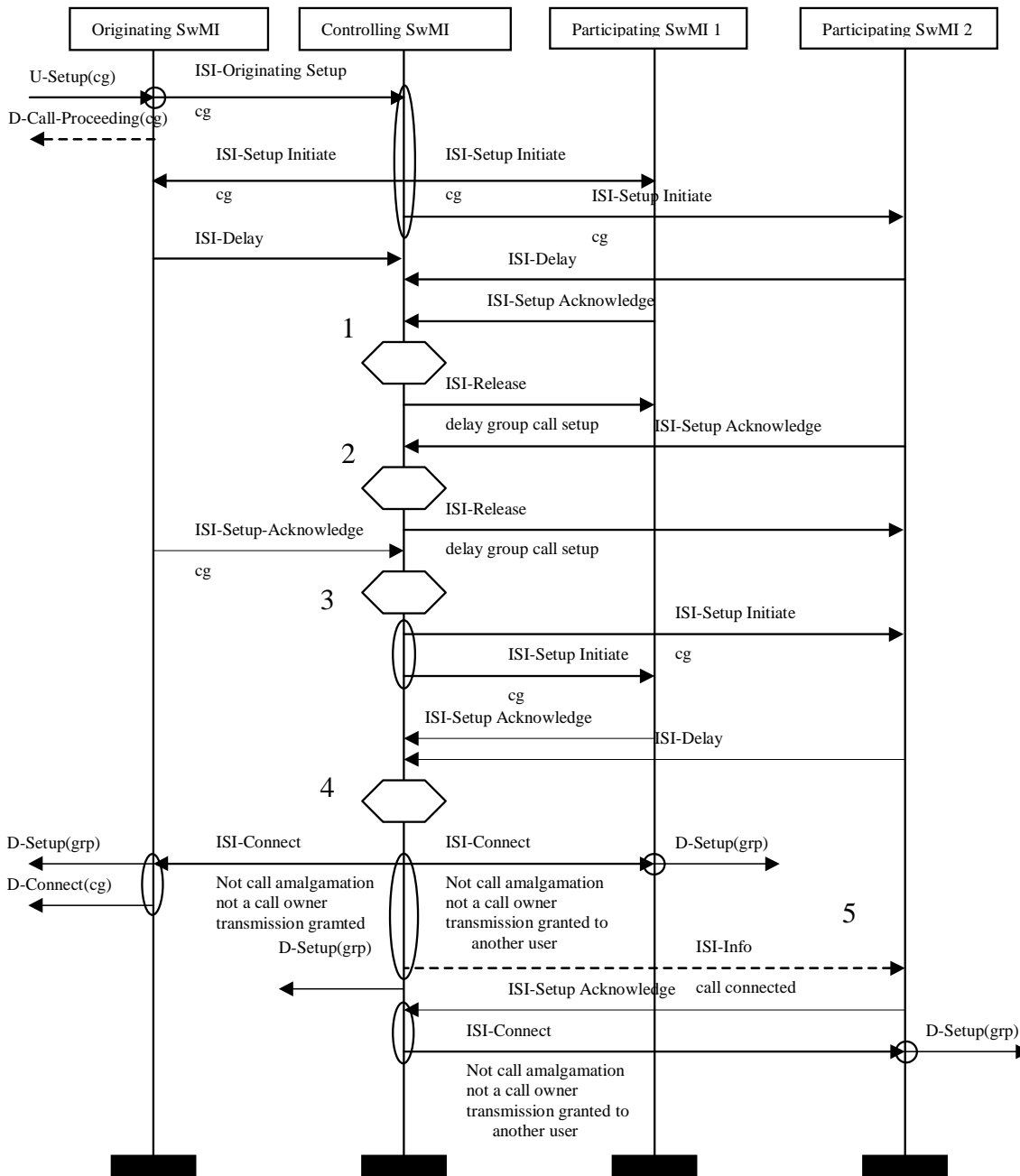


Figure E.2: Successful group call set-up: single calling party, some queuing for resources

NOTE 1: CSwMI waits for all initial responses (ISI-SETUP-ACKNOWLEDGE or ISI-DELAY PDU) from all external SwMIs. It then performs an evaluation to determine if the call should be delayed (i.e. ISI-RELEASE PDU sent to ready SwMIs) or a partial call setup (i.e. send ISI-CONNECT PDU to ready SwMIs). In this case, since the CSwMI wants an OSwMI to be ready before it connects, but as it is not, it decides to delay the call.

NOTE 2: Any ISI-SETUP-ACKNOWLEDGE PDU received after the CSwMI has delayed the call causes a new re-evaluation of what the CSwMI should do. The alternatives are to continue to delay the call (send an ISI-RELEASE PDU to the newly ready SwMI) or attempt to get the call to setup (by initiating the call again to all delayed SwMIs). In the example since the OSwMI is still not ready the CSwMI decides to continue to delay the call.

NOTE 3: The condition that the CSwMI is looking for is fulfilled when the ISI-SETUP-ACKNOWLEDGE PDU comes in from the calling party. As in 2) a re-evaluation is performed but this time a decision is taken to try to reactivate the call. This is because the call can now be connected. To do this an ISI-SETUP-INITIATE PDU is sent to all delayed SwMIs (those that have been sent ISI-RELEASE PDU).

NOTE 4: When all of the responses to the ISI-Setup-Initiate have been received (ISI-SETUP-ACKNOWLEDGE or ISI-DELAY PDU) then another re-evaluation is performed. In this example, it can decide nothing other than to connect the call, so ISI-CONNECT PDU is sent to all SwMIs that are ready to connect. In the example one of the SwMIs is not ready to connect. It will be connected later when it sends in its ISI-SETUP-ACKNOWLEDGE PDU.

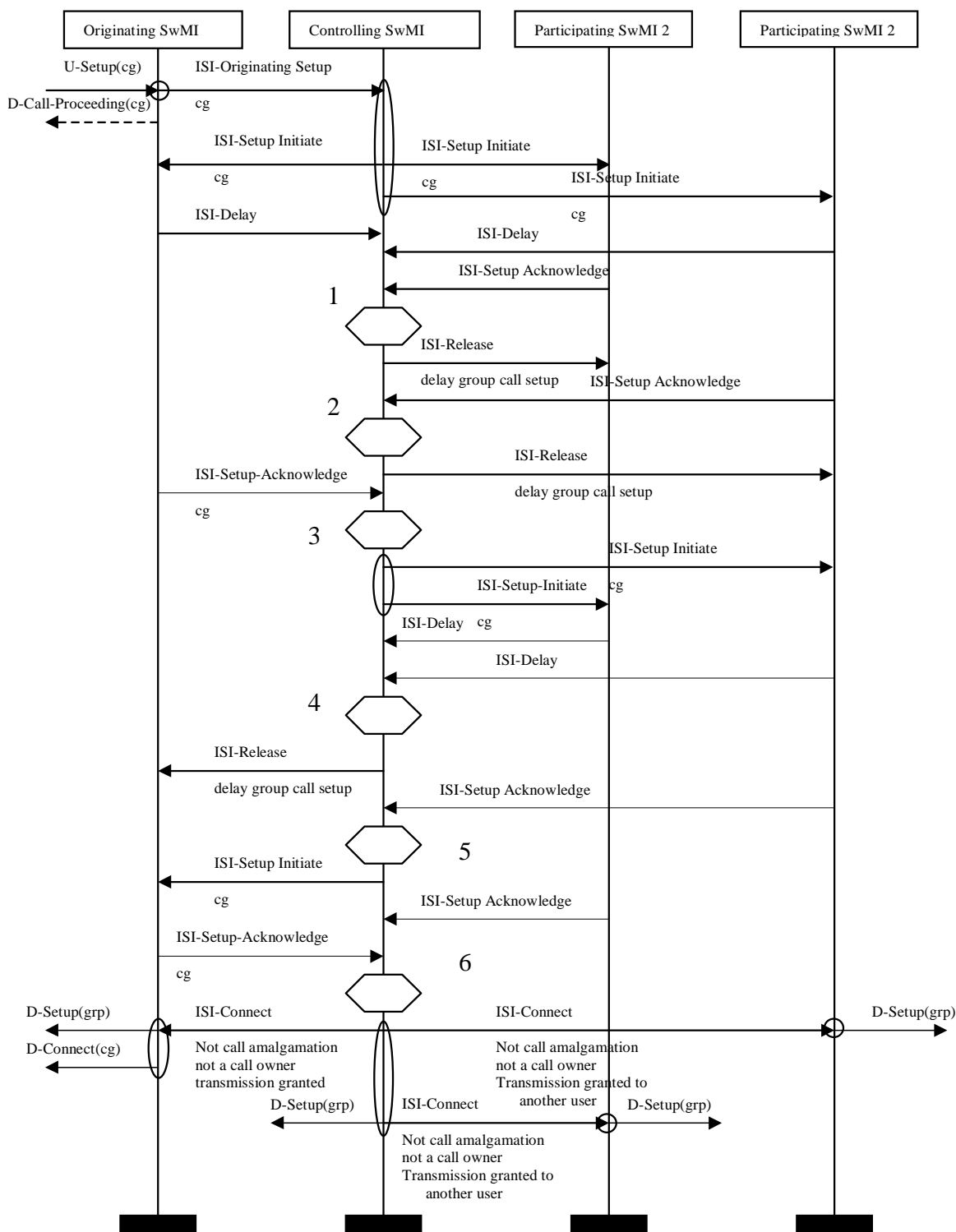
NOTE 5: If the delaying SwMIs strategy on sending in its ISI-SETUP-ACKNOWLEDGE PDU is to wait for more than one of its called parties to be ready then there will be parties that are ready but have not been connected into the call. The PSwMI may take account of the ISI-INFO PDU (call connected) to return its ISI-SETUP-ACKNOWLEDGE PDU when a party can be connected into the call, thus avoiding the problem.

It is possible that the call has been connected without a calling party. This would be the case if the OSwMI had not based the sending in of its ISI-SETUP-ACKNOWLEDGE PDU on the basis of its called party being ready (for example it could have sent it in based on any party (called or calling) being available, and it was a called party that was available).

It is possible (but probably unlikely) that the call could have been connected with no called parties. This assumes that there are no ready called parties at the OSwMI and that the PSwMI did not wait for called parties to be ready before sending in its ISI-SETUP-ACKNOWLEDGE PDU.

### E.1.3 Single calling party, some queuing for resources, different connect strategy

- CSwMI connects when the OSwMI and a PSwMI is ready; and
- the CSwMI waits for all responses to its ISI-SETUP-INITIATE PDU before determining if the call can be connected. Refer to figure E.3.



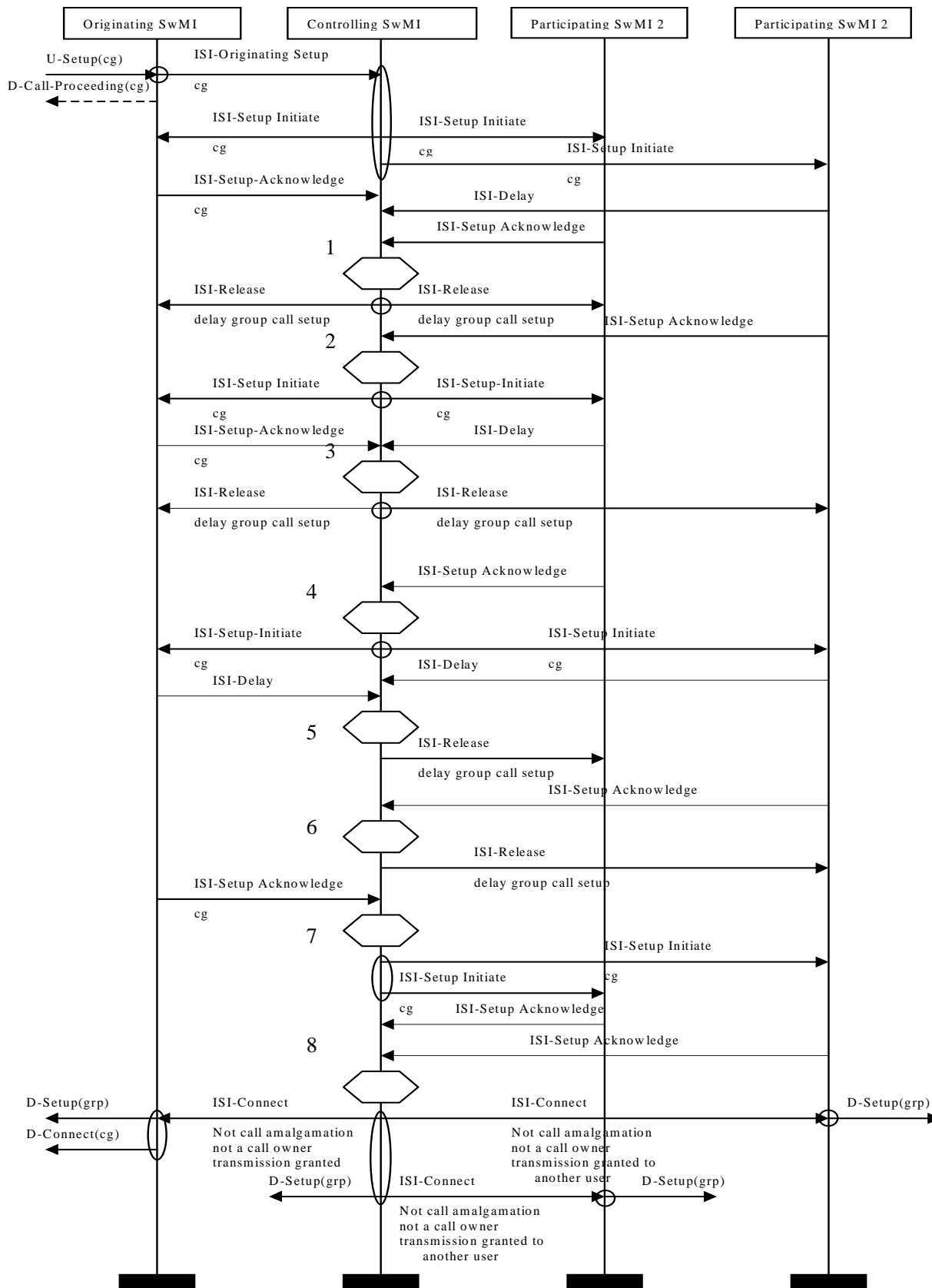
**Figure E.3: Successful group call set-up: single calling party, some queuing for resources, different connect strategy to clause E.1.2**

NOTE 1: CSwMI waits for all initial responses (ISI-SETUP-ACKNOWLEDGE or ISI-DELAY PDU) from all external SwMIs. It then performs an evaluation to determine if the call should be delayed (i.e. ISI-RELEASE PDU sent to ready SwMIs) or a partial call setup (i.e. send ISI-CONNECT PDU to ready SwMIs). In this case since the CSwMI wants the OSwMI and a PswMI to be ready before it connects, but only a PswMI is ready, it decides to delay the call.

- NOTE 2: Any ISI-SETUP-ACKNOWLEDGE PDU received after the CSwMI has delayed the call causes a new re-evaluation of what the CSwMI should do. The alternatives are to continue to delay the call (send an ISI-RELEASE PDU to the newly ready SwMI) or attempt to get the call to setup (by initiating the call again to all delayed SwMIs). In the example part of the conditions the CSwMI needs have been fulfilled, a PSwMI is ready, however since the OSwMI is delaying the CSwMI decides to continue to delay the call.
- NOTE 3: As in note 2 a re-evaluation is performed when an ISI-SETUP-ACKNOWLEDGE PDU is received but the CSwMI is delaying the call. This time a decision is taken to try to reactivate the call, this is because the OSwMI is now available and if one of the delayed PSwMIs was still to be available then the call could be connected. To do this an ISI-SETUP-INITIATE PDU is sent to all delayed SwMIs (those that have been sent ISI-RELEASE PDU).
- NOTE 4: When all of the responses from the SwMIs that have been sent the ISI-SETUP-INITIATE PDU have been received (ISI-SETUP-ACKNOWLEDGE or ISI-DELAY PDU) then another re-evaluation is performed. In this example, both of the PSwMIs have sent an ISI-DELAY PDU. The CSwMI has not met the conditions it needs to connect the call and so decides that the call should again be delayed. It sends ISI-RELEASE PDU to all SwMIs that are ready. In this case this is only the OSwMI.
- NOTE 5: The receipt of an ISI-SETUP-ACKNOWLEDGE PDU while the call is being delayed causes a new re-evaluation by the CSwMI of what it should do next. The CSwMI still only has part of the condition satisfied that it needs to connect the call (it has only a PSwMI available). Since the OSwMI is currently being delayed by the CSwMI, the CSwMI now decides it must attempt to reactivate the call again. It sends an ISI-SETUP-INITIATE PDU to all delayed SwMIs. In this case this is only the OSwMI.
- NOTE 6: The first ISI-SETUP-ACKNOWLEDGE PDU to arrive is from the delaying PSwMI. This does not cause a re-evaluation of what the CSwMI should do, since the CSwMI is looking for responses from all of the SwMIs to which it has just sent an ISI-SETUP-INITIATE PDU. This is not one of them (however, the CSwMI must remember that this PSwMI is no longer delaying itself). The next ISI-SETUP-ACKNOWLEDGE PDU is from the OSwMI. Since all of the responses that the CSwMI had been looking for have now come in a re-evaluation is performed. This determines that both an OSwMI and a PSwMI are now available for connection. Therefore, the call is connected.

#### E.1.4 Single calling party, some queuing for resources, showing multiple releasing

- CSwMI connects when all SwMIs are ready.
- The CSwMI waits for all responses to its ISI-SETUP-INITIATE PDU before determining if the call can be connected. Refer to figure E.4.



**Figure E.4: Successful group call set-up: single calling party, some queuing for resources, showing multiple releasing**

NOTE 1: After receiving all the expected responses the CSwMI delays the call since it does not have all SwMIs ready.

NOTE 2: Re-evaluation while delaying. Decides in this case to re-activate the call since all of the other SwMIs, other than the one that just said it was ready, are being delayed.

NOTE 3: A re-evaluation of what to do when all responses from the previous re-activation have been received. In this example the CSwMI delays the call again since it needs all three SwMIs to be available before connecting the call and one of them has delayed.

NOTE 4: Re-evaluation while delaying. The only delaying SwMI is now ready, so the CSwMI decides to re-activate the call.

NOTE 5: The CSwMI waits for all expected responses. When they arrive both indicate that the sending SwMIs are not ready to connect.

NOTE 6: Re-evaluation while delaying. Since one other SwMI is still delaying the CSwMI decides to delay the call.

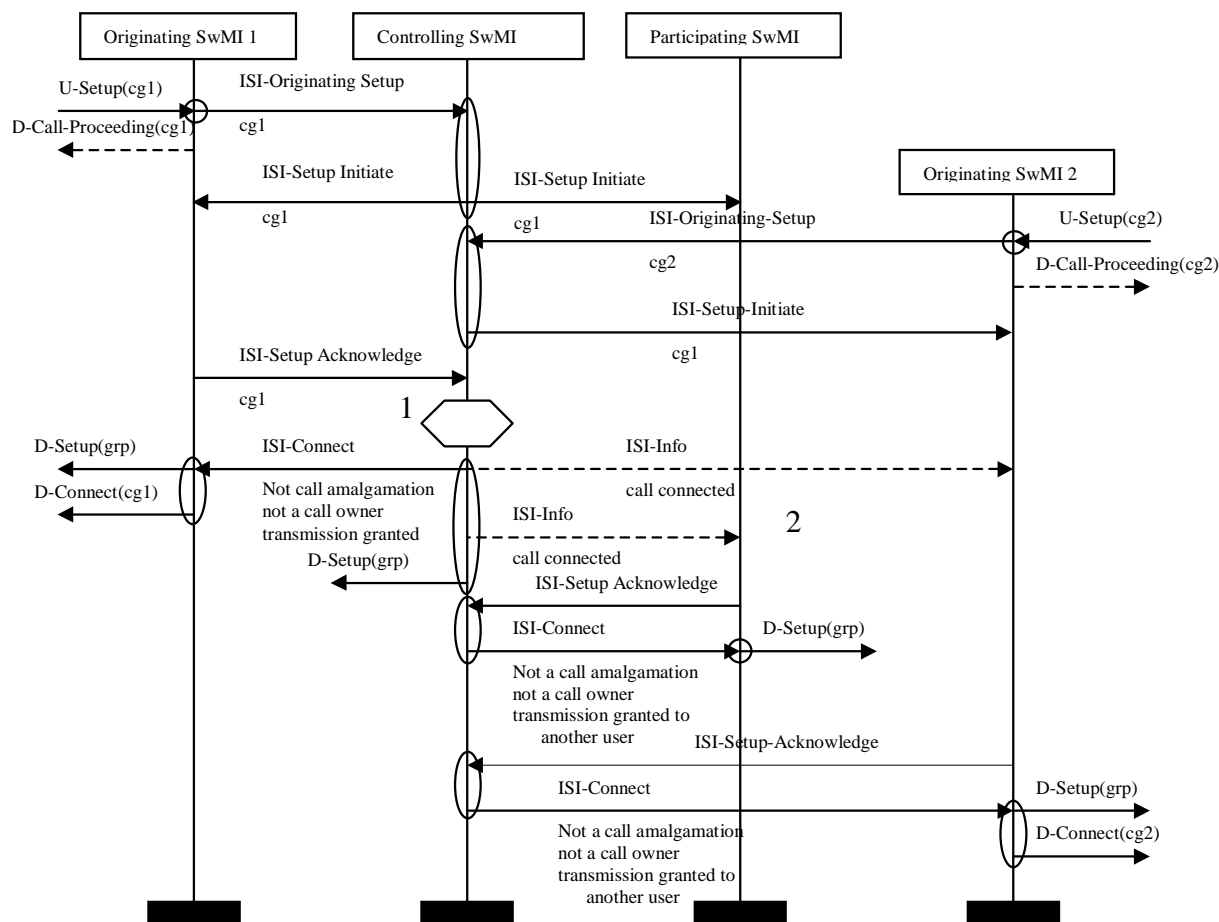
NOTE 7: Re-evaluation while delaying. No other SwMI is now delaying so the CSwMI decides to re-activate the call.

NOTE 8: Once all of the expected responses have been received the CSwMI re-evaluates what it should do. At last it has all of the SwMIs ready, so it connects the call.

The "ping ponging" (the continual release and reacquisition of resources, while never quite getting all of the resources needed to connect the call) could go on for some considerable time. However, it cannot exceed the length of the "call timeout, set-up phase" timer.

### E.1.5 Multiple calling parties, a new calling party is on a SwMI not currently in the call

- CSwMI connects when an OSwMI is ready.
- The CSwMI does not wait for all responses to its ISI-Setup-Initiate before determining if the call can be connected. Refer to figure E.5.



**Figure E.5: Successful group call set-up: multiple calling parties, a new calling party is on a SwMI not currently in the call**

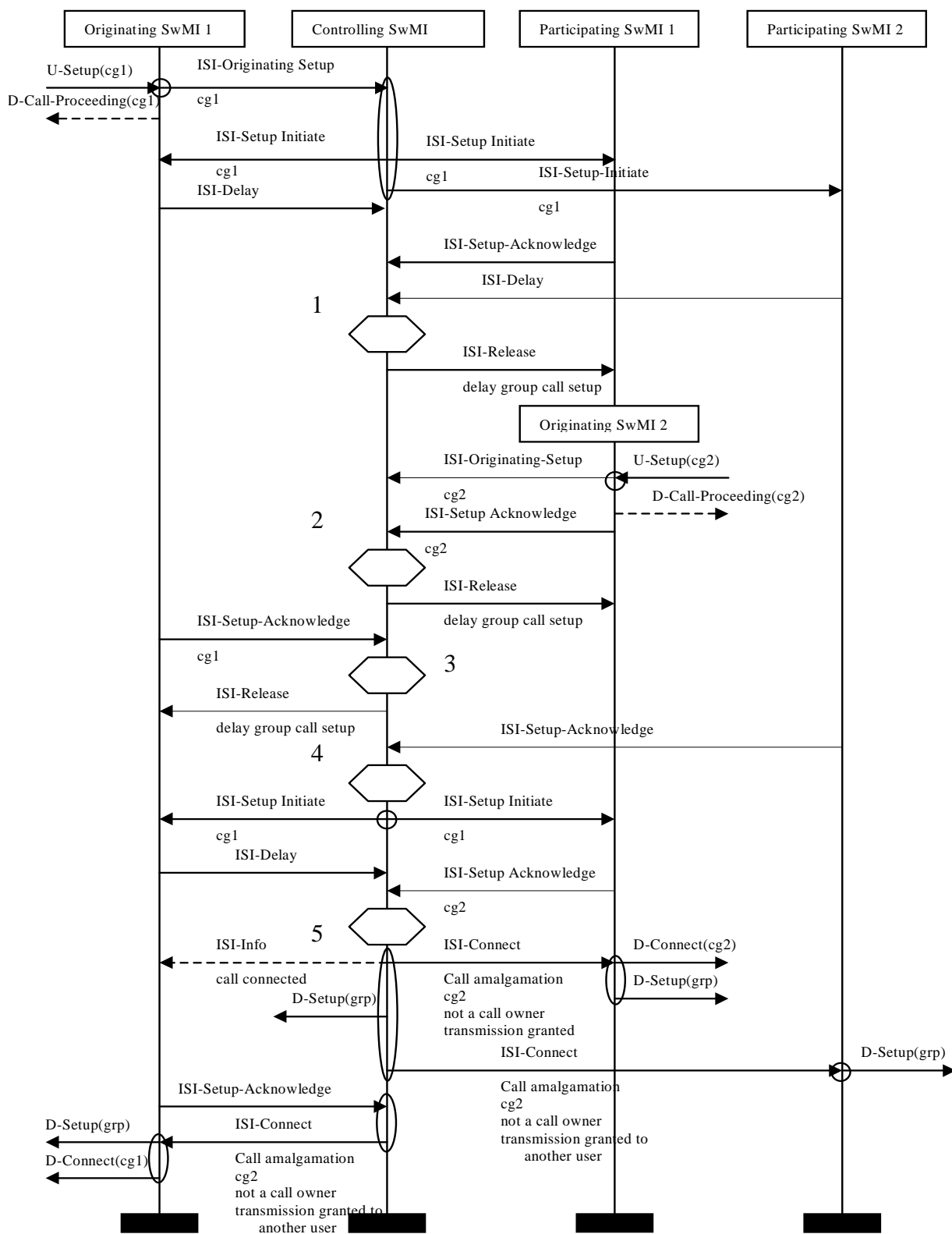
NOTE 1: The CSwMI does not wait for all initial responses (ISI-SETUP-ACKNOWLEDGE or ISI-DELAY PDU) from all external SwMIs. In this example the first response to come in, the ISI-SETUP-ACKNOWLEDGE PDU from the OSwMI meets the CSwMI connection criteria. It therefore partially connects the call immediately and ISI-INFO PDUs are sent to all other SwMIs to inform them that the call has connected. A new OSwMI, that had no called parties, joined the call before the CSwMI connected it. The remaining SwMIs, including the newly joined SwMI, are connected into the call as soon as they are ready.

NOTE 2: The ISI-INFO PDUs could cause the receiving SwMIs to send back their ISI-SETUP-ACKNOWLEDGES PDU sooner than was otherwise the case. This is because the SwMIs know that the call has connected and that any of their parties that are ready should be connected into the call.

### E.1.6 Multiple calling parties the second calling OSwMI is ready first. The new setup from the second OSwMI is received while the CSwMI is delaying the call

- CSwMI connects when an OSwMI and one PSwMI is ready.
- The CSwMI waits for all responses to its ISI-SETUP-INITIATE PDU before determining if the call can be connected. Refer to figure E.6.





**Figure E.6: Successful group call set-up: multiple calling parties the second calling OSwMI is ready first, the new setup from the second OSwMI is received while the CSwMI is delaying the call**

NOTE 1: After having waited for all of the expected responses the CSwMI decides that it must delay the call since it has not met the criteria it needs for call connection.

NOTE 2: The new OSwMI sends in both its ISI-ORIGINATING-SETUP and ISI-SETUP-ACKNOWLEDGE PDU while the CSwMI is delaying the call. The CSwMI performs the usual re-evaluation, on receipt of the ISI-SETUP-ACKNOWLEDGE PDU, while it is has delayed the call. Since the conditions needed for connection have not been met (no PswMI) and the only PswMI in the call is delaying the CSwMI decides to continue to delay the call. This illustrates an inefficiency, the OSwMI 1 will probably be basing the sending of its ISI-SETUP-ACKNOWLEDGE PDU on having its calling party ready. In the situation of the example, it should probably say it is ready when any of its parties are ready. However, it has not been provided with any information that could allow it to decide to change its rule. This situation would not arise if the connection at the CSwMI were to be based only on having an OSwMI ready.

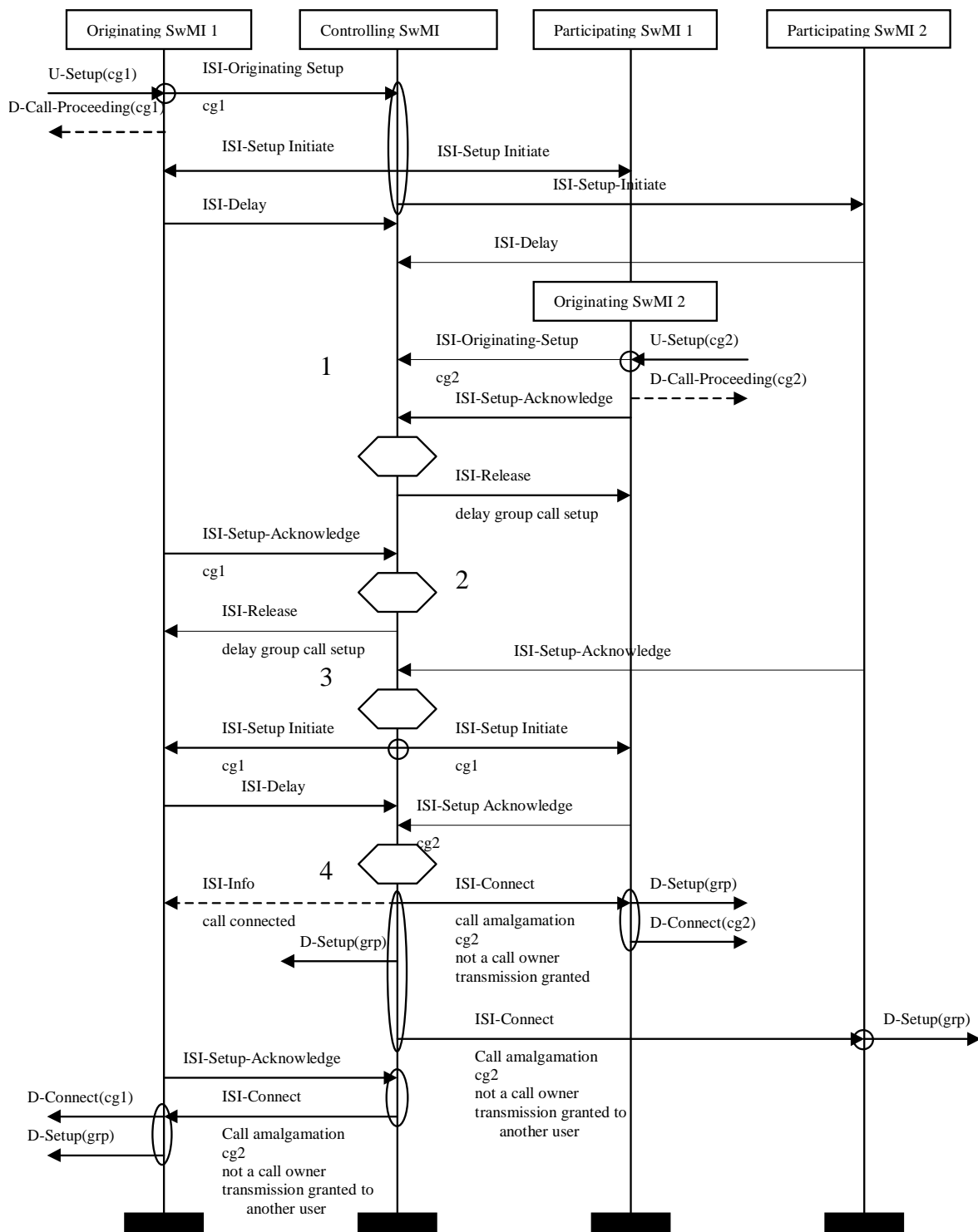
NOTE 3: Re-evaluation during call delay. The CSwMI decides to continue to delay the call. Since it does not have the conditions it needs to connect the call and the only PswMI in the call is still delaying. An alternative could be for the CSwMI to attempt to reinitiate the call since it has an OSwMI ready and would have another OSwMI ready if OswMI 2 reinitialized. This would require a connection rule in the CSwMI that allowed having two, or more, OSwMIs as enough to connect the call.

NOTE 4: Re-evaluation during call delay. The PswMI is now ready and so, since both of the OSwMIs are now delayed the CSwMI decides to re-activate the call.

NOTE 5: When all of the expected responses are received, the usual re-evaluation determines that the call can now be connected. The delaying OSwMI is sent an ISI-INFO PDU (call connected) so that it is informed of the fact that the call has connected and so that it can decide if it wants any of its ready parties to also be connected into the call.

### **E.1.7 Multiple calling parties the second calling OSwMI is ready first. The new setup from the second OSwMI is received while the CSwMI is activating the call**

- CSwMI connects when an OSwMI and one PswMI is ready.
- The CSwMI waits for all responses to its ISI-SETUP-INITIATE PDU before determining if the call can be connected. Refer to figure E.7.



**Figure E.7: Successful group call set-up: multiple calling parties the second calling OSwMI is ready first, the new setup from the second OSwMI is received while the CSwMI is activating the call**

NOTE 1: After having waited for all of the expected responses the CSwMI decides that it must delay the call since it has not met the criteria it needs for call connection. The "PSwMI/new OSwMI" changed the condition it uses to send in the ISI-SETUP-ACKNOWLEDGE PDU based on the fact that it is now an OSwMI rather than a PSwMI.

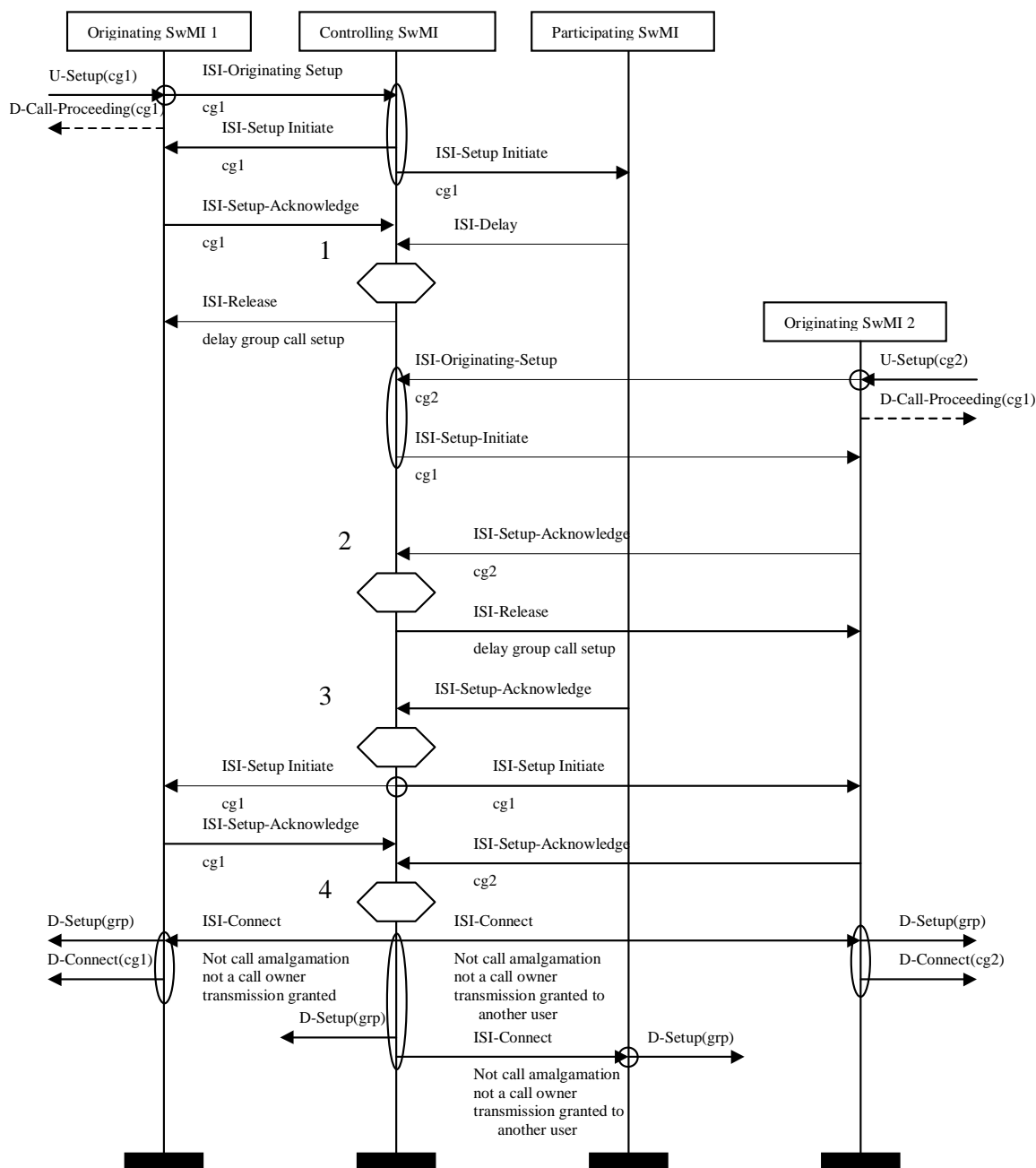
NOTE 2: Re-evaluation during call delay. The CSwMI decides to continue to delay the call because it does not have the conditions it needs to connect the call and the only PSwMI in the call is still delaying. An alternative could be for the CSwMI to attempt to reinitiate the call since it has an OSwMI ready and would have a PSwMI if PSwMI 1 initialized. It depends entirely on the design of the CSwMIs re-evaluation algorithms what actually happens.

NOTE 3: Re-evaluation during call delay. The PSwMI is now ready and so, since both of the OSwMIs are now delayed the CSwMI decides to re-activate the call.

NOTE 4: When all of the expected responses are received, the usual re-evaluation determines that the call can now be connected. An ISI-INFO PDU (call connected) is sent to all delaying SwMIs at this time.

## E.1.8 Multiple calling parties the second calling OSwMI is ready first

- CSwMI connects when all SwMIs are available.
- The CSwMI waits for all responses to its ISI-Setup-Initiate before determining if the call can be connected. Refer to figure E.8.



**Figure E.8: Successful group call set-up: multiple calling parties the second calling OSwMI is ready first**

NOTE 1: After having waited for all of the expected responses the CSwMI decides that it must delay the call since it has not met the criteria it needs for call connection. It needs all SwMIs to be available but only one of them is.

NOTE 2: The new OSwMI has been added to the list of SwMIs in the call. Therefore, the ISI-SETUP-ACKNOWLEDGE PDU from the new OSwMI causes a re-evaluation during call delay. The CSwMI decides to continue to delay the call. Since it does not have the conditions it needs to connect the call and the PSwMI in the call is still delaying. An alternative strategy here could be for the CSwMI to attempt to reinitiate the call. It depends entirely on the design of the CSwMIs re-evaluation algorithms what actually happens.

NOTE 3: Re-evaluation during call delay. The PSwMI is now ready and so, since both of the OSwMIs are now delayed the CSwMI decides to re-activate the call.

NOTE 4: When all of the expected responses are received, the usual re-evaluation determines, in this example, that the call can now be connected.

### E.1.9 Multiple calling parties the second calling OSwMI is ready first. Shows parties not connected into the call that could have been

- CSwMI connects when an OSwMI and one PSwMI are ready.
- The CSwMI does not wait for all responses to its ISI-SETUP-INITIATE PDU before determining if the call can be connected. Refer to figure E.9.

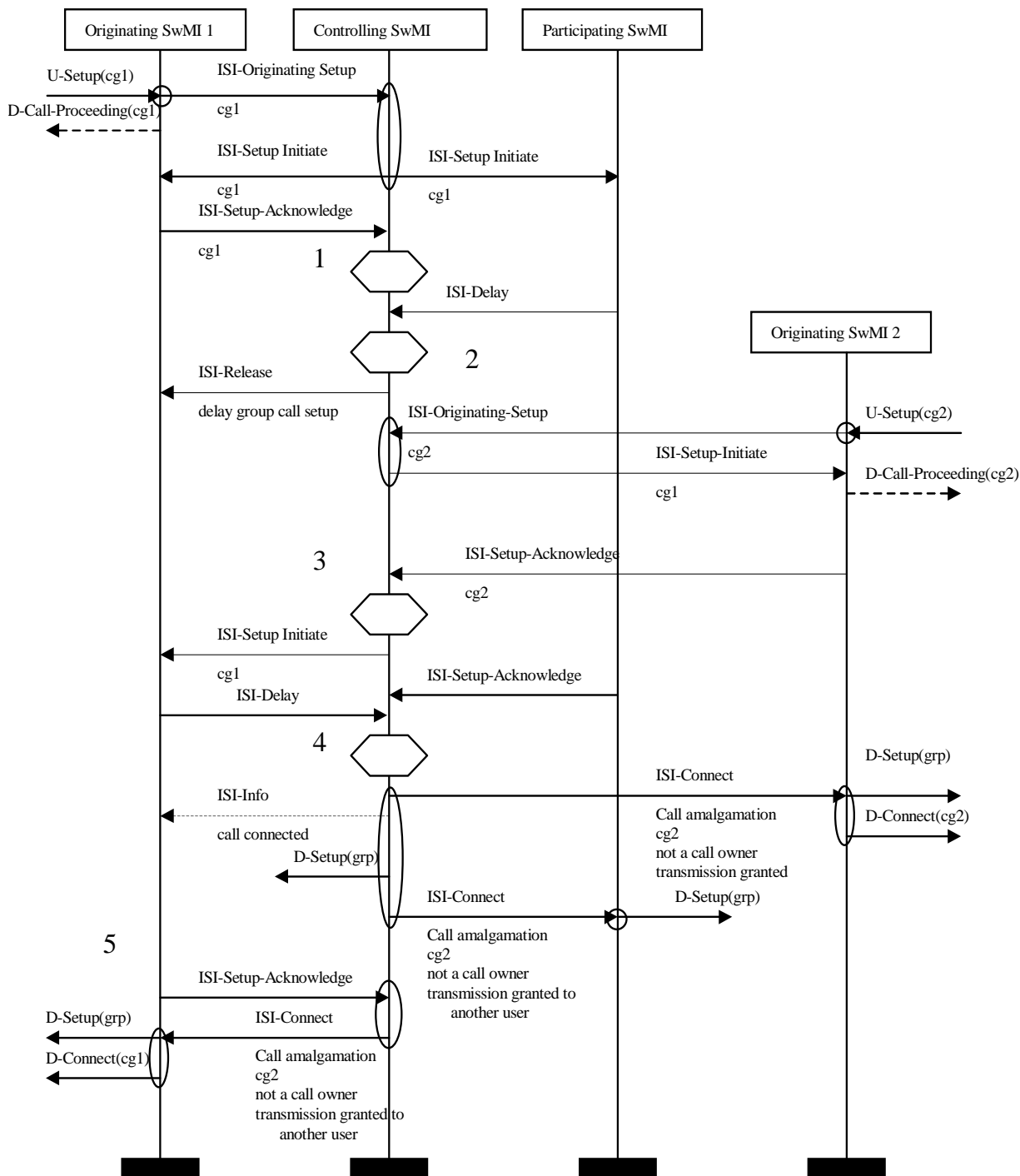
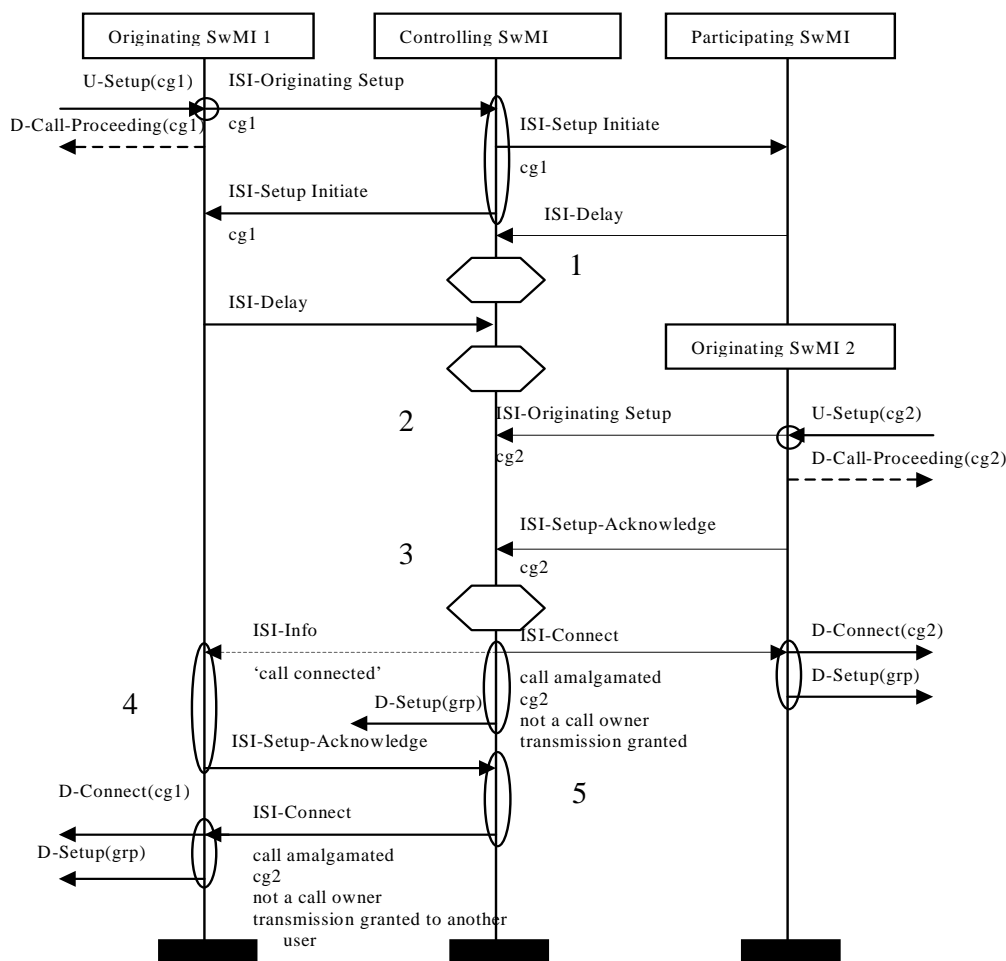


Figure E.9: Successful group call set-up: multiple calling parties the second calling OSwMI is ready first. Shows parties not connected into the call that could have been

- NOTE 1: The CSwMI is not waiting for all responses for its ISI-SETUP-INITIATE PDU so it evaluates every response it receives to determine if the call can be connected, delayed or left as it is. The first response is an ISI-SETUP-ACKNOWLEDGE PDU from the OSwMI; this in itself does not meet the criteria for connection, which requires both an OSwMI and a PSwMI to be ready. Since all expected responses have not yet been received, the decision is to leave the call as it is.
- NOTE 2: The next response is the last expected to the ISI-SETUP-INITIATE PDU the CSwMI decides that it must delay the call since it has not met the criteria it needs for call connection, and all expected responses have arrived. It needs a PSwMI to be available, but it is not.
- NOTE 3: The new OSwMI has been added to the list of SwMIs in the call. Therefore, the ISI-SETUP-ACKNOWLEDGE PDU from the new OSwMI causes a re-evaluation during call delay. The CSwMI decides to re-initiate the call, since having two OSwMIs in the call should be enough to connect it. This illustrates a changing condition used by the CSwMI to connect the call, or a more complicated fixed rule, such as the CSwMI connects when it has an OSwMI and another SwMI ready. An alternative course of action from the CSwMI would be for it to continue to delay. It could do this because the PSwMI is still delaying, and the response from the PSwMI would kick off re-evaluation again. It depends entirely on the design of the CSwMI's re-evaluation algorithms what actually happens.
- NOTE 4: The CSwMI receives an ISI-SETUP-ACKNOWLEDGE PDU from the PSwMI. Since the CSwMI does not have to wait for the expected response from the ISI-SETUP-INITIATE PDU it can re-evaluate immediately to decide what to do next. Because the PSwMI is ready the CSwMI has the conditions it needs to connect the call. If the PSwMI had not become ready, then the CSwMI may have delayed the call again or waited for the expected response from the OSwMI.
- NOTE 5: The OSwMI, since it has received an ISI-INFO PDU (call connected), sends back its ISI-SETUP-ACKNOWLEDGE PDU because it knows it has at least one party that is capable of being connected into the call. It no longer has to wait for its calling party to be ready before returning the ISI-SETUP-ACKNOWLEDGE PDU. If the OSwMI had decided to ignore the ISI-INFO PDU, and it had parties that could be connected into the call, these parties would not be connected until the OSwMI's conditions for sending its ISI-SETUP-ACKNOWLEDGE PDU are met.

### E.1.10 Multiple calling parties the second calling OSwMI is ready first

- CSwMI connects when an OSwMI is ready.
- The CSwMI does not wait for all responses to its ISI-SETUP-INITIATE PDU before determining if the call can be connected. Refer to figure E.10.



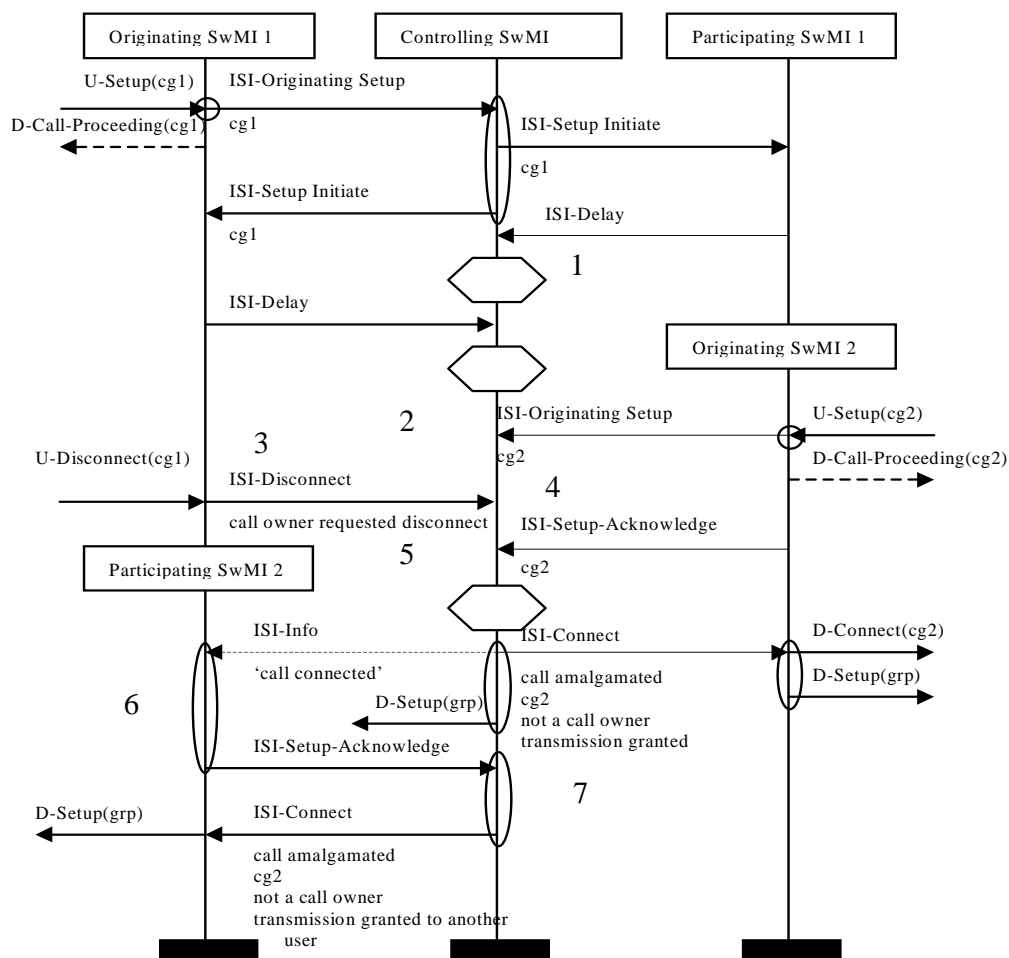
**Figure E.10: Successful group call set-up: multiple calling parties the second calling OSwMI is ready first**

- NOTE 1: Since the CSwMI is not waiting for all responses to its ISI-SETUP-INITIATE PDU to determine what to do next, it performs an evaluation on every response to check if the call should be connected, delayed or left in its current state. In the example, the decision is neither to connect or delay since a response from another SwMI is still expected.
- NOTE 2: When the final expected response is received, the CSwMI decides that it must delay the call since it has not met the criteria it needs for call connection. However, since all of the external SwMIs are delaying the call there are no ISI-RELEASE PDUs to be sent.
- NOTE 3: The new OSwMI is recorded, by the CSwMI. Therefore, the ISI-SETUP-ACKNOWLEDGE PDU from the new OSwMI causes a re-evaluation during call delay. The CSwMI decides to connect the call since it now has an OSwMI in the call the ISI-CONNECT and ISI-INFO PDUs are sent.
- NOTE 4: When the call connects the delaying SwMIs are informed. In the example, the OSwMI 1 decides that since it already has a party that can be connected into the call it immediately responds with its ISI-SETUP-ACKNOWLEDGE PDU.
- NOTE 5: The CSwMI already being "active" connects the call to the SwMIs that send in ISI-SETUP-ACKNOWLEDGE PDU.



## E.1.11 Multiple calling parties an OSwMI transitions back into a PSwMI

- CSwMI connects when an OSwMI is ready.
- The CSwMI does not wait for all responses to its ISI-SETUP-INITIATE PDU before determining if the call can be connected. Refer to figure E.11.



**Figure E.11: Successful group call set-up: multiple calling parties an OSwMI transitions back into a PSwMI**

- NOTE 1:** Since the CSwMI is not waiting for all responses to its ISI-SETUP-INITIATE PDU to determine what to do next, it performs an evaluation on every response to check if the call should be connected, delayed or left in its current state. In the example, the decision is to neither connect, nor delay since a response from another SwMI is still expected.
- NOTE 2:** When the final expected response is received the CSwMI decides that it must delay the call since it has not met the criteria it needs for call connection. However, since all of the external SwMIs are delaying the call there are no ISI-RELEASE PDUs to be sent.
- NOTE 3:** The calling party at OSwMI1 disconnects from the call. Because there are no other calling parties at OSwMI1 it sends in an ISI-DISCONNECT PDU with the "call owner request" information element set to be "call owner requested disconnect". Because it has other called parties on the SwMI it decides to let the CSwMI choose if it should remain in the call or not. Therefore, its ISI-DISCONNECT PDU is sent in a PSS1 FACILITY message. The OSwMI 1 is now a PSwMI.

NOTE 4: The CSwMI on receiving the ISI-DISCONNECT PDU with the "call owner request" set knows that the OSwMI 1 has changed back into a PSwMI. In the example, because the CSwMI already knows that there is another OSwMI in the call it allows the call to continue. If there had not been another OSwMI in the call, the CSwMI would have disconnected the entire call. No ISI-RELEASE PDU is sent to the new PSwMI 2, since the CSwMI wants the called parties there to be in the call.

NOTE 5: The ISI-SETUP-ACKNOWLEDGE PDU from the new OSwMI 2 causes a re-evaluation during call delay. The CSwMI decides to connect the call since it now has an OSwMI in the call, thus meeting its connection criteria.

NOTE 6: When the call connects the delaying SwMIs are informed. In the example, the PSwMI 2 decides that since it already has called parties present it immediately responds with its ISI-SETUP-ACKNOWLEDGE PDU.

NOTE 7: The CSwMI already being "active" connects the call to the SwMIs that send in ISI-SETUP-ACKNOWLEDGE PDU.

### E.1.12 Multiple calling parties and no PSwMI

- CSwMI connects when an OSwMI and the PSwMI are ready.
- The CSwMI waits for all responses to its ISI-Setup-Initiate before determining if the call can be connected. Refer to figure E.12.

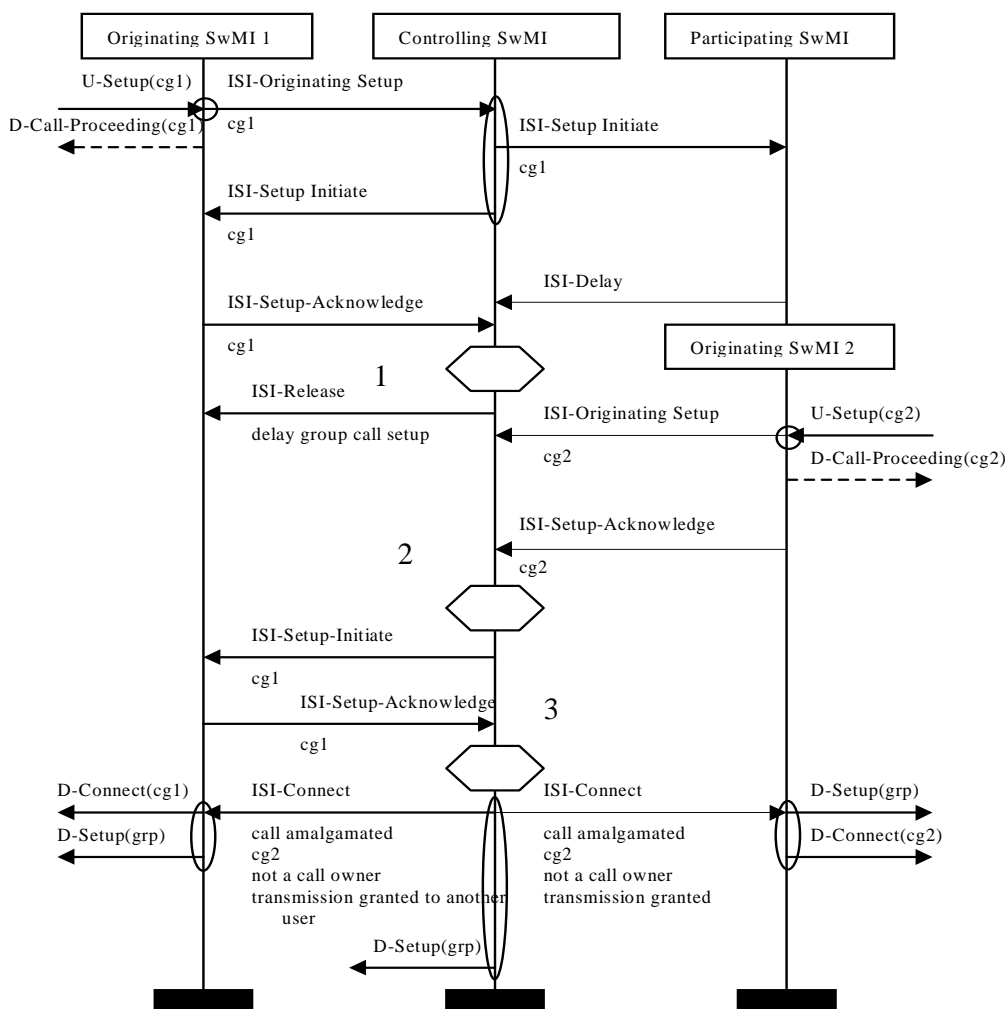


Figure E.12: Successful group call set-up: multiple calling parties and no PSwMI

NOTE 1: After having waited for all of the expected responses the CSwMI decides that it must delay the call since it has not met the criteria it needs for call connection. It has an OSwMI but no PSwMI.

NOTE 2: The new OSwMI has been added to the list of SwMIs in the call. Therefore, the ISI-SETUP-ACKNOWLEDGE PDU from the new OSwMI causes a re-evaluation during call delay. The CSwMI decides to reinitiate the call, since although it does not have the PSwMI it requires to connect the call, it knows that it never will get it since the only PSwMI it had has changed into an OSwMI. This illustrates that a CSwMI with a connection strategy that requires a PSwMI may need to dynamically change the strategy (or have a fixed strategy that says it needs an OSwMI and, if one is available, a PSwMI). Another issue that this highlights is the non optimal conditions being used in OSwMI 1 to indicate it is ready to be connected. This is probably based on its calling party being ready. However, in this situation it should ideally be based on any party being ready. The OSwMI 1 has no information to indicate that it should change its strategy for sending back its ISI-SETUP-ACKNOWLEDGE PDU.

NOTE 3: When the expected response arrives, the re-evaluation decides to connect the call.

### E.1.13 Multiple calling parties at the same SwMI

- CSwMI connects when an OSwMI is ready.
- The CSwMI waits for all responses to its ISI-SETUP-INITIATE PDU before determining if the call can be connected. Refer to figure E.13.

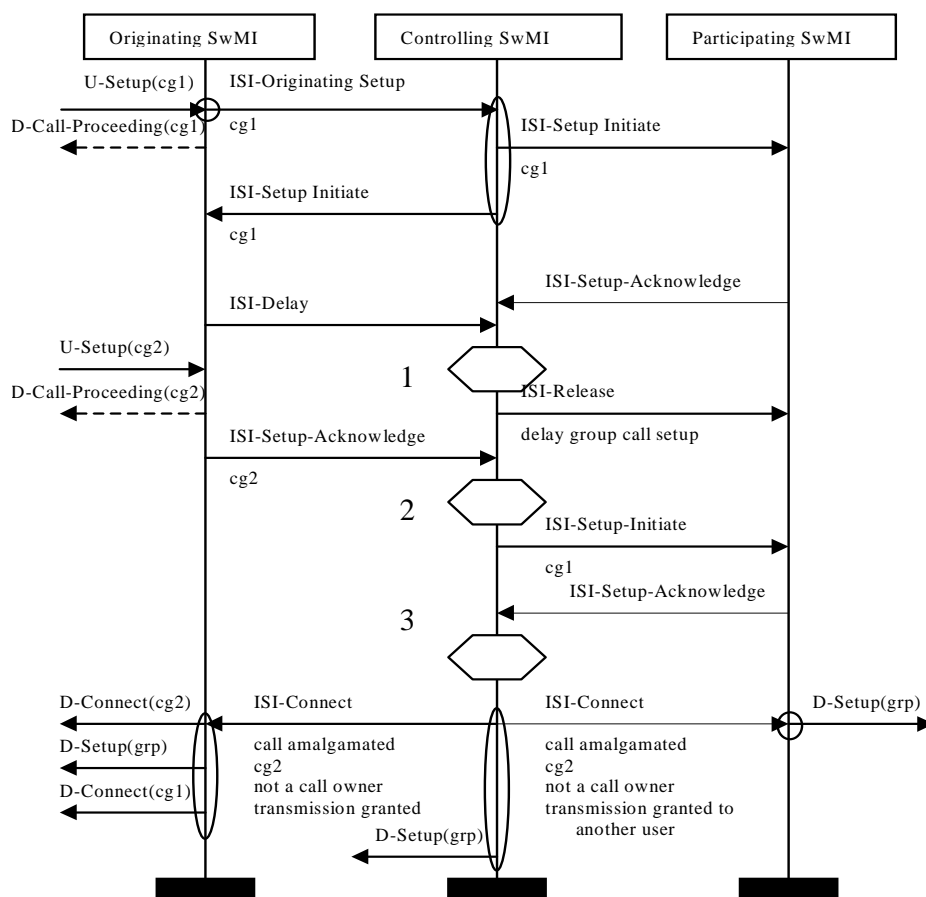


Figure E.13: Successful group call set-up: multiple calling parties at the same SwMI

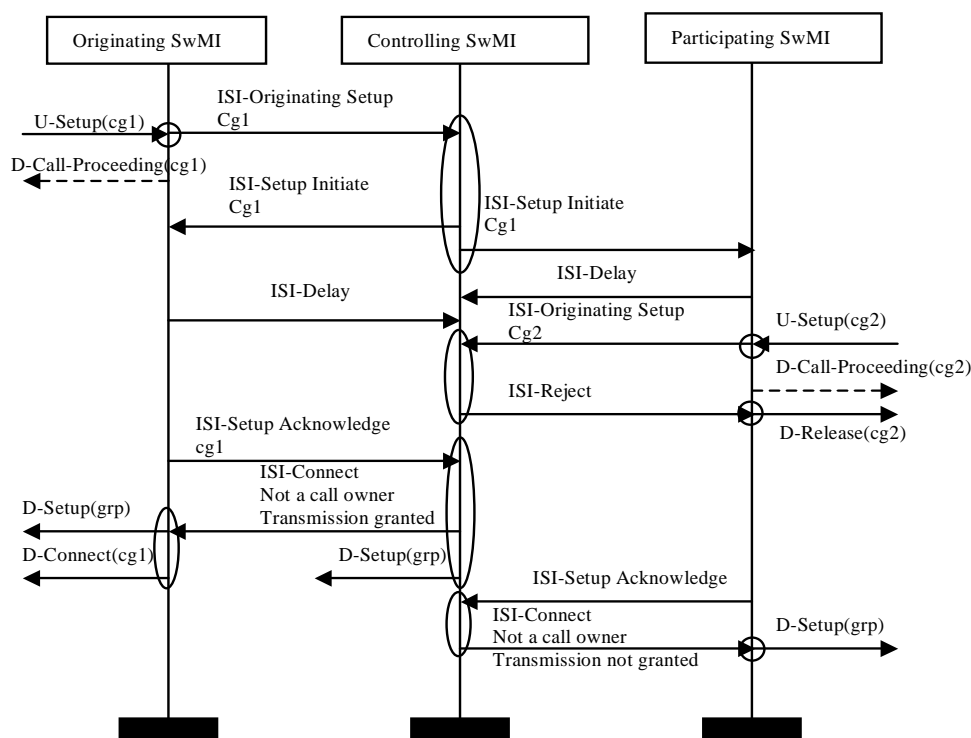
NOTE 1: After having waited for all of the expected responses the CSwMI decides that it must delay the call since it has not met the criteria it needs for call connection. It has no OSwMI.

NOTE 2: When the ISI-SETUP-ACKNOWLEDGE PDU is received, it indicates a different calling party. This means that the OSwMI received a new call request, to the same group. The OSwMI also got the resources needed to connect the new calling party into the call, before those for the original calling party. Since the conditions for connection have now been met, the CSwMI decides to re-initiate the call.

NOTE 3: The call is connected when the PSwMI responds, it does not matter which PDU, ISI-DELAY or ISI-SETUP-ACKNOWLEDGE PDU, the PSwMI responded with, in either case the connection criteria have already been fulfilled. However, it must wait, in this example, for the PDU since the CSwMI does not connect until all responses to its ISI-SETUP-INITIATE PDU have been received.

## E.1.14 Successful Group Call Establishment. The CSwMI does not accept more than one calling party

- CSwMI connects when an OSwMI is ready. Refer to figure E.14.



NOTE 1: The CSwMI may send ISI-REJECT PDU to a subsequent ISI-ORIGINATING-SETUP PDU if it does not support more than one OSwMI.

NOTE 2: The ISI-REJECT PDU is sent in a PSS1 DISCONNECT message only if there are no group call participants at the receiving SwMI otherwise a PSS1-FACILITY message is used.

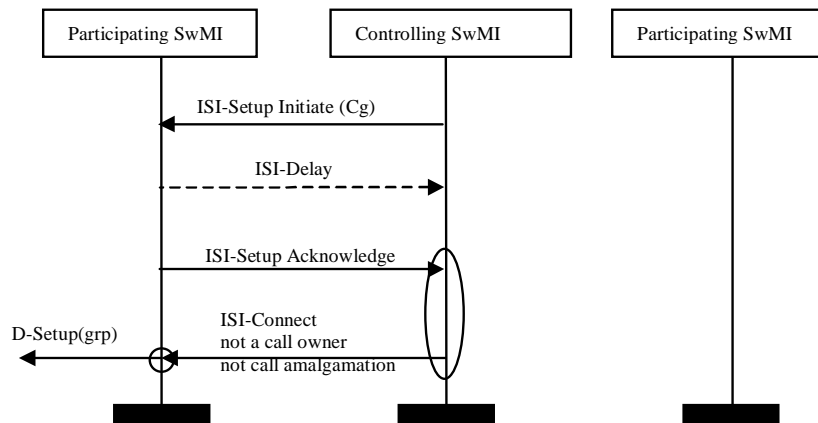
**Figure E.14: Successful group call set-up: CSwMI only supported one calling party**

### Description

A CSwMI may support only a single calling party. If it receives a second setup it may reject it. The call may still be established to the called group members on the rejected PSwMI.

## E.1.15 Late Entry

Refer to figure E.15.



NOTE: A CSwMI may, at any time after call connection, send an ISI-SETUP INITIATE PDU to a SwMI which was not part of the original call but on which group members have since attached. This action may be triggered, for example, by the expiration of a timer causing the CSwMI to re-evaluate the list of PSwMIs, or by the attachment of an MS. It constitutes the ISI part of the Late Entry Supplementary Service. Each SwMI is responsible for operation of SS-LE within it.

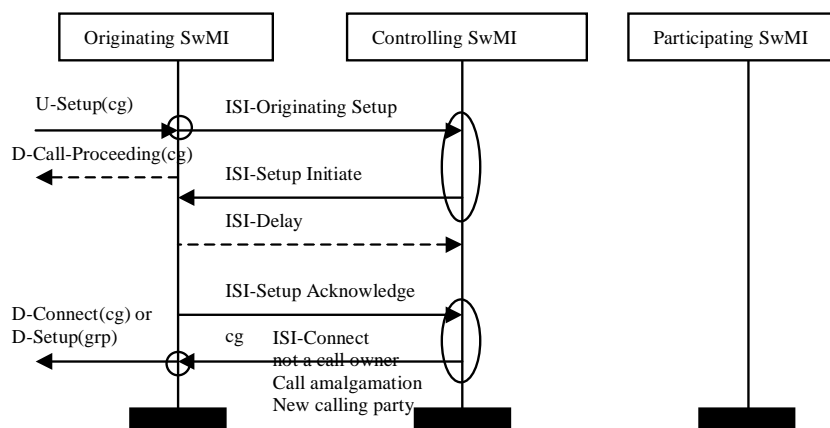
Figure E.15: Late entry

### Description

The CSwMI sends ISI-SETUP INITIATE PDU to a new PSwMI for SS-LE. As the PSwMI does not have sufficient resources to connect it responds with ISI-DELAY PDU. When resources become available, the PSwMI sends ISI-SETUP ACKNOWLEDGE PDU. The CSwMI then connects the PSwMI into the call.

## E.1.16 A SwMI joins with a Connected Call

Refer to figure E.16.



- NOTE 1: The PSwMI and CSwMI are already in a group call that is called by the party at the OSwMI.  
 NOTE 2: The joining party is told that it is not the owner of the call.  
 NOTE 3: The CSwMI may send ISI-REJECT PDU in response to the ISI-ORIGINATING-SETUP PDU if it does not wish to allow the party to enter the existing call.  
 NOTE 4: If the joining mobile or the OSwMI disconnects before the D-CONNECT PDU is sent then only the joining leg of the call is released, not the entire call.

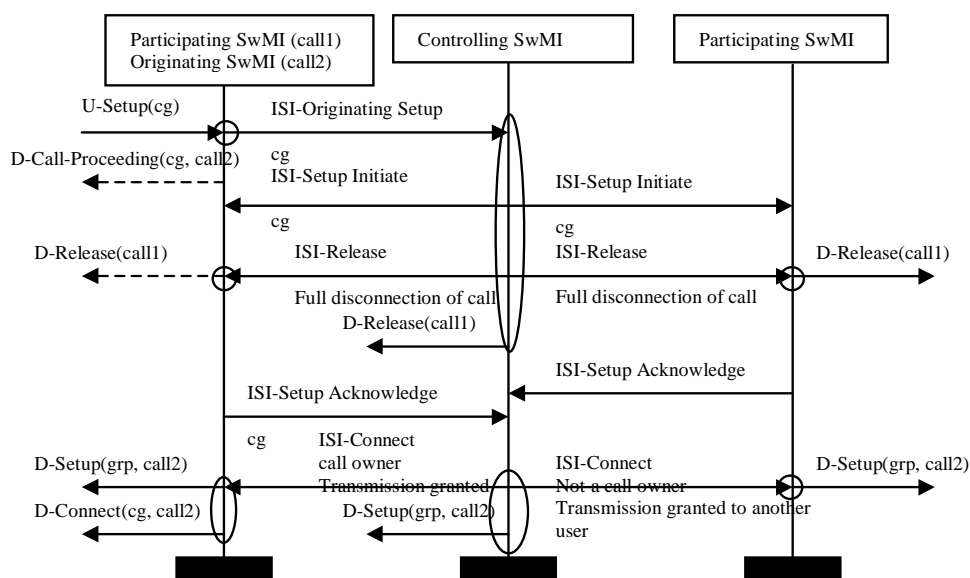
Figure E.16: A Party joins with an Active Call

## Description

On receiving an ISI-ORIGINATING-SETUP PDU for a group call that is already connected, the CSwMI may allow the party to join in with the existing call. It does this by initiating a call with joining SwMI only.

### E.1.17 An emergency priority call to a group that is already in an active, non-emergency, call

- CSwMI connects when an OSwMI is ready. Refer to E.17.



NOTE 1: The PSwMIs, CSwMI are already in a group call (call1) that is called by the party at the OSwMI at an emergency priority.

NOTE 2: The CSwMI attempts to set up the new call and clear down the existing call. The OSwMI may, optionally, already have cleared the original call locally, before being prompted to do so by the CSwMI.

NOTE 3: Each of the calls uses a different PSS1 connection.

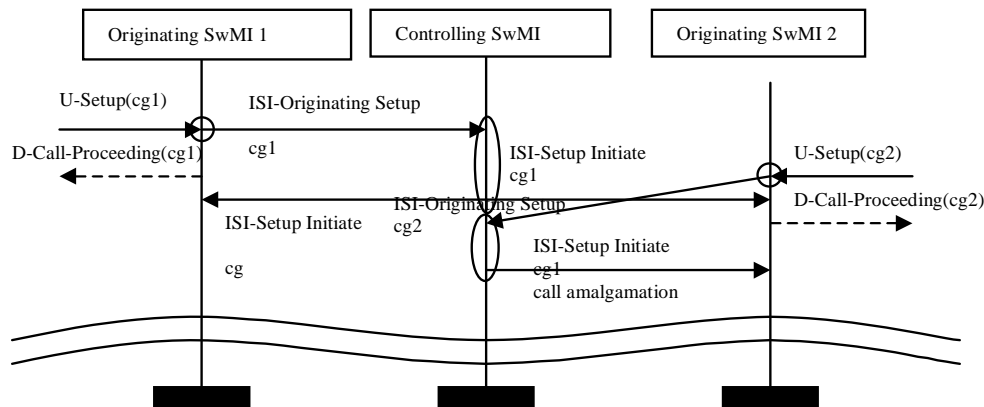
**Figure E.17: An emergency priority call to a group that is already active in a call**

## Description

On receiving an ISI-ORIGINATING-SETUP PDU, at an emergency priority, for a group call that is already connected, at a non emergency priority, the CSwMI clears down the existing call while setting up the new one.

## E.1.18 A call collision at startup

Refer to figure E.18.



- NOTE 1: If the CSwMI receives an ISI-ORIGINATING-SETUP PDU just after it has sent an ISI-SETUP-INITIATE PDU to the same SwMI, for the same call, then it will respond with an ISI-SETUP-INITIATE PDU with the "amalgamation" information element set to "call has been amalgamated". Two PSS1 connections will have to be used in this case and each of the ISI-SETUP-INITIATE PDU will have been sent down separate PSS1 connections.
- NOTE 2: Two ANF instances for the same call will be active in OSwMI 2. The receipt of the second ISI-SETUP-INITIATE PDU, with the "call amalgamation" field set, to the instance of the calling party, causes it to search for, and merge with the other ANF instance. Only the PSS1 connection of the first ISI-SETUP-INITIATE PDU is now used for the call and the second PSS1 connection is cleared down by the CSwMI when the ISI-SETUP-INITIATE PDU was sent.
- NOTE 3: The call then proceeds in the normal way, with two OSwMIs.

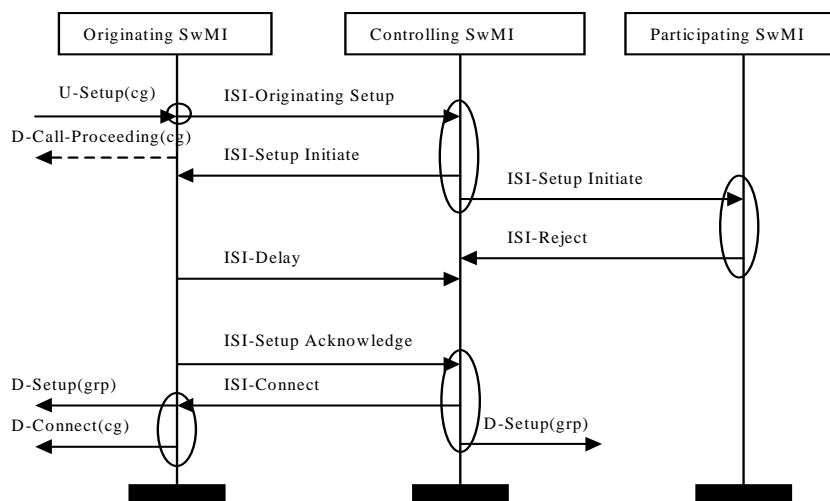
**Figure E.18: A call collision at startup**

### Description

A call continues when two parties attempt to setup the same call at the same time.

## E.1.19 Partial successful group call establishment, call is not accepted by a PSwMI

- CSwMI connects when an OSwMI is ready. Refer to figure E.19.



NOTE 1: A group call can continue if any PSwMI that should be part of the call declines to be part of it.

NOTE 2: The group call may be released by the CSwMI if the CSwMI determines that the removal of the SwMI from the call results in no called group members being in the call.

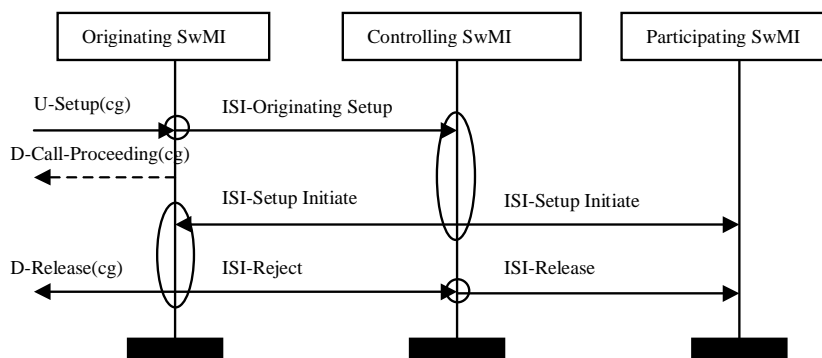
**Figure E.19: Partial successful group call setup, Call is not accepted by a PSwMI**

### Description

If an ISI-REJECT PDU is received in response to an ISI-SETUP-INITIATE PDU sent to a PSwMI then the CSwMI shall remove the rejecting SwMI from the SwMIs in the group call.

## E.1.20 Unsuccessful group call establishment rejected by an OSwMI

Refer to figure E.20.



NOTE 1: A group call does not continue without an OSwMI (unless the OSwMI is also the CSwMI).

NOTE 2: The CSwMI may have already been notified that there is another OSwMI, via an ISI-ORIGINATING-SETUP PDU. If the CSwMI supports multiple calling parties then, when the ISI-REJECT PDU is received, the call is allowed to continue since it is being initiated by another SwMI located elsewhere. In this case the other SwMIs in the call are NOT sent an ISI-RELEASE PDU.

**Figure E.20: Unsuccessful group call establishment, rejected by an OSwMI**

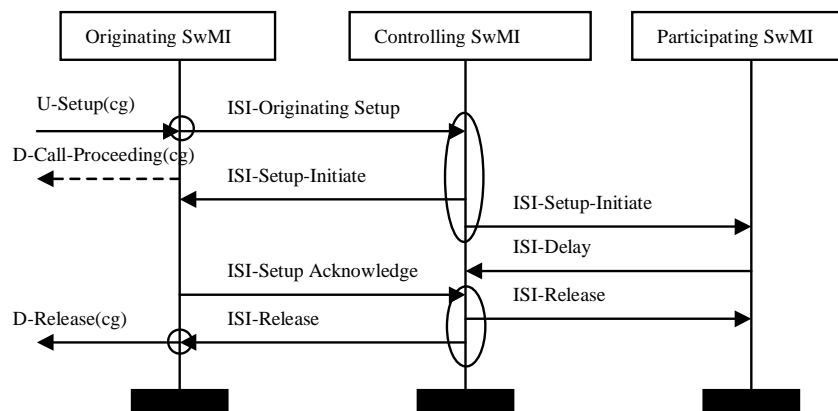


### Description

If an ISI-REJECT PDU is received from the OSwMI that has previously received an ISI-SETUP-INITIATE PDU and there are no other calling parties then the group call cannot continue. All remaining SwMIs are released from the group call by being sent an ISI-RELEASE PDU.

## E.1.21 Unsuccessful group call establishment, the CSwMI cannot accept some parameters, such as *resource allocation*, in the ISI SETUP ACKNOWLEDGE PDU from an OswMI

Refer to figure E.21.



NOTE 1: In the case of a PSwMI that sends incompatible arguments, the CSwMI may release the PSwMI from the call, but allow the call to continue. The call continues, provided that the CSwMI does not determine that there are no group members in the call.

NOTE 2: If the call has other OSwMIs (the CSwMI has received at least one other ISI-ORIGINATING-SETUP PDU) when the ISI-SETUP-ACKNOWLEDGE PDU arrives, then there is no need for the CSwMI to release the whole call. Only the SwMI sending the incompatible ISI-SETUP-ACKNOWLEDGE PDU needs to be released.

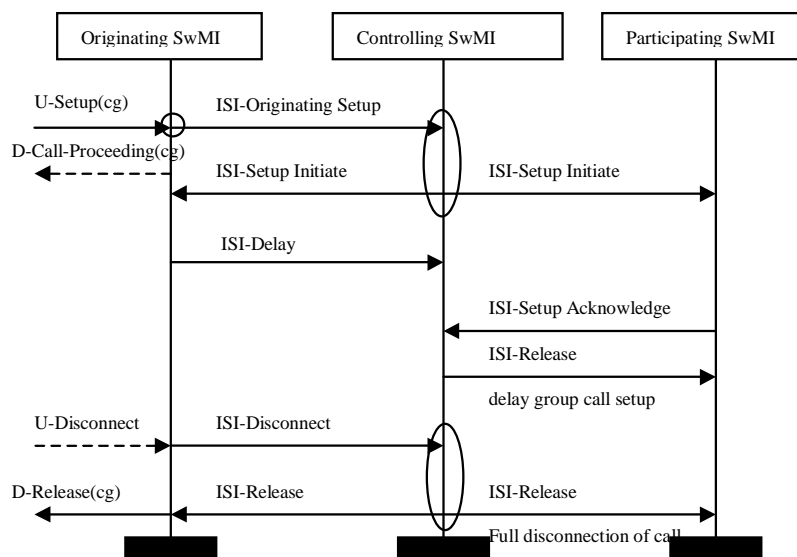
**Figure E.21: Unsuccessful group call establishment, the CSwMI cannot accept some parameters in the ISI SETUP ACKNOWLEDGE PDU from an OswMI**

### Description

If a SwMI that hosts a calling party requests a communication type that is different from *point-to-multipoint*, or a resource allocation policy that it does not support, in its **ISI-SETUP-ACKNOWLEDGE** PDU then the call may be cleared by the **CSwMI**. This is achieved by sending an **ISI-RELEASE** PDU to all SwMIs.

## E.1.22 Unsuccessful Group Call Establishment, OSwMI or Party times out

Refer to figure E.22.



NOTE 1: If the call setup timer is exceeded before the call is successfully set up, then the OSwMI will disconnect the call.

NOTE 2: The OSwMI will indicate whether the call is clearing in the SwMI by disconnecting, or not disconnecting, the underlying PSS1 connection. The CSwMI will send an ISI-RELEASE PDU to the OSwMI, to release the SwMI from the call, if the underlying PSS1 connection was disconnected. If there are no other OSwMIs all SwMIs, including the OSwMI, are released from the call and the PSS1 connection disconnected.

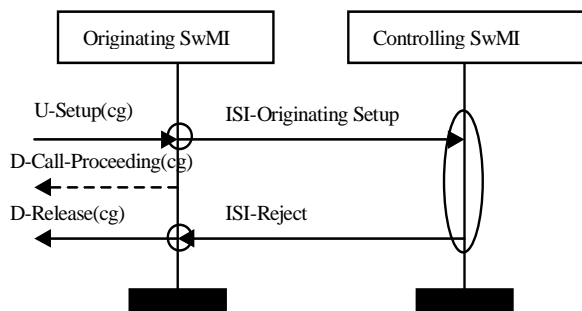
**Figure E.22: Unsuccessful group call establishment, OSwMI or owing Mobile times out**

### Description

An ISI-DISCONNECT PDU sent from an OSwMI during the group call setup phase may cause the call to be cleared. This is achieved by sending an ISI-RELEASE PDU to all SwMIs in the call.

## E.1.23 Unsuccessful group call establishment rejected by the CswMI

Refer to figure E.23.



**Figure E.23: Unsuccessful group call establishment, rejected by the CSwMI**

### Description

An ISI-REJECT PDU is sent in response to an ISI-ORIGINATING-SETUP PDU that cannot be accepted by the CSwMI.

## E.2 Call maintenance

NOTE: For the present version of the present document only a permanently allocated resource policy is supported. The information element "Resource allocation" is always set to "Permanently allocated resources".

Refer to figure E.24.

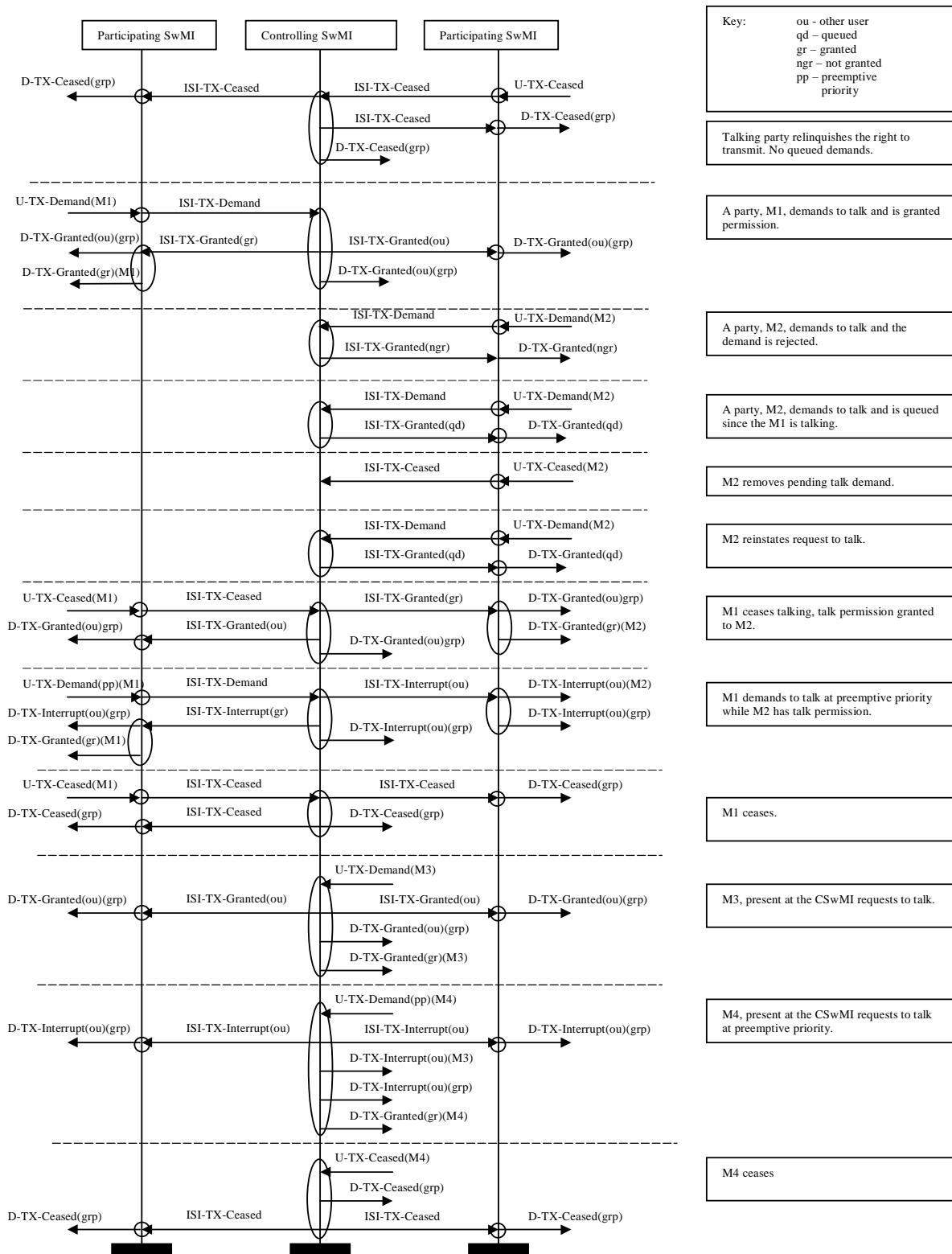


Figure E.24: Call maintenance

NOTE 1: There could be one or more PSwMIs.

NOTE 2: One of the PSwMI may also be the OSwMI.

NOTE 3: There will be no air interface signalling at the CSwMI if there are no group members present there.

NOTE 4: When an ISI-TX INTERRUPT (gr) PDU is received a SwMI must send both an air interface D-TX INTERRUPT (ou) PDU to the group and a D-TX GRANTED (gr) PDU to the granted party. Also note 5 applies.

NOTE 5: When an ISI-TX INTERRUPT PDU is received a SwMI must send an air interface D-TX INTERRUPT (ou) PDU to the previous talking party, if the party was present at the SwMI, prior to sending a D-TX INTERRUPT (ou) PDU to the group. In the case of an ISI-TX INTERRUPT (gr) PDU this could result in up to three air interface PDUs being sent as the result of a single ISI PDU.

NOTE 6: When an ISI-TX GRANTED (gr) PDU is received, the receiving SwMI must send an air interface D-TX GRANTED (gr) PDU to the party receiving transmit permission and a D-TX GRANTED (ou) PDU to the group address of any other group members.

NOTE 7: ISI-DEMAND-RESPONSE PDU is not used since its contents can be carried in a D-TX GRANTED PDU. This makes the maintenance protocol closer to the maintenance protocol used with individual calls.

NOTE 8: ISI-TX WAIT and ISI-TX CONTINUE PDUs will be supported in future releases only.

### **Description**

When the current talking party relinquishes talk permission an ISI-TX CEASED PDU is sent to the CSwMI. If the CSwMI ascertains that no other Group Member has requested transmit permission it informs both the original talking parties SwMI, and all other PSwMIs that there is now no talking party in the call via an ISI-TX CEASED PDU. If the CSwMI determined that there was another party requiring transmit permission then an ISI-TX GRANTED (gr) PDU is sent to the PSwMI of the granted party and an ISI-TX GRANTED (ou) PDU to all other PSwMIs.

A request is sent to the CSwMI for transmit privilege for a party using an ISI-TX DEMAND PDU. If the CSwMI ascertains that no other Group Member has transmit permission it is granted to the requesting user's SwMI via an ISI-TX GRANTED (gr) PDU. In addition, in order that all other Group Members may be informed that the call now has a talking party, all other Participating SwMIs are sent an ISI-TX GRANTED (ou) PDU. If the transmit request queue at the CSwMI is full, the CSwMI may reject the demand. If the CSwMI ascertains that a current group member has transmit permission, and the demand is not at a pre-emptive priority, then the CSwMI may queue the demand. To indicate that this has happened an ISI-TX GRANTED (qd) PDU is sent to the demanding SwMI.

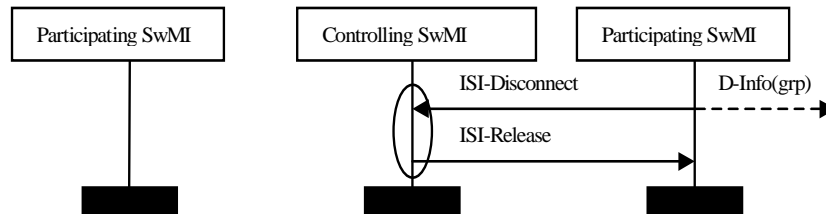
An ISI-TX CEASED PDU is used by a non-talking party whose intention is to remove a queued demand. In this case the CSwMI does not respond to the ceasing SwMI.

When a demand to transmit is received at pre-emptive priority the CSwMI indicates that the demanding SwMI is granted transmit permission via an ISI-TX INTERRUPT (gr) PDU. In order that all other SwMIs can be told that the call has a new talker an ISI-TX INTERRUPT (ou) PDU is sent to the other SwMIs.

## E.3 Call termination

### E.3.1 The release of a SwMI from a call

Refer to figure E.25.



NOTE 1: The call may be cleared if the CSwMI can determine that the withdrawal of a SwMI results in there being no group members in the call.

NOTE 2: The ISI-DISCONNECT PDU may be sent in a PSS1-DISCONNECT or a PSS1-FACILITY message. In the PSS1-DISCONNECT message case the PSwMI is no longer in the call and the CSwMI will automatically respond with ISI-RELEASE PDU. In the PSS1-FACILITY message case the CSwMI decides if the PSwMI is to remain in the call, it therefore may, or may not, respond with the ISI-RELEASE PDU.

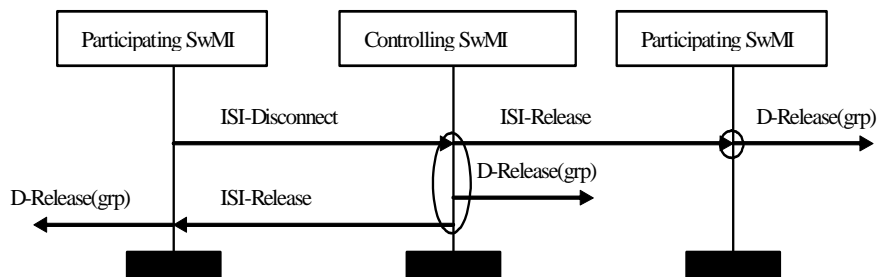
**Figure E.25: The release of a PSwMI from an ongoing call**

#### Description

The CSwMI may continue with a call where one of the PSwMIs drops out of the call.

### E.3.2 Call disconnection, as a result of a PSwMI disconnecting

Refer to figure E.26.



NOTE: The ISI-DISCONNECT PDU may be sent in either a PSS1-DISCONNECT or a PSS1-FACILITY message.

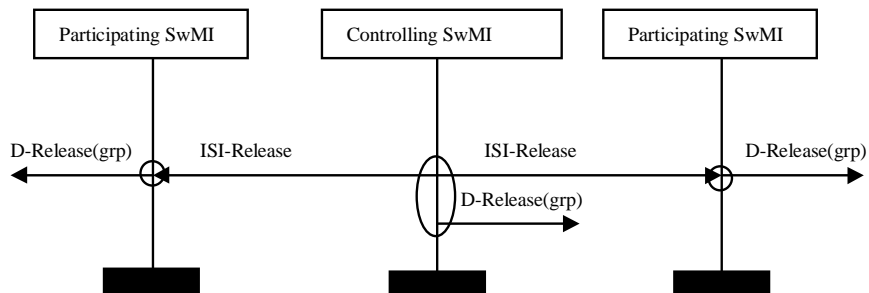
**Figure E.26: Call Disconnected**

#### Description

The CSwMI may decide to clear a call when a PSwMI withdraws from it.

### E.3.3 Call disconnection by the CswMI

Refer to figure E.27.



NOTE: This is the usual way for a call to be released if it is a call with a short hang time.

**Figure E.27: Call Disconnected by the CSwMI**

#### Description

The CSwMI has the right to close down a group call if needed. To do this it sends ISI-RELEASE PDU to all SwMIs in the call.

---

## Annex F (informative): Justification for the recommended call connection strategies and control of which parties are in the call

The conditions used by a CSwMI to decide when to connect the call and the conditions used by an OSwMI or PSwMI to send back its ISI-SETUP-ACKNOWLEDGE PDU are flexible and are not prescribed in the present document. However the following strategy is recommended:

- An OSwMI to send in its ISI-SETUP-ACKNOWLEDGE PDU when it has resources to allow a calling party to be connected into the call. The calling party that is ready to connect is indicated in the ISI-SETUP-ACKNOWLEDGE PDU. A PSwMI that becomes an OSwMI because it hosts a new calling party also follows this rule.
- The CSwMI to connect the call when it has an OSwMI that has sent in its ISI-SETUP-ACKNOWLEDGE PDU, and thus a calling party, is ready.

These rules, together, ensure that a call cannot be connected without a calling party and that the call is set up as soon as is practical. It could mean (but unlikely) that there is not a called party in the call.

The strategy to be used by a PSwMI is recommended to be:

- To send back its ISI-SETUP-ACKNOWLEDGE PDU as soon as it has determined that called group members exist at the PSwMI.

This strategy allows the PSwMI's parties to be connected into the call, as soon as resources are available for them, and the CSwMI has decided to connect the call. Adopting this rule minimizes the chances, that a PSwMI's parties, that could be connected into a call, are not connected since the PSwMI has not replied to the CSwMI with an ISI-SETUP-ACKNOWLEDGE PDU. The CSwMI may send a delaying SwMI an ISI-INFO PDU to tell it that the call has connected, further minimizing the problem.

Manufacturers should be aware that the adoption of other strategies can lead to anomalies and non-efficient call setup. As an example, let us suppose that the strategy of an OSwMI, which also hosted called parties, was to send back its ISI-SETUP-ACKNOWLEDGE PDU only when resources for its calling party and at least one called party were available. The strategy of the CSwMI was to connect only when it had both an OSwMI and a PSwMI in the call. These strategies could be adopted in order to ensure that there is a called party in the call when it connects. Example anomalies are as follows:

- The calling party could have obtained resources so that it can be connected into the call and there may be called parties with resources on other SwMIs. This should satisfy the conditions to connect the call. However, because the OSwMI does not send in its ISI-SETUP-ACKNOWLEDGE PDU, since it has no ready called party, the CSwMI has no knowledge of the OSwMI being ready for connection and so will not connect the call.
- Even if an OSwMI, with calling parties, had sent back its ISI-SETUP-ACKNOWLEDGE PDU the call may not be connected immediately. This occurs when the CSwMI does not have a PSwMI ready to fulfil its conditions for connection. The call could actually have been connected since there is a called party ready at the OSwMI. However, the CSwMI does not know this from the signalling.

These issues are compounded by the releasing mechanism. This is because if the call is not connected when it really could have been the CSwMI will release all of the SwMIs, which have sent in ISI-SETUP-ACKNOWLEDGE PDU from the call. There is therefore no guarantee that the released resources can be obtained again when the resource that is being waited for becomes available.

Another reason for the recommendation of the CSwMI connection strategy is that the recommendation does not rely on having a PSwMI in the call before connecting. If it did, the strategy used would have to be flexible to allow a different rule to be used when there was no PSwMI in the call. It would also need to be dynamic, and modify its rule, when a PSwMI that is in the call changes into an OSwMI.

---

## Annex G (informative): Bibliography

- ITU-T Recommendation I.112 (1993): "Vocabulary of terms for ISDNs".
- ETSI TR 102 300-5: "Terrestrial Trunked Radio (TETRA); Voice plus Data (V+D); Designers' guide; Part 5: Guidance on numbering and addressing".



## Annex H (informative): Change Requests

The present version of the present document includes Change Requests as described in table H.1.

NOTE: In some cases change requests may modify earlier change requests but that is not reflected back to the earlier change requests. The later change request is applied into the standard.

**Table H.1: Change Requests**

No	CR vers.	Standard Version	Clauses affected	Title	CR Status
001	10	ed. 1	6.3.1.1.1.2	The Length of Number of external group member identities in table 25 is missing. (ISI-SETUP INITIATE PDU)	WG3 approved 030414
002	10	ed. 1	5.2.2.5, 5.2.2.13, 6.3.1.1.1.1, 6.3.1.1.1.2, 6.3.2.2.4A (new) and 6.3.2.2.17B (new)	Addition of GTSI to ISI-ORIGINATING SETUP and ISI-SETUP INITIATE PDUs	WG3 approved 030414
003	10	ed. 1	6.3.1.1.3.1	ISI-CONNECT PDU encoding correction	WG3 approved 030414
004	10	ed. 1	6.3.1.1.3.11	Correction of the PDU encoding of the ISI-TX GRANTED	WG3 approved 030414
005	10	ed. 1	6.3.1.1.2.1, 6.3.1.1.3.3, 6.3.1.1.3.4 and 6.3.2.2.17A (new)	Modified PDU encoding for ISI-INFO PDUs	WG3 approved 030414
006	10	ed. 1	6.3.1.1.2.3	ISI Delay PDU in PSS1 Facility PDU	WG3 approved 030414
007	01	ed. 1	4.2.2.3, 5.2.1, 6.5.1, 6.5.4	Withdrawing calling MS	Withdrawn
008	10	ed. 1		Changes to ANF-ISI-GC due to SS-CF	WG3 approved 030414
009	10	Ed. 1	3.2, 4.2.2.3.1, 4.2.2.3.2, 4.2.2.3.3, 4.4.13, 5.2.2.5, 6.3.1, 6.3.2, 6.5.1, 6.5.3, 6.5.4, 6.5.6 (new section), 6.7.3, Annex F (new section), Annex H (new section)	Alignment of the ETSI ANF-ISIGC with the approved MoU ISI GC TIP TTR 003-06 v0.9.0 February 2003	WG3 approved 030513
010	10	Ed.1	4.2.2.3.1, 5.2.2.5, 5.2.2.11, 6.3.1.1.1.1, 6.3.1.1.6.1, 6.5.1.2	Group linking	WG3 approved 030513
011	02	Ed. 1	6.3.1.1.2.2	ISI-SETUP-ACKNOWLEDGE	WG3 approved 030613
012	01	Ed. 1	6.3.1.1.3.1	Call amalgamation	WG3 approved 030613
013	01	Ed. 1	6.3.1.1.1.2	Missing "selected area number" in ISI-SETUP INITIATE PDU and misleading SS-CI information	WG3 approved 030613
101	12	V1.2.1	6.3.2.1.3	Group call specific disconnection causes	WG3 approved 100202
102	10	V1.2.1	4.2.2.3.1, 4.2.2.3.2, 4.2.2.3.4, 5.2.1.1, 5.2.2.3, 5.2.2.13, 6.3.1.1.1.2, 6.3.1.1.2.2, 6.3.1.1.3.1, 6.3.2.1.1.a, 6.3.2.2.26a, 6.5.1.7, 6.5.1.9	Call set-up PDU modifications	WG3 approved 100629
103	10	V1.2.1	6.3.2.1.3, 6.3.2.2.22	Group call specific reject causes	WG3 approved 100908
104	10	V1.2.1	6.3.2.2.22	Group call specific reject causes alignment	WG3 approved 101008
105	10	V1.2.1	4.6	Description using attributes	WG3 approved 101116

No	CR vers.	Standard Version	Clauses affected	Title	CR Status
106	10	V1.2.1	6.3.2.2.26	Security level alignment with EN 300 392-7	WG3 approved 110121
107	10	V1.2.1	4.2.2.3.6, 5.2.2.3, 6.3.1.1.3.1, 6.3.2.2.4a, 6.5.1.8.3	Call connect PDU modifications	WG3 approved 110210

---

## History

<b>Document history</b>		
Edition 1	March 2000	Publication as ETS 300 392-3-3 (Historical)
V1.2.1	January 2004	Publication
V1.3.0	July 2011	One-step Approval Procedure      OAP 20111105: 2011-07-08 to 2011-11-07
V1.3.1	November 2011	Publication